



Purchase 20 Vargus inserts in any combination and receive a BONUS **ALCN** toolholder!

Only purchases of ALCN inserts listed on redemption are eligible for bonus holder

External Thread Turning Toolholders

With two high pressure coolant outlets

Vargus order #	Vargus item#	MSC #	Vargus order #	Vargus item#	MSC #
3ER1.0ISOVTX	53609	78592938	3ER16UNVTX	51451	79033510
3ER1.5ISOVTX	51077	74227430	3ER18NPTVTX	51478	43568955
3ER10STACMEVTX	51125	78357936	3ER18UNJVTX	51495	75194704
3ER10UNVTX	51144	85431963	3ER18UNVTX	51511	08171746
3ER11.5NPTVTX	51213	68869338	3ER2.0ISOVTX	51547	51470177
3ER11.5UNVTX	53533	46807764	3ER20UNJVTX	51576	75194720
3ER11UNVKX	51174	82740515	3ER20UNVTX	51591	51581874
3ER11UNVTX	51175	93969962	3ER24UNJVTX	51609	75194670
3ER11WVTX	51186	76249010	3ER24UNVTX	51623	88596721
3ER12ABUTVTX	51240	51719409	3ER28UNJVTX	51683	66737388
3ER12ACMEVTX	53833	93707024	3ER28UNVTX	51697	93974467
3ER12STACMEVTX	51260	82477241	3ER32UNJVTX	53652	79839692
3ER12UNJVTX	51272	78708823	3ER32UNVTX	51746	51581940
3ER12UNVTX	51291	43707488	3ER6STACMEVTX	53828	51596740
3ER13UNVTX	52889	59494880	3ER8ACMEVTX	53892	08171431
3ER14NPTVTX	51352	51581981	3ER8STACMEVTX	51904	55503718
3ER14STACMEVTX	63387	93969772	3ER8UNVTX	51924	75445429
3ER14UNJVTX	51369	78708781	3ERA60VTX	50973	68218528
3ER14UNVTX	51383	43707496	3ERAG60VTX	50953	62263744
3ER16UNJVTX	51433	08171340	3ERG60VTX	50993	41244237

Features and Benefits

- Precise coolant thru, designed to efficiently cool down the cutting edge
- Suitable for high pressure coolant (up to 70 bar)
- Reduced cutting edge temperature for better tool life
- Better chip evacuation and improved chip control and flow
- External holders with coolant are fully supported by VARGUS GENius™, the most advanced Tool Selector and CNC Program Generator in the metal cutting tools industry

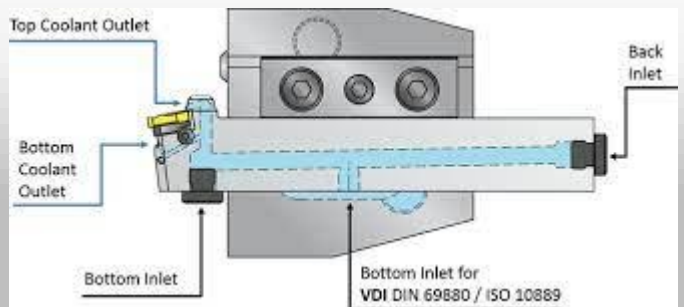

Compatible Vargus Holders, listed below – indicate which holder you would like to receive

MSC item #	VI #	Description - Standard ALCN holder Vargus	mark box for bonus size selected
90343096	001-00924	Vargus Thread Turning Standard Holders EX RH 1" (Inch)x1" (Inch) Shank, Insert Compatibility for 4ER	
90343112	001-00925	Vargus Thread Turning Standard Holders EX RH 1.25" (Inch)x1.25" (Inch) Shank, Insert Compatibility for 4ER	
90343088	001-00928	Vargus Thread Turning Standard Holders EX RH 1" (Inch)x1" (Inch) Shank, Insert Compatibility for 5ER	
90343153	001-00929	Vargus Thread Turning Standard Holders EX RH 1.25" (Inch)x1.25" (Inch) Shank, Insert Compatibility for 5ER	
90343104	001-00935	Vargus Thread Turning Standard Holders EX LH 0.75" (Inch)x0.75" (Inch) Shank, Insert Compatibility for 3EL	
90343120	001-00936	Vargus Thread Turning Standard Holders EX LH 1" (Inch)x1" (Inch) Shank, Insert Compatibility for 3EL	
90343070	001-00940	Vargus Thread Turning Standard Holders EX LH 1" (Inch)x1" (Inch) Shank, Insert Compatibility for 4EL	
90343179	001-00950	Vargus Thread Turning Standard Holders EX RH 0.625" (Inch)x0.625" (Inch) Shank, Insert Compatibility for 3ER	
90343138	001-00951	Vargus Thread Turning Standard Holders EX RH 0.75" (Inch)x0.75" (Inch) Shank, Insert Compatibility for 3ER	
90343161	001-00952	Vargus Thread Turning Standard Holders EX RH 1" (Inch)x1" (Inch) Shank, Insert Compatibility for 3ER	
90343146	001-00953	Vargus Thread Turning Standard Holders EX RH 1.25" (Inch)x1.25" (Inch) Shank, Insert Compatibility for 3ER	

Please print clearly

MUST include copy of purchase order from MSC – redemptions without a copy of MSC purchase order will not be fulfilled

First Name: _____ Last Name: _____

Company Name: _____

Email address: _____

Phone Number: _____

Mailing address (no PO boxes):

Street: _____

City: _____ State: _____ Zip: _____

• **Email redemption form to:** hlaidig@vargususa.com

- Offer valid on purchases made thru MSC only
- Offer valid on purchases made thru 7/31/21
- Cannot be combined with any other offer
- Limited time offer while supplies last
- Offer valid only in the forty-eight (48) contiguous United States (excluding Alaska and Hawaii)
- Limit of two (2) redemptions per purchase order per mailing address
- Void where prohibited by law
- Redemption requests must be received by 8/15/21
- All fields must be completed; incomplete or ineligible forms will not be processed
- Allow 4-6 weeks for delivery

Call MSC today to learn about Vargus items.
800.645.7270 | mscdirect.com

Available
today at

