

Eaton

Steel adapters and swivel joints catalog

Welcome to the higher standard: Steel adapters and swivel joints

Higher pressure. Higher performance.
Beyond SAE certified.



EATON

Powering Business Worldwide



One Eaton-branded steel adapter product line with up to 35% more configurations.

Choose your components wisely.

Expand the equation

As one of the most trusted brands for quality, dependability, and service, we're further evolving our steel adapter's portfolio to deliver you even greater options along the highest performing, most reliable adapters in the market. By merging the Aeroquip™ and Weatherhead™ adapters into one Eaton-branded product line, you now have access to more adapter configurations - up to 35% more - to help meet your next design challenge.

Achieve operating pressures up to 50% more than SAE.



Discover the additional value of using an Eaton system of products designed to work together to achieve even higher operating pressures. When Eaton hoses are combined with Eaton TTC, Z-Series, or 4S/6S fittings and Eaton adapters, assemblies can perform up to 50% higher pressures than the SAE rating.

The Eaton Assembly Advantage

Engineered to Exceed

Eaton hose, fitting and adapter assembly, engineered with Eaton equipment and crimp specs provides the ultimate in reliability and performance.



LESS LEAKS



LESS COST



LONG LIFE

The Dura-kote edge

Eaton adapters come with Dura-Kote plating, which gives you up to 1,000 hours of corrosion resistance. Dura-Kote is an innovative plating technology for steel adapters, offering more corrosive protection for longer life, lower replacement costs, and improved appearance. This corrosion protection decreases the likelihood of leaking, which means less equipment downtime and greater productivity.

650 hours salt spray • ASTM B117



In a 650 hours salt spray test Eaton's family of components showed no corrosion migration in comparison to an assembly that combined an Eaton fitting with competitor components. This test illustrates why it is so important to choose Eaton components for your entire hose assembly.

Eaton adapter part numbers made simple.



Finding and cross-referencing

Finding the new Eaton adapter number is easy using the cross reference tool on EatonPowerSource.com

Just type in the former Weatherhead and Aeroquip part numbers or competitive products to find the new Eaton-branded part number.



How to read Eaton adapter part numbers

Adapter part numbers

Adapter part numbers consist of a base number followed by a size designation. If the part number contains a "T" character between the base number and size designator, the first size designator signifies the tube size.

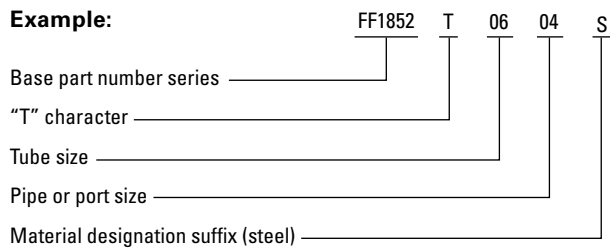

If the part number does not contain a "T" character between the base number and the size description, the first size designation signifies the port size.

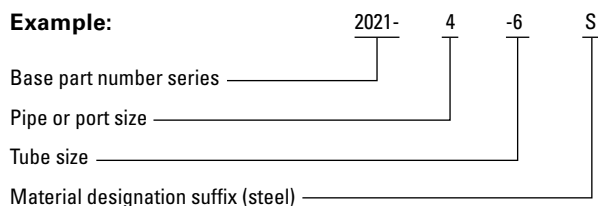

How to order Eaton adapters

Ordering adapters

Adapters are ordered using the complete part number as shown on the adapter pages.

2021
formerly
WH C5205X6

Example: 2021- 4 -6 S

Above example represents former Weatherhead part number C5205X6 for the new equivalent 2021 Eaton series adapter.

Make sure you are following the guides shown on pages 27-28 as all adapter part numbers do not follow the same numbering logic.

Regardless of the job, Eaton has the right products to meet the challenge every time.

Additional products available from Eaton.



Eaton Brass Adapters

Precision-machined, SAE-approved Eaton brass adapters are manufactured out of durable UNS C36000 brass. This provides outstanding corrosion resistance for a variety of applications from air brake to hydraulic and pneumatic systems. Large, uniform wrench pad areas have standard dimensions for easy assembly and disassembly using standard open-end wrenches.

Some of the available brass adapters include:

- SAE 45° flare
- Pipe
- Air brake
- Polyline flareless
- Selfalign
- Drain cocks
- Valves
- Molded tube compression
- Plastic tubing
- And many more

Check out our complete portfolio of **Brass Adapters** found in our catalog located on eatonpowersource.com

Literature number: **E-BRFI-MC001-E6**



Walterscheid Metric Tube Fittings

Making the right connections is easy with Eaton's Walterscheid metric tube fittings. A variety of available sizes and configurations make Eaton's metric tube fittings a simple, flexible and cost-effective solution for many applications. With three unique systems—including WALPro, WALRing and WALForm—each tube fitting is manufactured to meet DIN 2353 and ISO 8434-1 standards and withstand pressure and corrosion with best-in-class performance

Metric tube fitting applications:

- Harvester/balers
- Machine tool
- Hydraulic presses
- Excavators
- Loaders
- Mining equipment
- Concrete pumps
- Off-shore equipment

Learn more about Eaton's entire line of metric tube fittings by reviewing our **Walterscheid Metric Tube Fittings** catalog found on eatonpowersource.com

Literature number: **E-MEFI-MC002-E1**



Eaton STC Snap-To-Connect

Patented STC Snap-To-Connect products are threadless connectors that keep equipment up and running longer with simple, leak-free connections.

Eaton has the broadest range of threadless connectors in the industry, and our patented STC technology excels in rigorous mobile applications in agriculture, construction, forestry, transportation, utility and lawn and turf. Because of their easy installation even in confined spaces, and virtually zero-leak performance (per SAE J1176), more than 25 million STC connections are currently in use worldwide.

STC benefits:

- Fast reliable one-hand connections requiring no assembly tools
- Eliminates cross-threading, over or undertorquing, and hose twisting
- Virtually zero leak performance
- Direct porting eliminates adapters to maximize cost savings
- Resists external contamination
- Allows easy disconnection with release tool

A full list of available **STC products** can be found in our catalog located on eatonpowersource.com

Literature number: **E-MEFI-MC003-E2**



Table of contents

Application data

How to identify fluid connectors	2
Thread size chart	3
How to measure non-thread connectors	4

Connections

American connections	4
ISO Connections	7
German connections	9
French connections	12
British connections	12
Japanese connections	13

Thread engagement nominal dimensions	16
--	----

Pressure performance

SAE Thread style	18
All Eaton	19

Tubing Applications

Maximum operating pressures	20
Recommended wall thickness	21

Assembly torque

Recommended parallel connection	22
---	----

Assembly instructions

ORS, pipe threads and SAE 37° tube fittings	24
Adjustable SAE O-Ring boss	26

How to order adapters	27
---------------------------------	----

Adapters

Configuration index	29
ORS connections	39
ORS-TF	40
ORS-Braze type	41
ORS/SAE O-Ring boss	44
ORS-NPTF	49
ORS to SAE 37° flare	51
ORS/ORS	52
ORS accessories	56
SAE O-Ring boss/SAE O-Ring boss	58
Pipe to pipe	61

Pipe to SAE 37° flare	77
Pipe to 45° flare	89
Pipe to SAE O-Ring boss	91
Pipe to braze and weld	94
SAE 37° flare union	94
SAE 45° flare union	103
SAE O-Ring boss to SAE 37° flare	104
Split flange O-Ring and kits	109
SAE split flange to ORS	114
SAE split flange to SAE 37° flare	116
SAE swivel flange to SAE split flange	119
SAE flareless to SAE 37° union	120
Braze and weld to split flange	121
Braze and weld to SAE 37° flare	123
Versil-Flare™ – flareless and flared	124
Specials	128
Metric thread dimensions	130
Metric to SAE 37° flare	131
ORS to metric	134
Pipe to metric	135
BSPP to SAE 37° flare	136
BSPT to SAE 37° flare	137
JIS 30° to SAE 37° flare	138
7000 series Ermeto	139

Swivel joints

Swivel joints	153
FS6500	154
FS5900	161
Repair kit	163

Cross reference index	165
--	------------



Steel adapters

Fluid connectors identification

Fluid connectors identification

Measuring Tools: A seat angle gauge, thread pitch gauge and an I.D./O.D. caliper are necessary to make accurate measurements of commonly used connectors. Eaton offers a unique new caliper than offers the capabilities of both a caliper and a seat angle gauge in one unit.



FT1341

Identification Tool Kit

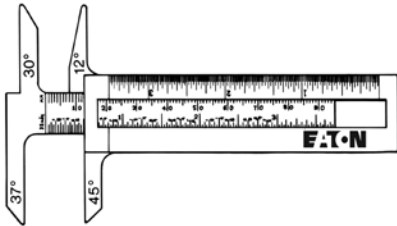

I.D./O.D. Angle gauge caliper

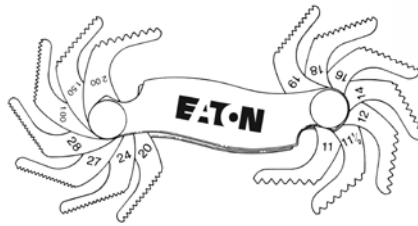

Thread pitch gauge

How to measure threads

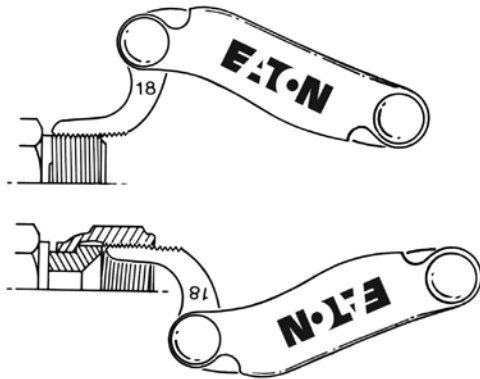

Use a thread pitch gauge to determine the number of threads per inch or the distance between threads in metric connections. Place the gauge on the threads until the fit is snug. Match the measurement to the charts.

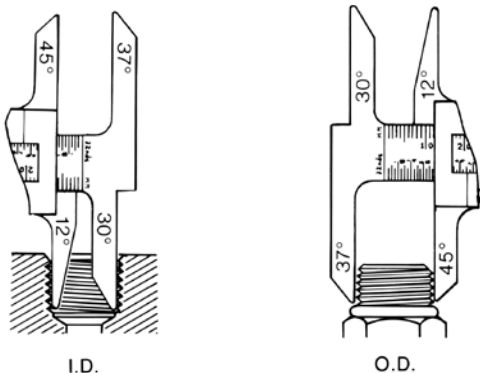

Measure the thread diameter with an I.D./O.D. caliper as shown. Match the measurements to the charts.

How to measure sealing surface angles

Female connections are usually measured by inserting the gauge into the connection and placing it on the sealing surface. If the centerlines of the connection and gauge are parallel, the correct angle has been determined.

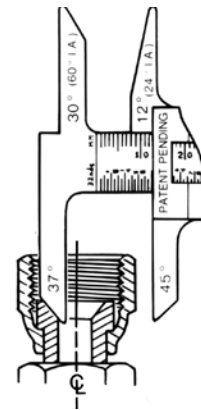

Male flare type connectors are usually measured by placing the gauge on the sealing surface. If the centerlines of the connection and gauge are parallel, the correct angle has been determined.

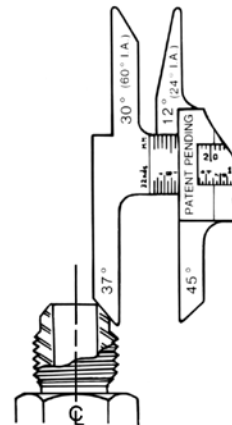

Thread size chart

The following chart is intended as a quick reference guide for thread size by dash size.

Dash size	N.P.T.F.	N.P.S.M. approx. dia.	SAE 45° auto. refriger.	SAE 37° (J.I.C.) hydraulic	SAE O-Ring boss	P.T.T. 30° automotive	SAE invert. flare	ORS
-02	1/8-27	1/8-27	5/16-24	5/16-24	5/16-24	-	5/16-24	-
-03	-	-	3/8-24	3/8-24	3/8-24	-	3/8-24	-
-04	1/4-18	1/4-18	7/16-20	7/16-20	7/16-20	-	7/16-24	9/16-18
-05	-	-	1/2-20	1/2-20	1/2-20	-	1/2-20	-
-06	3/8-18	3/8-18	5/8-18	9/16-18	9/16-18	-	5/8-18	11/16-16
-07	-	-	11/16-24	-	-	-	11/16-18	-
-08	1/2-14	1/2-14	3/4-16	3/4-16	3/4-16	-	3/4-18	13/16-16
-10	-	-	7/8-14	7/8-14	7/8-14	-	7/8-18	1-14
-12	3/4-14	3/4-14	1 1/16-14	1 1/16-12	1 1/16-12	-	1 1/16-16	1 3/16-12
-14	-	-	-	1 3/16-12	1 3/16-12	-	-	-
-16	1-11 1/2	1-11 1/2	-	1 5/16-12	1 5/16-12	1 5/16-14	-	1 7/16-12
-20	1 1/4-11 1/2	1 1/4-11 1/2	-	1 5/8-12	1 5/8-12	1 5/8-14	-	1 11/16-12
-24	1 1/2-11 1/2	1 1/2-11 1/2	-	1 7/8-12	1 7/8-12	1 7/8-14	-	2-12
-32	2-11 1/2	2-11 1/2	-	2 1/2-12	2 1/2-12	2 1/2-12	-	-
-40	2 1/2-8	2 1/2-8	-	3-12	3-12	-	-	-
-48	3-8	3-8	-	3 1/2-12	3 1/2-12	-	-	-

Through hole dimensions

All dimensions are nominal. In jump size bodies, the minimum through hole dimensions will correspond to the smallest dash size.

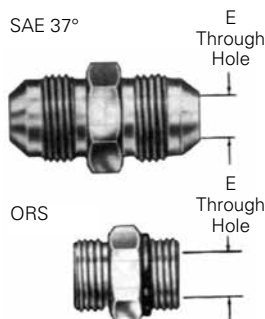

Dash size	E through hole			
	SAE 37°		ORS	
	mm	in	mm	in
-03	3,0	0.12	-	-
-04	4,3	0.17	4,3	0.17
-05	5,8	0.23	-	-
-06	7,6	0.30	6,6	0.26
-08	9,9	0.39	9,7	0.38
-10	12,2	0.48	12,2	0.48
-12	15,5	0.61	15,5	0.61
-16	21,3	0.84	20,6	0.81
-20	25,8	1.08	26,1	1.03
-24	33,3	1.31	32,0	1.26
-32	45,2	1.78	-	-

Steel adapters

Non-threaded connections, American connections

How to measure non-threaded connections

Four bolt flange

First measure the port hole diameter using the caliper. Next, measure the longest bolt hole spacing from center-to-center or measure the flange head diameter.

Staplok

Measure the male diameter with the O.D. portion of the caliper. Measure the female half by inserting the I.D. portion of the caliper into the through hole.

Dash numbers

Most fluid piping system sizes in the United States are measured by dash numbers. These are universally used abbreviations for the size of the component expressed as the numerator of the fraction

with the denominator always being 16. For example, a -04 port is 4/16 or 1/4-inch. Dash numbers are usually nominal (in name only) and are abbreviations that make ordering of components easier.

American connections

NPTF (National pipe tapered fuel)

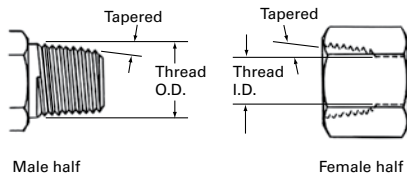

This connection is still widely used in fluid power systems, even though it is not recommended by the National Fluid Power Association (NFPA) for use in hydraulic

applications. The thread is tapered and the seal takes place by deformation of the threads.

NPTF threads

Measure thread diameter and subtract 1/4-inch to find the nominal pipe size.

Inch size	Dash size.	Nominal thread size	Male thread O.D. inch		Female thread I.D. inch	
			Fract.	Dec.	Fract.	Dec.
1/8	02	1/8-27	13/32	0.41	3/8	0.38
1/4	04	1/4-18	17/32	0.54	1/2	0.49
3/8	06	3/8-18	11/16	0.68	5/8	0.63
1/2	08	1/2-14	27/32	0.84	25/32	0.77
3/4	12	3/4-14	1 1/16	1.05	1	0.98
1	16	1-11 1/2	1 5/16	1.32	1 1/4	1.24
1 1/4	20	1 1/4-11 1/2	1 21/32	1.66	1 19/32	0.58
1 1/2	24	1 1/2-11 1/2	1 29/32	1.90	1 13/16	1.82
2	32	2-11 1/2	2 3/8	2.38	2 5/16	2.30

NPSM (National pipe straight mechanical)

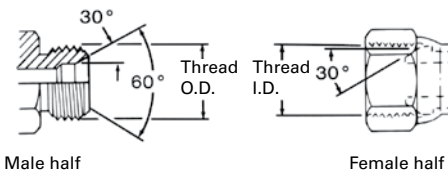

This connection is sometimes used in fluid power systems. The female half has a straight thread and an inverted 30° seat. The male half of the connection has a straight thread and a 30° internal chamfer. The seal takes place by compression of the 30°

seat on the chamfer. The threads hold the connection mechanically.

Note: A properly chamfered NPTF male will also seal with the NPSM female.

NPSM threads

Inch size	Dash size.	Nominal thread size	Male thread O.D. inch		Female thread I.D. inch	
			Fract.	Dec.	Fract.	Dec.
1/8	02	1/8-27	13/32	0.41	3/8	0.38
1/4	04	1/4-18	17/32	0.54	1/2	0.49
3/8	06	3/8-18	11/16	0.68	5/8	0.63
1/2	08	1/2-14	27/32	0.84	25/32	0.77
3/4	12	3/4-14	1 1/16	1.05	1	0.98
1	16	1-11 1/2	1 5/16	1.32	1 1/4	1.24
1 1/4	20	1 1/4-11 1/2	1 21/32	1.66	1 19/32	0.58
1 1/2	24	1 1/2-11 1/2	1 29/32	1.90	1 13/16	1.82
2	32	2-11 1/2	2 3/8	2.38	2 5/16	2.30

American connections

SAE J1926 straight thread O-Ring boss (ORB)

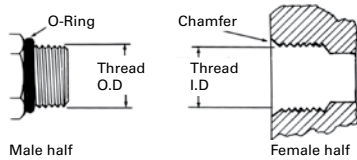

This port connection is recommended by the NFPA for optimum leakage control in medium and high pressure hydraulic systems. The male connector has a straight thread and an O-Ring. The female port has a straight

thread, a machined surface (minimum spotface) and a chamfer to accept the O-Ring. The seal takes place by compressing the O-Ring into the chamfer. The threads hold the connection mechanically.

Inch size	Dash size.	Nominal thread size	Male thread O.D. inch		Female thread I.D. inch	
			Fract.	Dec.	Fract.	Dec.
1/8	02	5/16-24	5/16	0.31	9/32	0.27
3/16	03	3/8-24	3/8	0.38	11/32	0.34
1/4	04	7/16-20	7/16	0.44	13/32	0.39
5/16	05	1/2-20	1/2	0.50	15/32	0.45
3/8	06	9/16-18	9/16	0.56	17/32	0.51
1/2	08	3/4-16	3/4	0.75	3/4	0.69
5/8	10	7/8-14	7/8	0.88	13/16	0.81
3/4	12	1 1/16-12	1 1/16	1.06	1	0.98
7/8	14	1 3/16-12	1 3/16	1.19	1 1/8	1.13
1	16	1 5/16-12	1 5/16	1.31	1 1/4	1.23
1 1/4	20	1 5/8-12	1 5/8	1.63	1 9/16	1.54
1 1/2	24	1 7/8-12	1 7/8	1.88	1 13/16	1.79
2	32	2 1/2-12	2 1/2	2.50	2 7/16	2.42

SAE 37° J514 hydraulic

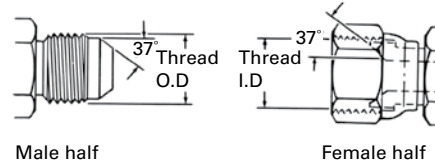

This connection is very common in fluid power systems. Both the male and female halves of the connections have SAE 37° seats. The seal takes place by establishing a line contact between the male flare and the female cone seat. The

threads hold the connection mechanically.

Caution: In the -02, -03, -04, -05, -08 and -10 sizes, the threads of the SAE 45° flare and the SAE 37° flare are the same. However, the sealing surface angles are not the same.

Inch size	Dash size.	Nominal thread size	Male thread O.D. inch		Female thread I.D. inch	
			Fract.	Dec.	Fract.	Dec.
1/8	02	5/16-24	5/16	0.31	9/32	0.27
3/16	03	3/8-24	3/8	0.38	11/32	0.34
1/4	04	7/16-20	7/16	0.44	13/32	0.39
5/16	05	1/2-20	1/2	0.50	15/32	0.45
3/8	06	9/16-18	9/16	0.56	17/32	0.51
1/2	08	3/4-16	3/4	0.75	3/4	0.69
5/8	10	7/8-14	7/8	0.88	13/16	0.81
3/4	12	1 1/16-12	1 1/16	1.06	1	0.98
7/8	14	1 3/16-12	1 3/16	1.19	1 1/8	1.13
1	16	1 5/16-12	1 5/16	1.31	1 1/4	1.23
1 1/4	20	1 5/8-12	1 5/8	1.63	1 9/16	1.54
1 1/2	24	1 7/8-12	1 7/8	1.88	1 13/16	1.79
2	32	2 1/2-12	2 1/2	2.50	2 7/16	2.42

ORS SAE J1453 O-Ring face seal

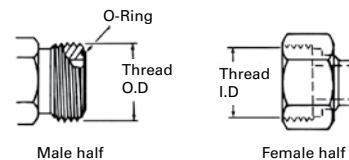

This connection offers the very best leakage control available today. The male connector has a straight thread and an O-Ring in the face. The female has a straight thread and a machined flat face.

The seal takes place by compressing the O-Ring onto the flat face of the female, similar to the split flange type fitting. The threads hold the connection mechanically.

Inch size	Dash size.	Nominal thread size	Male thread O.D. inch		Female thread I.D. inch	
			Fraction	Decimal	Fraction	Decimal
1/4	04	9/16-18	9/16	0.56	17/32	0.51
3/8	06	11/16-16	11/16	0.69	5/8	0.63
1/2	08	13/16-16	13/16	0.82	3/4	0.75
5/8	10	1-14	1	1.00	15/16	0.93
3/4	12	1 3/16-12	1 3/16	1.19	1 1/8	1.11
1	16	1 7/16-12	1 7/16	1.44	1 3/8	1.36
1 1/4	20	1 11/16-12	1 11/16	1.69	1 5/8	1.61
1 1/2	24	2-12	2	2.00	1 15/16	1.92

Steel adapters

American connections

American connections

SAE J512 inverted flare

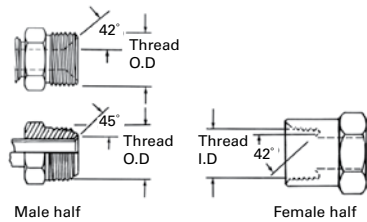

This connection is frequently used in automotive systems. The male connector can either be a 45° flare in the tube fitting form or a 42° seat in the machined adapter form.

The female has a straight thread with a 42° inverted flare. The seal takes place on the flared surfaces. The threads hold the connection mechanically.

Inch size	Dash size.	Nominal thread size	Male thread O.D. inch		Female thread I.D. inch	
			Fract.	Dec.	Fract.	Dec.
1/8	02	5/16-24	5/16	0.32	9/32	0.28
3/16	03	3/8-24	3/8	0.38	11/32	0.34
1/4	04	7/16-24	7/16	0.44	13/32	0.40
5/16	05	1/2-20	1/2	0.50	15/32	0.45
3/8	06	5/8-18	5/8	0.63	9/16	0.57
7/16	07	11/16-18	11/16	0.69	5/8	0.63
1/2	08	3/4-18	3/4	0.75	23/32	0.70
5/8	10	7/8-18	7/8	0.88	13/16	0.82
3/4	12	1 1/16-16	1 1/16	1.06	1	1.00

SAE J512 45°

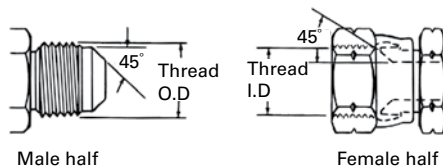

This connection is commonly used in refrigeration, automotive and truck piping systems. The connector is frequently made of brass. Both the male and female connectors have 45° seats. The seal takes place between the male flare the female cone seat.

The threads hold the connection mechanically.

Caution: In the -02, -03, -04, -05, -08 and -10 sizes, the threads of the SAE 45° flare and the SAE 37° flare are the same. However, the sealing surface angles are not the same.

Inch size	Dash size	Nominal thread size	Male thread O.D. inch		Female thread I.D. inch	
			Fract.	Dec.	Fract.	Dec.
1/8	02	5/16-24	5/16	0.31	9/32	0.27
3/16	03	3/8-24	3/8	0.38	11/32	0.34
1/4	04	7/16-20	7/16	0.44	13/32	0.39
5/16	05	1/2-20	1/2	0.50	15/32	0.45
3/8	06	5/8-18	5/8	0.63	9/16	0.57
1/2	08	3/4-16	3/4	0.75	11/16	0.69
5/8	10	7/8-14	7/8	0.88	13/16	0.81
3/4	12	1 1/16-14	1 1/16	1.06	1	0.99
7/8	14	1 1/4-12	1 1/4	1.25	1 5/32	1.16
1	16	1 3/8-12	1 3/8	1.38	1 9/32	1.29

Staplok (SAE J1467)

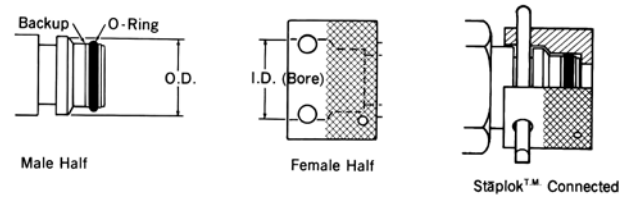

This is a radial O-Ring seal connection developed in Germany and commonly used for hydraulic application in underground mines. The male contains an exterior O-Ring and backup ring, plus a groove to accept the "staple". The female has a smooth bore

with two holes for the staple. A "U" shaped retaining clip or staple is inserted through the two holes, passing through the groove in the male to lock the connection together. The seal takes place by contact between the O-Ring in the male and the smooth bore of the female.

Inch size	Dash size.	Nominal thread size	Male thread O.D. inch		Female thread I.D. inch	
			Fraction	Decimal	Fraction	Decimal
1/4	04	-	9/32	0.586	1 9/32	0.597
3/8	06	-	25/32	0.783	51/64	0.794
1/2	08	-	15/16	0.940	61/64	0.951
3/4	12	-	1 9/64	1.137	1 9/64	1.148
1	16	-	1 17/32	1.529	1 35/64	1.540
1 1/4	20	-	1 13/16	1.806	1 13/16	1.817
1 1/2	24	-	2 5/32	2.163	2 11/64	2.174
2	32	-	2 33/64	2.517	2 17/32	2.528

American connections

How to measure 4-Bolt Flange

First measure the port hole diameter using the caliper. Next, measure the longest bolt hole spacing from center-to-center (Dimension "A") or measure the flanged head diameter.

SAE J518 Code 61/62 4-Bolt Flange*

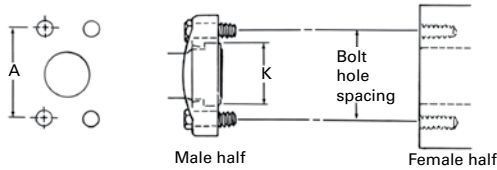

This connection is commonly used in fluid power systems. There are two pressure ratings. Code 61 is referred to as the "standard" series and Code 62 is the "6000 psi" series. The design concept for both series is the same, but the bolt hole spacing and flanged head diameters are larger for the higher pressure, Code 62 connection. The female (port) is an unthreaded hole with four bolt holes in a rectangular pattern around the port. The male consists of a flanged head, grooved

for an O-Ring, and either a captive flange or split flange halves with bolt holes to match the port. The seal takes place on the O-Ring, which is compressed between the flanged head and the flat surface surrounding the port. The threaded bolts hold the connection together.

* SAE J518, JIS B 8363, ISO/ DIS 6162 and DIN 20066 are interchangeable, except for bolt sizes.

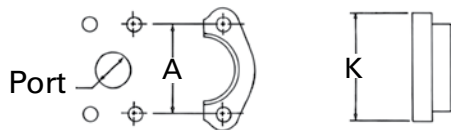

Inch Size (dash size)	Port hole I.D. inch fract. (dec.)	Bolt dimension inch		Bolt hole spacing "A" inch (dec.)		Flanged head dia. "K" inch (dec.)	
		Cd. 61	Cd. 62	Cd. 61	Cd. 62	Cd. 61	Cd. 62
1/2 (08)	1/2 (0.50)	5/16-18x1-1/4	5/16-18x1-1/4	1-1/2 (1.50)	1-19/32 (1.59)	1-3/16 (1.19)	1-1/4 (1.25)
3/4 (12)	3/4 (0.75)	3/8-16x1-1/4	3/8-16x1-1/2	1-7/8 (1.88)	2.00 (2.00)	1-1/2 (1.50)	1-5/8 (1.63)
1.00 (16)	1.00 (1.00)	3/8-16x1-1/4	7/16-14x1-3/4	2-1/16 (2.06)	2 1/4 (2.25)	1-3/4 (1.75)	1-7/8 (1.88)
1-1/4 (20)	1-1/4 (1.25)	7/16-14x1-1/2	1/2-13x1-3/4	2-5/16 (2.31)	2-5/8 (2.63)	2.00 (2.00)	2-1/8 (2.13)
1-1/2 (24)	1-1/2 (1.50)	1/2-13x1-1/2	5/8-11x2-1/4	2-3/4 (2.75)	3-1/8 (3.12)	2-3/8 (2.38)	2-1/2 (2.50)
2.00 (32)	2.00 (2.00)	1/2-13x1-1/2	3/4-10x2-3/4	3-1/16 (3.06)	3-13/16 (3.81)	2-13/16 (2.81)	3-1/8 (3.12)

ISO connections

ISO 6149 Port and Stud Ends with ISO 261 Threads and O-Ring Seal

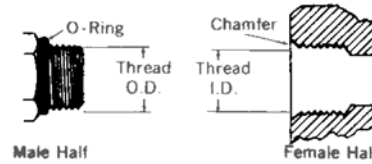

This port connection is similar to the SAE J514 Straight Thread O-Ring Boss (ORB). The major difference is that this connection uses metric threads. The male connector has a straight thread and an O-Ring. The female port has a straight thread, a machined

surface (minimum spotface) and a chamfer to accept the O-Ring. The seal takes place by compressing the O-Ring into the chamfer. The threads hold the connection mechanically.

Metric thread	Male thread O.D.	Female thread I.D.
	mm	mm
M8 x 1	8	7
M10 x 1	10	9
M12 x 1,5	12	10,5
M14 x 1,5*	14	12,5
M16 x 1,5	16	14,5
M18 x 1,5	18	16,5
M22 x 1,5	22	20,5
M27 x 2	27	25
M33 x 2	33	31
M42 x 2	42	40
M48 x 2	48	46
M60 x 2	60	58

* M14 x 1,5: Recommended for diagnostic port application.

Steel adapters

ISO connections

ISO connections

ISO/DIS 6162 4-Bolt Flange*

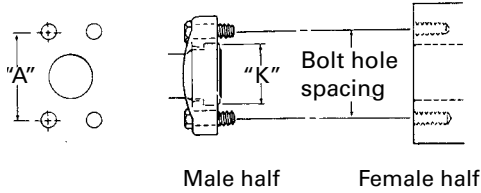

This connection is commonly used in fluid power systems. There are two pressure ratings. PN 35/350 bar (Code 61) is the "standard" series and PN 415 bar (Code 62) is the high pressure series. The design concept for both series is the same, but the bolt hole spacing and flanged head diameters are larger for the higher pressure, PN 415 bar connection. Both metric and inches bolts are used. The port will have an "M" stamped on it if metric bolts are required.

The female (port) is an unthreaded hole with four bolt holes in a rectangular pattern around the port. The male consists of a flanged head, grooved for an O-Ring, and either a captive flange or split flange halves with bolt holes to match the port. The seal takes place on the O-Ring, which is compressed between the flanged head and the flat surface surrounding the port. The threaded bolts hold the connection together.

* ISO/DIS 6162, DIN 20066, JIS B 8363 and SAE J518 are interchangeable, except for bolt sizes.

Inch size	Flanged head dia. "K"			
	ISO 6162-1 Bar (Cd.61)		ISO 6162-2 Bar (Cd.62)	
	mm	in	mm	in
1/2	30.18	1.19	31.75	1.25
3/4	38.10	1.50	41.28	1.63
1	44.45	1.75	47.63	1.88
1 1/4	50.80	2.00	53.98	2.13
1 1/2	60.33	2.38	63.50	2.50
2	71.42	2.81	79.38	3.13

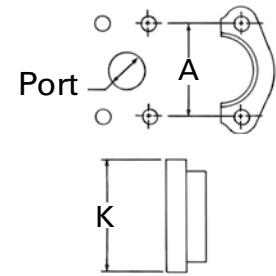

Size	Port hole	Bolt dimensions spacing		Bolt hole "A"	
		ISO 6162-1 Bar (Cd.61)	ISO 6162-2 Bar (Cd.62)	ISO 6162-1 Bar (Cd.61)	ISO 6162-2 Bar (Cd.62)
mm in (dash)	mm (in)	mm (in)	mm (in)	mm (in)	mm (in)
13(1/2) (08)	12,7 (.50)	M8 x 1.25x 30 (5/16-18 x 1 1/4)	M8 x 1.25 x 30 (5/16-18 x 1 1/4)	38.1 (1.50)	40.5 (1.57)
19(3/4) (12)	19,1 (.75)	M10 x 1.5 x 35 (3/8-16 x 1 1/4)	M10 x 1.5 x 40 (3/8-16 x 1 1/2)	47.6 (1.88)	50.8 (2.00)
25(1) (16)	25,4 (1.00)	M10 x 1.5 x 35 (3/8-16 x 1 1/4)	M12 x 1.75 x 45 (7/16-14 x 1 3/4)	52.4 (2.06)	57.2 (2.25)
32(1 1/4) (20)	31,8 (1.25)	M10 x 1.5 x 40 (7/16-14 x 1 1/2)	M14 x 2 x 50 (1/2-13 x 1 3/4)	58.7 (2.31)	66.7 (2.63)
38(1 1/2) (24)	38,1 (1.50)	M12 x 1.75 x 40 (1/2-13 x 1 1/2)	M16 x 2 x 55 (5/8-11 x 2 1/4)	69.9 (2.75)	79.4 (3.13)
51(2) (32)	50,8 (2.00)	M12 x 1.75 x 40 (1/2-13 x 1 1/2)	M20 x 2.5 x 70 (3/4-10 x 2 3/4)	77.8 (3.06)	96.8 (3.81)

BROWSE: Tools

Product Configurator +

Hose Assembly +

Cross Reference +

Crimp Specs +

German connections

Metric 30° (DIN 7631)

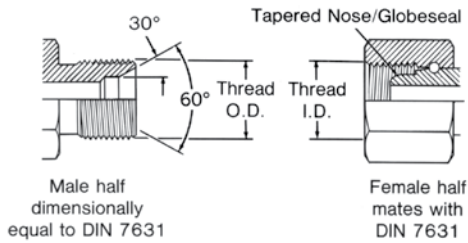

This connection is frequently used in hydraulic systems. The male has a straight metric thread and a 60° (included angle) recessed cone. The female has a straight thread and a tapered Nose/Globeseal

seat. The seal takes place by contact between the cone of the male and the nose of the tapered Nose/Globeseal flareless swivel.

The threads hold the connection mechanically.

Use with pipe/tube O.D.		Metric thread size	Male thread O.D.		Female thread I.D.	
mm	in		mm	in	mm	in
6	0.24	M12 x 1.5	12	0.47	10,5	0.41
8	0.32	M14 x 1.5	14	0.55	12,5	0.49
10	0.39	M16 x 1.5	16	0.63	14,5	0.57
12	0.47	M18 x 1.5	18	0.71	16,5	0.65
15	0.59	M22 x 1.5	22	0.87	20,5	0.81
18	0.71	M26 x 1.5	26	1.02	24,5	0.96
22	0.87	M30 x 1.5	30	1.18	28,5	1.12
28	1.10	M38 x 1.5	38	1.50	36,5	1.44
35	1.38	M45 x 1.5	45	1.77	43,5	1.71
42	1.65	M52 x 1.5	52	2.04	50,5	1.99

Metric 24° (DIN 3902)

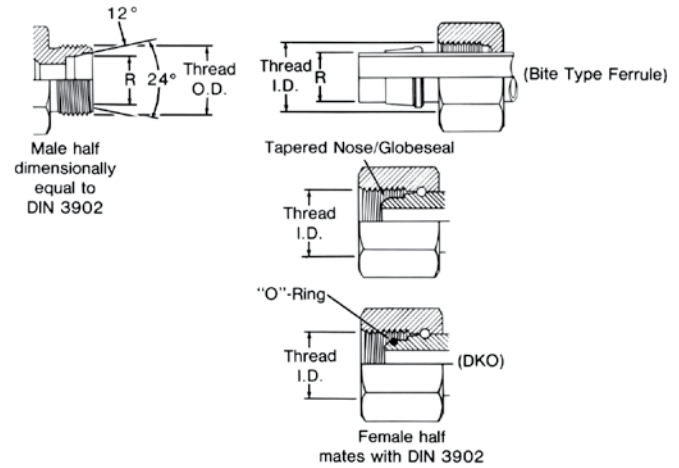

This connection style consists of a common male and three different female halves. The male has a straight metric thread, a 24° included angle and a recessed counterbore that matches the tube O.D. used with it. The female may

be a tube, nut and ferrule, a tapered nose/Globeseal flareless swivel or a tapered Nose/Globeseal flareless swivel with an O-Ring in the Nose (DKO type).

Tube O.D. "R" Dim. l.Rh.*		Tube O.D. "R" Dim. s.Rh.†		Metric thread Size	Male thread O.D.		Female thread I.D.	
mm	in.	mm	in		mm	in	mm	in
6	0.24	-	-	M12 x 1.5	12	0.47	10.5	0.41
8	0.32	6	0.24	M14 x 1.5	14	0.55	12.5	0.49
10	0.39	8	0.32	M16 x 1.5	16	0.63	14.5	0.57
12	0.47	10	0.39	M18 x 1.5	18	0.71	16.5	0.65
-	-	12	0.47	M20 x 1.5	20	0.78	18.5	0.73
15	0.59	14	0.55	M22 x 1.5	22	0.87	20.5	0.81
-	-	16	0.63	M24 x 1.5	24	0.94	22.5	0.89
18	0.71	-	-	M26 x 1.5	26	1.02	24.5	0.96
22	0.87	20	0.78	M30 x 2.0	30	1.18	28	1.11
28	1.10	25	0.98	M36 x 2.0	36	1.41	34	1.34
-	-	30	1.18	M42 x 2.0	42	1.65	40	1.57
35	1.38	-	-	M45 x 2.0	45	1.77	43	1.70
42	1.65	38	1.50	M52 x 2.0	52	2.04	50	1.97

*l.Rh. is a light duty system.

†s.Rh. is a heavy duty system.

Steel adapters

German connections

German connections

DIN 20066 4-bolt flange*

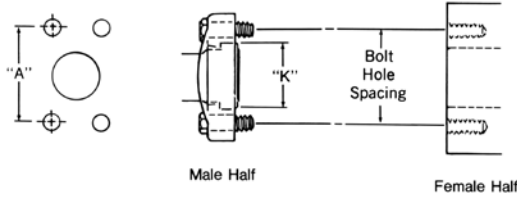

This connection is commonly used in fluid power systems. There are two pressure ratings. Form R (Code 61) is referred to as the “standard duty” series and Form S (Code 62) is the “heavy duty” series. The design concept for both series is the same, but the bolt hole spacing and flanged head diameters are larger for the higher pressure, Form S connection. Both metric and inch bolts are used. The female (port) is an unthreaded hole with four bolt holes in a rectangular pattern around the port. The male

consists of a flanged head, grooved for an O-Ring, and either a captive flange or split flange halves with bolt holes to match the port. The seal takes place on the O-Ring, which is compressed between the flanged head and the flat surface surrounding the port. The threaded bolts hold the connection together.

Note: *DIN 20066, IS/DIS 6166, JIS B 8363 and SAE J518 are interchangeable, except for bolt sizes.

Inch size	Flanged head dia. “K”			
	Form R (Cd. 61)		Form S (Cd. 62)	
	mm	in	mm	in
1/2	30.18	1.19	31.75	1.25
3/4	38.10	1.50	41.28	1.63
1	44.45	1.75	47.63	1.88
1 1/4	50.80	2.00	53.98	2.13
1 1/2	60.33	2.38	63.50	2.50
2	71.42	2.81	79.38	3.13

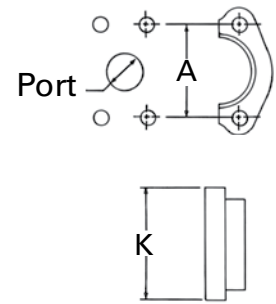

Size	Port hole	Bolt dimensions		Bolt hole spacing	
		Form R (Cd. 61)	Form S (Cd. 62)	Form R (Cd. 61)	Form S (Cd. 62)
				mm (in)	mm (in)
12 (1/2) (08)	12,7 (0.50)	M8 x 1.25 x 30 5/16–18 x 1 1/4	M8 x 1.25 x 30 5/16–18 x 1 1/4	38.10 (1.50)	40.49 (1.57)
20 (3/4) (12)	19,1 (0.75)	M10 x 1.5 x 30 3/8–16 x 1 1/4	M10 x 1.5 x 40 3/8–16 x 1 1/2	47.63 (1.88)	50.80 (2.00)
25 (1) (16)	25,4 (1.00)	M10 x 1.5 x 35 3/8–16 x 1 1/4	M12 x 1.75 x 45 7/16–14 x 1 3/4	52.37 (2.06)	57.15 (2.25)
32 (1-1/4) (20)	31,7 (1.25)	M10 x 1.75 x 40 7/16–14 x 1 1/2	M14 x 2 x 45 1/2–13 x 1 3/4	58.72 (2.31)	66.68 (2.63)
40 (1-1/2) (24)	38,0 (1.50)	M12 x 1.75 x 40 1/2–13 x 1 1/2	M16 x 2 x 55 5/8–11 x 2 1/4	69.85 (2.75)	79.38 (3.13)
50 (2) (32)	50,8 (2.00)	M12 x 1.75 x 40 1/2–13 x 1 1/2	M20 x 2.5 x 70 3/4–10 x 2 3/4	77.77 (3.06)	96.82 (3.81)

FIND IT QUICKLY

Want an easy way to find the new Eaton adapter part number?

Just go to **PowerSource Cross Reference** tool and type in the previous adapter part number here.

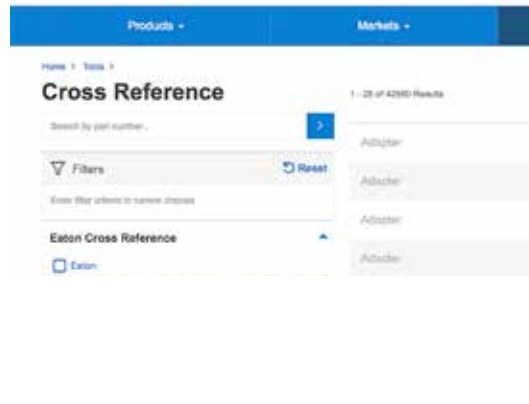

German connections

DIN 3852 Male connectors and female ports

Metric (DIN 3852) threads

Metric thread	Male thread O.D. "A"		Female thread I.D. "B"	
	mm	(in)	mm	(in)
M12 x 1.5	12	0.47	10,5	0.41
M14 x 1.5	14	0.55	12,5	0.49
M16 x 1.5	16	0.63	14,5	0.57
M18 x 1.5	18	0.71	16,5	0.65
M20 x 1.5	20	0.78	18,5	0.73
M22 x 1.5	22	0.87	20,5	0.81
M24 x 1.5	24	0.94	22,5	0.89
M26 x 1.5	26	1.02	24,5	0.96
M27 x 2	27	1.06	25	0.98
M30 x 1.5	30	1.18	28,5	1.12
M30 x 2	30	1.18	28	1.10
M33 x 2	33	1.30	31	1.22
M36 x 1.5	36	1.41	34,5	1.36
M36 x 2	36	1.41	34	1.33
M38 x 1.5	38	1.49	36,5	1.43
M38 x 2	38	1.49	36	1.41
M42 x 1.5	42	1.65	40,5	1.60
M42 x 2	42	1.65	40	1.57
M45 x 1.5	45	1.77	43,5	1.71
M45 x 2	45	1.77	43	1.69
M48 x 1.5	48	1.89	46,5	1.83
M48 x 2	48	1.89	46	1.81
M52 x 1.5	52	2.04	50,5	1.89
M52 x 2	52	2.04	50	1.97

For DIN 3852 Whitworth pipe thread dimensions, see BSPT/BSPP dimensions. They are the same.

How the seal works

This DIN is controlled by Germany, but other countries may use it as a reference for their connector and port designs. The chart below illustrates the various forms and how they seal.

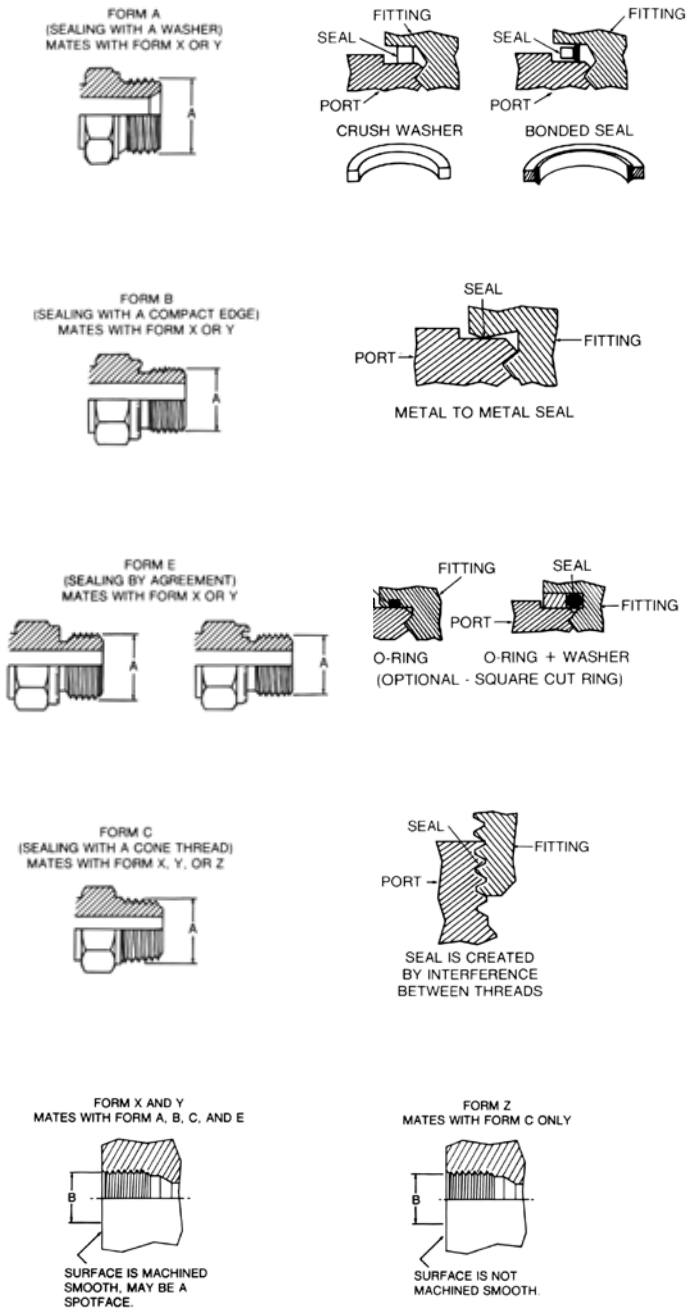

Steel adapters

French connections and British connections

French connections

Millimetric and GAZ series

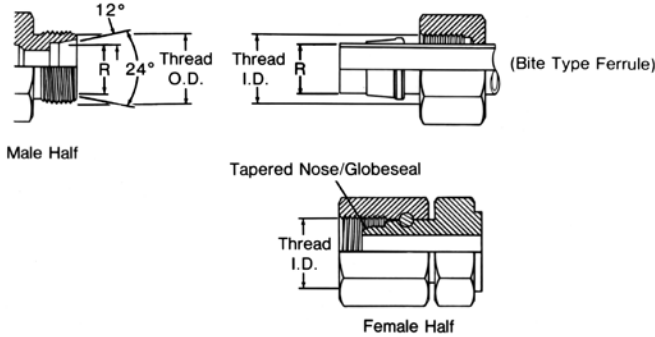

This connection consists of a common male and two different females. The millimetric series is used with

whole number metric O.D. tubing and the GAZ Series is used with fractional number metric O.D. pipe size tubing.

British connections

British standard pipe (BSP/BSPP/BSPT)

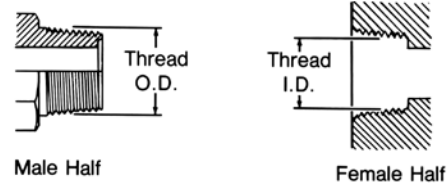

This BSPT (tapered) connection is similar to the NPT, except that the thread pitches are different in most sizes, and the thread

form and O.D.s are close but not the same. Sealing is accomplished by thread distortion. A thread sealant is recommended.

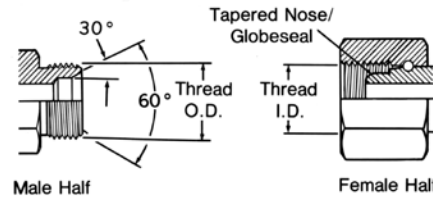

The BSP (parallel) male is similar to the NPSM male except the thread pitches are different in most sizes.

The female swivel BSPP has a tapered nose/Globeseal flareless swivel which seals on the cone seat of the male.

Millimetric and GAZ threads

Tubing O.D. "R" dim.		"Gaz" pipe O.D. "R" dim.		Metric thread	Male Thread O.D. "A"		Female Thread I.D. "B"	
mm	in	mm	in		mm	in	mm	in
6	0.24	-	-	M12 x 1.5	12	0.47	11	0.43
8	0.32	-	-	M14 x 1.5	14	0.55	12.5	0.49
10	0.39	-	-	M16 x 1.5	16	0.63	14.5	0.57
12	0.47	-	-	M18 x 1.5	18	0.71	16.5	0.65
14	0.55	13.25	0.52	M20 x 1.5	20	0.78	18.5	0.73
15	0.59	-	-	M22 x 1.5	22	0.87	20.5	0.81
16	0.63	16.75	0.66	M24 x 1.5	24	0.94	22.5	0.89
18	0.71	-	-	M27 x 1.5	27	1.06	25.5	1.00
22	0.87	21.25	0.83	M30 x 1.5	30	1.18	28.5	1.12
25	0.98	-	-	M33 x 1.5	33	1.30	31.5	1.24
28	1.10	26.75	1.05	M36 x 1.5	36	1.41	34.5	1.36
30	1.18	-	-	M39 x 1.5	39	1.54	37.5	1.48
32	1.25	-	-	M42 x 1.5	42	1.65	40.5	1.60
35	1.38	33.50	1.32	M45 x 1.5	45	1.77	43.5	1.71
38	1.50	-	-	M48 x 1.5	48	1.89	46.5	1.83
40	1.57	42.25	1.66	M52 x 1.5	52	2.04	50.5	1.99
45	1.77	-	-	M54 x 2.0	54	2.12	52	2.05
-	-	48.25	1.90	M58 x 2.0	58	2.28	55	2.16

BSPT/BSPP threads

Inch size	Dash size	Nominal thread size	Male thread O.D.		Female thread I.D.	
			fraction	decimal	fraction	decimal
1/8	02	1/8-28	3/8	0.38	11/32	0.35
1/4	04	1/4-19	33/64	0.52	15/32	0.47
3/8	06	3/8-19	21/32	0.65	19/32	0.60
1/2	08	1/2-14	13/16	0.82	3/4	0.75
5/8	10	5/8-14	7/8	0.88	13/16	0.80
3/4	12	3/4-14	1 1/32	1.04	31/32	0.97
1	16	1-11	1 5/16	1.30	1 7/32	1.22
1 1/4	20	1 1/4-11	1 21/32	1.65	1 9/16	1.56
1 1/2	24	1 1/2-11	1 7/8	1.88	1 25/32	1.79
2	32	2-11	2 11/32	2.35	2 1/4	2.26

*Frequently, the thread size is expressed as a fractional dimension preceded by the letter "G" or the letter "R". The "G" represents a parallel thread and the "R" indicates a tapered thread. For example, BSPP 3/8-19 may be expressed as G 3/8, and BSPT 3/8-19 may be expressed as R3/8.

Japanese connections

JIS 30° male inverted seat, parallel pipe threads

(Threads per JIS B 0202)

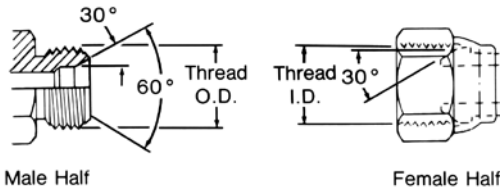

The JIS parallel is similar to the BSPP connection. The JIS parallel thread and

the BSPP connection are interchangeable.

Inch size	Dash size	Nominal thread size (similar to BSPP)	Male thread O.D.		Female thread O.D.	
			fract.	mm	fract.	mm
1/4	6 (04)	1/4-19	33/64	13.2	15/32	11.9
3/8	9 (06)	3/8-19	21/32	16.7	19/32	15.3
1/2	12 (08)	1/2-14	13/16	21.0	3/4	19.2
3/4	19 (12)	3/4-14	1 1/32	26.4	31/32	24.6
1	25 (16)	1-11	1 5/16	33.3	1 7/32	30.9
1 1/4	32 (20)	1 1/4-11	1 21/32	41.9	1 9/16	39.6
1 1/2	38 (24)	1 1/2-11	1 7/8	47.8	1 25/32	45.5
2	50 (32)	2-11	2 11/32	59.7	2 1/4	57.4

JIS 30° male inverted seat, parallel pipe threads

(Threads per JIS B 0207)

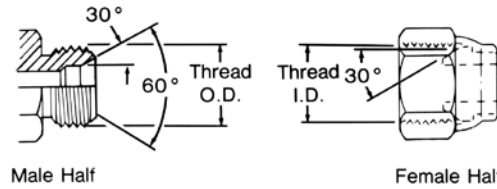

The JIS parallel (metric) is the same as the JIS parallel

(PF), except for the thread difference.

Inch size	Dash size equivalent	Thread size	Male thread O.D.		Female thread O.D.	
			mm	dec.	mm	dec.
6	04	M14 x 1.5	14	0.55	12.5	0.49
9	06	M18 x 1.5	18	0.71	16.5	0.65
12	08	M22 x 1.5	22	0.87	20.5	0.81
19	12	M30 x 1.5	30	1.18	28.5	1.12
25	16	M33 x 1.5	33	1.30	31.5	1.24
32	20	M42 x 1.5	42	1.65	40.5	1.60

JIS Tapered pipe (PT)

(Threads per JIS B 0203)

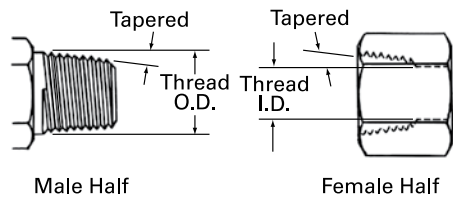

The JIS tapered thread is similar to the BSPT connection in design, appearance and dimensions.

The JIS tapered thread and the BSPT connection are interchangeable.

Inch size	Dash size	Nominal thread size (similar to BSPP)	Male thread O.D.		Female thread I.D.	
			fract.	mm.	fract.	mm
1/4	6 (04)	1/4-19	33/64	13.2	15/32	11.9
3/8	9 (06)	3/8-19	21/32	16.7	19/32	15.3
1/2	12 (08)	1/2-14	13/16	21.0	3/4	19.2
3/4	19 (12)	3/4-14	1 1/32	26.4	31/32	24.6
1	25 (16)	1-11	1 5/16	33.3	1 7/32	30.9
1 1/4	32 (20)	1 1/4-11	1 21/32	41.9	1 9/16	39.6
1 1/2	38 (24)	1 1/2-11	1 7/8	47.8	1 25/32	45.5
2	50 (32)	2-11	2 11/32	59.7	2 1/4	57.4

JIS 30° female (cone) seat, parallel pipe threads (PT)

(Threads per JIS B 0202)

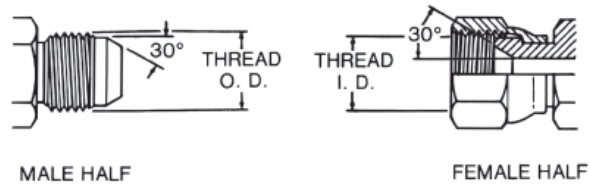

The Japanese JIS 30° flare is similar to the American SAE 37° flare connection in application as well as sealing

principles. However, the flare angle and dimensions are different. The threads are similar to BSPP.

Inch size	Dash size	Nominal thread size (similar to BSPP)	Male thread O.D.		Female thread O.D.	
			fract.	mm	fract.	mm
1/4	6 (04)	1/4-19	33/64	13.2	15/32	11.9
3/8	9 (06)	3/8-19	21/32	16.7	19/32	15.3
1/2	12 (08)	1/2-14	13/16	21.0	3/4	19.2
3/4	19 (12)	3/4-14	1 1/32	26.4	31/32	24.6
1	25 (16)	1-11	1 5/16	33.3	1 7/32	30.9
1 1/4	32 (20)	1 1/4-11	1 21/32	41.9	1 9/16	39.6
1 1/2	38 (24)	1 1/2-11	1 7/8	47.8	1 25/32	45.5
2	50 (32)	2-11	2 11/32	59.7	2 1/4	57.4

Steel adapters

Japanese connections

Japanese connections

JIS B 8363 4-bolt flange*

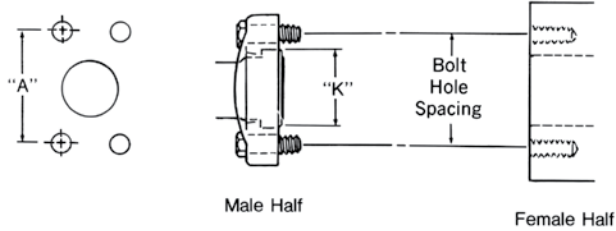

This connection is commonly used in fluid power systems. There are two pressure ratings. Type I (Code 61) is referred to as the “standard” series and Type II (Code 62) is the “6000 psi” series. The design concept for both series is the same, but the bolt hole spacing and flanged head diameters are larger for the higher pressure, Type II connection. Both metric and inch bolts are used. The female (port) is an unthreaded hole with four bolt holes in a rectangular pattern around the port. The male consists of a

flanged head, grooved for an O-Ring, and either a captive flange or split flange halves with bolt holes to match the port. The seal takes place on the O-Ring, which is compressed between the flanged head and the flat surface surrounding the port. The threaded bolts hold the connection together.

Note: *JIS B 8363, ISO/DIS 6162, DIN 20066, and SAE J518 are interchangeable, except for bolt sizes.

Size	Flanged head dia. “K”				
	Type I bar (Cd. 61)		Type II bar (Cd. 62)		
in	mm	in	mm	in	
1/2	30,18	1.19	31,75	1.25	
3/4	38,10	1.50	41,28	1.63	
1	44,45	1.75	47,63	1.88	
1 1/4	50,80	2.00	53,98	2.13	
1 1/2	60,33	2.38	63,50	2.50	
2	71,42	2.81	79,38	3.13	

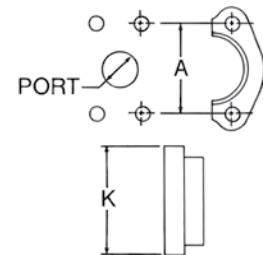

Size	Port hole	Bolt dimensions		Bolt hole spacing “A”	
		Type I (Cd. 61)	Type II (Cd. 62)	Type I (Cd. 61)	Type II (Cd. 62)
mm (in) (dash)	mm (in)	mm (in)	mm (in)	mm (in)	mm (in)
12 (1/2) (08)	12,7 (0.50)	M8 x 1.25 x 30 (5/16–18 x 1 1/4)	M8 x 1.25 x 30 (5/16–18 x 1 1/4)	38,1 (1.50)	40,49 (1.57)
19 (3/4) (12)	19,1 (0.75)	M10 x 1.5 x 30 (3/8–16 x 1 1/4)	M10 x 1.5 x 40 (3/8–16 x 1 1/2)	47,63 (1.88)	50,80 (2.00)
25 (1) (16)	25,4 (1.00)	M10 x 1.5 x 30 (3/8–16 x 1 1/4)	M12 x 1.75 x 45 (7/16–14 x 1 3/4)	52,37 (2.06)	57,15 (2.25)
32 (1 1/4) (20)	31,7 (1.25)	M10 x 1.5 x 40 (7/16–14 x 1 1/2)	M14 x 2 x 45 (1/2–13 x 1 3/4)	58,72 (2.31)	66,68 (2.63)
38 (1 1/2) (24)	38,0 (1.50)	M12 x 1.75 x 40 (1/2–13 x 1 1/2)	M16 x 2 x 55 (5/8–11 x 2 1/4)	69,85 (2.75)	79,38 (3.13)
50 (2) (32)	50,8 (2.00)	M12 x 1.75 x 40 (1/2–13 x 1 1/2)	M20 x 2.5 x 70 (3/4–10 x 2 3/4)	77,77 (3.06)	96,82 (3.81)

Tools

Cross Reference

Search by part number, part type and competitor

>

Filters Reset

Enter filter criteria to narrow choices

Eaton Cross Reference

Eaton

Recommendations may not be direct replacements. Please consult your recommendation. Update your results.

Competitor Cross Reference

Pauer Industries

Powertrack

Shaver

Sloan Transportation

Sinc Pneumatics

Ssp

Stratoflex

Swagelok

Synflex

Tompkins

Trident

Velvac

eatonpowersource.com

Japanese connections

JIS 210 Kg/cm² 4-bolt square flange

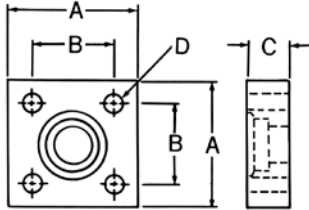

The JIS 4-bolt square flange connection is similar in concept to the SAE 4-bolt flange connection, except that

the JIS bolt pattern is square and the flange itself is different.

Size mm	Appx. inch size	Bolt size mm (bolt length for long design)	Dim. "A" mm (inch)	Dim. "B" mm (inch)	Dim. "C" mm (inch)	Bolt hole dia "D" mm (inch)
12	1/2	M10 x 1.5 x 55 (80)	63 (2.48)	40 (1.57)	22 (0.87)	11 (0.43)
19	3/4	M10 x 1.5 x 55 (80)	68 (2.67)	45 (1.77)	22 (0.87)	11 (0.43)
25	1	M12 x 1.75 x 70 (100)	80 (3.15)	53 (2.09)	28 (1.10)	13 (0.51)
32	1 1/4	M12 x 1.75 x 70 (100)	90 (3.54)	63 (2.48)	28 (1.10)	13 (0.51)
38	1 1/2	M16 x 2.0 x 90 (130)	100 (3.94)	70 (2.76)	36 (1.42)	18 (0.71)
50	2	M16 x 2.0 x 90 (130)	112 (4.41)	80 (3.15)	36 (1.42)	18 (0.71)

Komatsu 30° flare

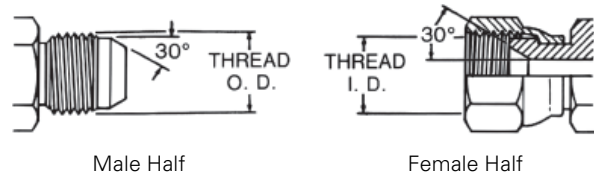

The Japanese Komatsu 30° flare is similar to the American SAE 37° flare connection in application as well as sealing

principles. However, the flare angle and dimensions are different. The threads are metric.

Komatsu Nominal size mm	Eaton equivalent	Komatsu Thread
02	04	M14 x 1.5
03	06	M18 x 1.5
04	08	M22 x 1.5
05	10	M24 x 1.5
06	12	M30 x 1.5
10	16	M33 x 1.5
12	20	M36 x 1.5
14	24	M42 x 1.5

JIS 210 Kg/cm² O-ring

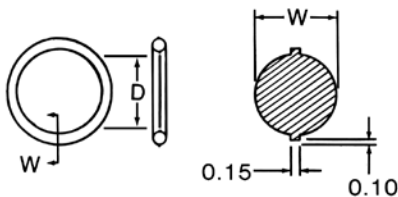

Nominal size mm	Dim. "D" mm	Dim. "W" mm
12	24.4 ± 0.15	3.1 ± 0.1
19	29.4 ± 0.15	3.1 ± 0.1
25	34.4 ± 0.15	3.1 ± 0.1
32	39.4 ± 0.15	3.1 ± 0.1
38	49.4 ± 0.15	3.1 ± 0.1
50	59.4 ± 0.15	3.1 ± 0.1

Steel adapters

Thread engagement nominal dimensions

Thread engagement

Dimensions may vary due to tolerance conditions.

Listed below are the thread engagement dimensions (B) which must be taken into consideration when making connection with ports or appropriate female adapters. The "B" dimension must be subtracted from the overall length (A) to insure proper connection.

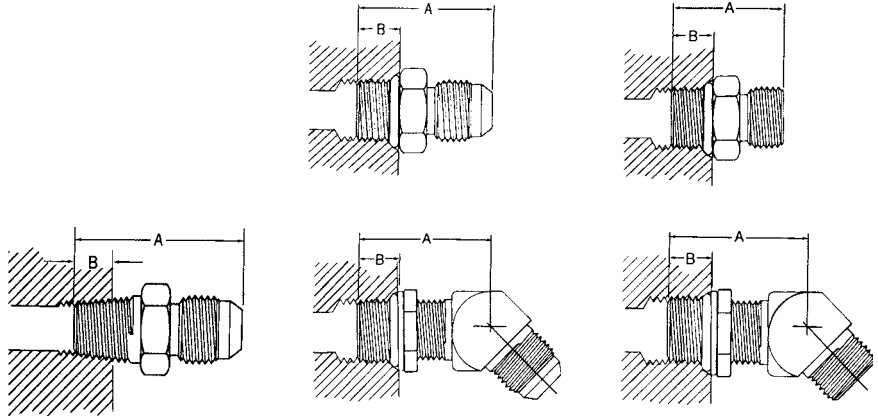

Dash size	Male pipe		SAE O-ring boss SAE J1926 with SAE 37° flare J514		SAE O-ring boss SAE J1926 with ORS J1453	
	Straight and angled dimension "B"		Straight and adjustable dimension "B"		Straight and adjustable dimension "B"	
	mm	in	mm	in	mm	in
-02	6,4	0.25	–	–	–	–
-04	9,7	0.38	9,1	0.36	10,9	0.43
-05	–	–	9,1	0.36	10,9	0.43
-06	9,7	0.38	9,1	0.39	11,9	0.47
-08	12,7	0.50	10,9	0.43	14,0	0.55
-10	–	–	12,7	0.50	16,0	0.63
-12	15,7	0.62	15,0	0.59	18,5	0.73
-14	–	–	15,0	0.59	–	–
-16	17,5	0.69	15,0	0.59	18,5	0.73
-20	17,5	0.69	15,0	0.59	18,5	0.73
-24	17,5	0.69	15,0	0.59	18,5	0.73
-32	19,1	0.75	15,0	0.59	–	–

Allowable bulkhead thickness

For ORS

Dash size	Hole diameter	ORS bulkhead thickness			
		Min		Max	
		mm	in	mm	in
-04	0.575 +.015/-.000	5,1	0.20	12,7	0.50
-06	0.700 +.015/-.000	5,1	0.20	15,0	0.59
-08	0.825 +.015/-.000	5,6	0.22	15,0	0.59
-10	1.015 +.015/-.000	5,8	0.23	15,0	0.59
-12	1.200 +.015/-.000	6,4	0.25	15,0	0.59
-16	1.450 +.015/-.000	6,4	0.25	15,2	0.60
-20	1.715 +.015/-.000	6,4	0.25	15,2	0.60
-24	2.030 +.015/-.000	6,4	0.25	15,2	0.60

For SAE 37° flare

Dash size	Hole diameter	SAE 37° bulkhead thickness straights				SAE 37° bulkhead thickness shapes			
		Min		Max		Min		Max	
		mm	in	mm	in	mm	in	mm	in
-03	0.391 +.016/-.000	1,3	0.05	10,4	0.41	3,3	0.13	6,4	0.25
-04	0.453 +.016/-.000	1,3	0.05	10,4	0.41	3,3	0.13	7,1	0.28
-05	0.516 +.016/-.000	1,3	0.05	10,4	0.41	3,3	0.13	7,1	0.28
-06	0.578 +.016/-.000	1,3	0.05	11,2	0.44	3,3	0.13	7,6	0.30
-08	0.766 +.016/-.000	1,3	0.05	11,2	0.44	4,1	0.16	8,6	0.34
-10	0.891 +.016/-.000	1,3	0.05	11,9	0.47	4,1	0.16	9,1	0.36
-12	1.076 +.016/-.000	1,3	0.05	11,9	0.47	4,1	0.16	9,7	0.38
-16	1.328 +.016/-.000	1,3	0.05	11,9	0.47	4,1	0.16	9,7	0.38
-20	1.656 +.031/-.000	1,3	0.05	11,9	0.47	4,1	0.16	9,7	0.38
-24	1.906 +.031/-.000	1,3	0.05	11,9	0.47	4,1	0.16	9,7	0.38

Metric thread dimensions

Conversion adapters

Sealing is achieved by means of an O-Ring, retaining washer and a properly machined port. The O-Ring is "captured" by the I.D. of the retaining washer. The port may be of the spot faced or a flat machined surface as long as the D6 dimension is met. Assembly instructions for adjustable type adapters are presented on page 26.

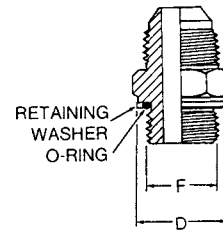
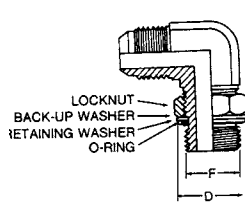

DIN 3852 large spot face

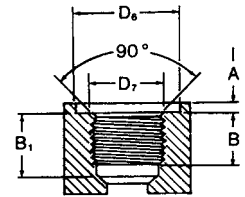

Equivalent to DIN 3852 form x

Thread size	M 10 x 1	M 12 x 1.5	M 14 x 1.5	M 16 x 1.5	M 18 x 1.5	M 20 x 1.5	M 22 x 1.5	M 26 x 1.5	M 27 x 2	M 33 x 2	M 42 x 2	M 48 x 2
F Thread Dia.	10.0	12.0	14.0	16.0	18.0	20.0	22.0	26.0	27.0	33.0	42.0	48.0
A max	1.0	1.5	1.5	1.5	2.0	2.0	2.5	2.5	2.5	2.5	2.5	2.5
B min (full thread)	12.0	12.0	12.0	12.0	12.0	14.0	14.0	16.0	16.0	18.0	20.0	22.0
B1 min	13.5	18.5	18.5	18.5	18.5	20.5	20.5	22.5	24.0	26.0	28.0	30.0
D max	15.7	18.7	19.7	23.2	26.2	28.2	30.2	35.2	36.2	43.2	52.7	58.7
D6 min	16.2	19.2	20.2	23.7	26.9	28.9	30.7	35.7	36.7	44.4	53.4	59.9
D7 max	10.2	12.2	14.2	16.2	18.2	20.2	22.2	26.2	27.2	33.3	42.3	48.3

BSPP (parallel) threads

Sealing is achieved by means of an O-Ring, retaining washer and a properly machined port.

The O-Ring is "captured" by the I.D. of the retaining washer. The compression is controlled by the thickness of the retaining washer.

The port may be of the spot faced or a flat machined surface as long as the D6 dimension is met.

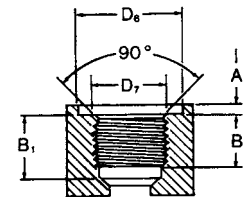
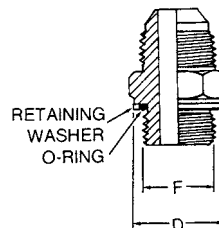
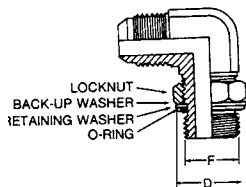

Thread size	G 1/8"-28		G 1/4"-19		G 3/8"-19		G 1/2"-14		G 3/4"-14		G 1"-11		G 1 1/4"-11		G 1 1/2"-11	
	mm	in	mm	in	mm	in	mm	in	mm	in	mm	in	mm	in	mm	in
F Thread Dia.	9,7	0.38	13,2	0.50	16,7	0.66	20,9	0.83	26,4	1.04	33,3	1.31	41,9	1.65	47,8	1.88
A max	1,0	0.04	2,0	0.08	2,05	0.10	2,5	0.10	2,5	0.10	2,5	0.10	2,5	0.10	2,5	0.10
B1 min (full thread)	8,0	0.31	12,0	0.47	12,0	0.47	14,0	0.63	16,0	0.63	18,0	0.71	20,0	0.79	22,0	0.87
B1 min	13,0	0.51	18,5	0.73	18,5	0.73	22,0	0.94	24,0	0.94	27,0	1.06	29,0	1.14	31,0	1.22
D max	15,7	0.62	19,7	0.78	24,0	0.94	28,7	1.38	35,2	1.38	43,2	1.70	52,7	2.07	58,7	2.31
D6 min	16,2	0.64	20,2	0.81	24,9	0.98	29,4	1.43	36,4	1.43	44,4	1.75	53,4	2.10	59,9	2.36
D7 max	10,0	0.39	13,4	0.53	16,9	0.67	21,2	1.05	26,7	1.05	33,6	1.32	42,3	1.67	48,2	1.90

BSPT (tapered) threads port sealing

Sealing is achieved by means of metal to metal deformation of the adapter and port threads.

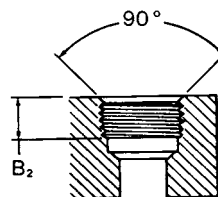

Thread size 11	R 1/8"-28		R 1/4"-19		R 3/8"-19		R 1/2"-14		R 3/4"-14		R 1"-11		R 1 1/4"-11		R 1 1/2"-11	
	mm	in	mm	in	mm	in	mm	in	mm	in	mm	in	mm	in	mm	in
B2 min (full thread)	5,5	0.22	8,5	0.33	8,5	0.33	10,5	0.41	13,0	0.51	14,5	0.57	17,0	0.67	17,0	0.67

Steel adapters

Hose fitting pressure charts

Pressure performance - Thread style

Eaton closely follows industry standards in design and in application recommendations. A key principle within ISO, SAE and other standards bodies is that the **maximum dynamic working pressure of the hose or adapter assembly** is the lesser of the hose and end connector(s) used.

The first table below provides excerpts from standard industry pressure rating charts for connector types as published by SAE (Society of Automotive Engineers).

Note: The tables below are applicable for low carbon free machining steels typically used in Fluid Power connections. For port type connections, the material and design of the port must be considered and may reduce expected strength.

For high pressure applications Eaton recommends the use of more robust connector designs such as Code 62 flange or O-Ring face seal.

Selected SAE pressure ratings

Dash size	Inch size	SAE 37°	Pipe SAE J476	Male ORB SAE J1926 ORS adapt.	Male ORB SAE J1926 non-ORS adapt.	Adjustable SAE J1926 ORS	Adjustable ORB non-ORS	ORS	Inverted flare	Code 61 Flange	Code 62 Flange
-2	1/8	5000	5000	-	5000	-	5000	-	5000	-	-
-3	3/16	5000	-	9000	5000	6000	5000	-	5000	-	-
-4	1/4	4500	5000	9000	5000	6000	4500	9000	4500	-	-
-5	5/16	4000	-	9000	5000	6000	4500	9000	4000	-	-
-6	3/8	4000	4000	9000	5000	6000	4000	9000	4000	-	-
-8	1/2	4000	3000	9000	4500	6000	4000	9000	4000	5000	6000
-10	5/8	3000	-	9000	3500	6000	3000	6000	3000	-	-
-12	3/4	3000	2500	6000	3500	6000	3000	6000	3000	5000	6000
-14	7/8	2500	-	6000	3000	6000	2500	6000	2500	-	-
-16	1	2500	2000	6000	3000	5000	2500	6000	2500	5000	6000
-20	1 1/4	2000	1150	4000	2500	4000	2000	3600	2000	4000	6000
-24	1 1/2	1500	1000	4000	2500	3000	2000	3600	1500	3000	6000
-32	2	1125	1000	3000	2000	2500	1500	3000	1125	3000	6000

International pressure rating charts

Maximum working pressure (PSI)

Hose fitting connection	Hose fitting size									
	-04	-05	-06	-08	-10	-12	-16	-20	-24	-32
Male British Pipe (BSP)	5000	-	4000	4000	3500	4000	3500	2500	2,000	2000
Female British Pipe (BSP)	5000	-	4000	4000	3500	4000	3500	2500	2,000	2000
Female Pipe (JIS)	5000	-	5000	5000	-	4000	4000	-	-	-

Maximum working pressure (PSI)

Hose fitting Connection	Hose fitting size									
	-06	-08	-10	-12	-15	-18	-22	-28	-35	-42
DIN light	3625	3625	3625	3625	3625	2325	2325	1450	1450	1450

Pressure performance - All Eaton Components

With higher pressures it is critical to know the construction materials and manufacturing method to ensure performance. When all components in a system are

Eaton supplied, for example an Eaton hose fitting is mated with an Eaton adapter or tube fitting, the combination may be used at higher pressures with confidence.

These higher ratings are noted in the chart below.

Maximum dynamic working pressure of the hose or adapter assembly is the lesser of the hose and end connector(s) used.

All Eaton pressure ratings¹

Dash Size	Inch Size	SAE 37° Male	SAE 37° Female	Male NPTF	Female NPTF	Male ORB/ORS	Male ORB/Non-ORS	Adj. ORB/ORS	Adj. ORB/non-ORS	ORS	Flareless Ermeto	Code 61	Code 62	STC
-2	1/8	-	-	10,000	6,000	-	5,000	-	5,000	-	5,000	-	-	-
-3	3/16	-	-	-	-	9,000	5,000	6,000	5,000	-	5,000	-	-	-
-4	1/4	8,500	7,500	9,500	6,000	9,000	5,000	6,000	4,500	9,000	4,500	-	-	-
-5	5/16	9,000	9,000	-	-	9,000	5,000	6,000	4,500	-	4,000	-	-	-
-6	3/8	8,500	8,500	8,000	6,000	9,000	5,000	6,000	4,000	9,000	4,000	-	-	5,000
-8	1/2	6,000	5,000	6,000	5,000	9,000	4,500	6,000	4,000	9,000	4,000	5,000	6,000	4,250
-10	5/8	5,500	5,000	-	-	9,000	3,500	6,000	3,000	9,000	3,000	-	-	4,000
-12	3/4	5,500	5,000	5,500	5,500	6,000	3,500	6,000	3,000	6,000	3,000	5,000	6,000	4,000
-14	7/8	5,000	5,500	-	-	6,000	3,000	6,000	2,500	-	2,500	-	-	-
-16	1	5,000	5,000	4,500	3,000	6,000	3,000	5,000	2,500	6,000	2,500	5,000	6,000	4,000
-20	1-1/2	5,000	3,600	3,000	2,500	4,000	2,500	4,000	2,000	4,500	2,000	4,000	6,000	-
-24	1-1/4	3,000	3,000	3,000	3,000	4,000	2,500	3,000	2,000	4,000	1,500	3,000	6,000	-
-32	2	2,000	1,750	2,000	1,500	3,000	2,000	2,500	1,500	3,000	1,125	3,000	6,000	-

¹ It is recommended to use an adapter or connector with an elastomeric seal when encountering peak pressure or dynamic applications.

Dynamic operating pressure

Dynamic operating conditions refers to cyclic pressure impulses, usually considered to be from near zero to the highest system pressure. Hydraulic standards typically represent these as square waves and expect a component to handle on the order of 200,000 to well over one million such cycles with a burst: operating safety factor of 4:1. The above charts are created with dynamic applications in mind. Most industrial and mobile hydraulic systems fit the dynamic operating pressure profile, for example hydraulic work circuits on construction equipment or on injection molding equipment.

Static operating pressure

Static operating conditions typically range from zero to operating pressure, but with far fewer cycles expected for the system life – perhaps 30,000 to 50,000 cycles and sharp pressure spikes are not expected, allowing a burst: operating safety factor of 3:1 or less. For static operating conditions, the Eaton ratings above can be safely increased by 25-30%. For example, a 3000 psi dynamic rated hose might be used in a 4000 psi static pressure application. Typical examples of static applications are water blast and hydraulic jacking.

Materials

The above tables represent performance using common low carbon steel material. Other materials and their

characteristics influence these ratings. Medium carbon steels or heat treated materials can support higher working pressures. Conversely non-ferrous materials such as aluminum or brass will have reduced capability – as much as 50%, or less, pressure handling capability. It is important to consider material properties in designing a system to ensure pressure rating compatibility of all materials.

Design & application

Eaton's Fluid Conveyance engineering and support teams have many decades of experience in designing, manufacturing and servicing hydraulic and other fluid conveyance systems globally. Eaton's product line is designed as a comprehensive collection of hose, fittings,

connectors, couplings and accessories that allow a system designer to select components to complete a fluid power system or a service technician to replace a component with confidence. The individual product specifications, the above pressure ratings and other technical information are intended as supporting guidelines for system design and service needs and are not to be construed as a guarantee of performance of the system or of individual Eaton components. Eaton provides comprehensive technical support so please call with questions about pressure needs not covered by these charts or for specific application support.

Steel adapters

Maximum operating pressure

Hydraulic tubing—Maximum operating pressures

SAEJ356, J524, J525, J526, J527

Tube O.D.	Dash size	Tubing wall thickness (in inches)											
		0.028		0.035		0.049		0.065		0.083		0.095	
-	-	bar	psi	bar	psi	bar	psi	bar	psi	bar	psi	bar	psi
0.19	-03	297,0	4250	375,0	5450	-	-	-	-	-	-	-	-
0.25	-04	213,0	3100	272,0	3950	396,0	5750	420,0	6000	-	-	-	-
0.31	-05	169,0	2450	213,0	3100	315,0	4500	420,0	6000	-	-	-	-
0.38	-06	140,0	2000	175,0	2550	251,0	3650	350,0	5000	420,0	6000	420,0	6000
0.50	-08	-	-	127,0	1850	186,0	2700	251,0	3650	335,0	4800	388,0	5550
0.62	-10	-	-	105,0	1500	145,0	2100	196,0	2850	258,0	3750	299,0	4350
0.75	-12	-	-	84,0	1200	122,0	1750	162,0	2350	210,0	3050	248,0	3550
1.00	-16	-	-	62,0	900	89,0	1300	122,0	1750	157,0	2250	182,0	2600
1.25	-20	-	-	-	-	70,0	1000	93,0	1350	122,0	1750	143,0	2050
1.50	-24	-	-	-	-	-	-	79,0	1150	100,0	1450	119,0	1700
2.00	-32	-	-	-	-	-	-	58,0	850	77,0	1100	87,0	1250

Tube O.D.	Dash size	Tubing wall thickness (in inches)											
		0.109		0.120		0.134		0.148		0.156		0.188	
-	-	bar	psi	bar	psi	bar	psi	bar	psi	bar	psi	bar	psi
0.19	-03	-	-	-	-	-	-	-	-	-	-	-	-
0.25	-04	-	-	-	-	-	-	-	-	-	-	-	-
0.31	-05	-	-	-	-	-	-	-	-	-	-	-	-
0.38	-06	-	-	-	-	-	-	-	-	-	-	-	-
0.50	-08	420,0	6000	420,0	6000	-	-	-	-	-	-	-	-
0.62	-10	353,0	5050	392,0	5600	-	-	-	-	-	-	-	-
0.75	-12	286,0	4150	322,0	4600	-	-	-	-	-	-	-	-
1.00	-16	210,0	3000	231,0	3350	262,0	3800	294,0	4200	-	-	-	-
1.25	-20	162,0	2350	182,0	2650	189,0	2700	203,0	2950	217,0	3100	259,0	3750
1.50	-24	134,0	1950	148,0	2150	171,0	2450	171,0	2450	182,0	2600	220,0	3150
2.00	-32	100,0	1450	112,0	1600	126,0	1800	140,0	2000	147,0	2100	178,0	2550

Maximum operating pressure ratings at specified wall thickness are based upon recommended tubing ratings per SAEJ1065 as well as

limited laboratory test data. Operating pressures are based upon a 4:1 safety factor relative to tube burst data. Eaton recommends a

maximum operating pressure of the joint which is the lesser of the tubing rating or the mating connector rating.

Recommended wall thickness for tube fitting applications

Tube	Dash	Versil-Flare SAE 37° flare	Versil-Flare SAE 37° flareless	ORS-BR ORB	ORS-TF
0.19	-03	0.028 - 0.035	0.028 - 0.035	-	-
0.25	-04	0.028 - 0.065	0.028 - 0.065	0.028 - 0.065	0.028 - 0.065
0.31	-05	0.028 - 0.065	0.028 - 0.065	-	-
0.38	-06	0.028 - 0.065	0.028 - 0.095	0.035 - 0.083	0.028 - 0.065
0.50	-08	0.035 - 0.083	0.035 - 0.120	0.035 - 0.109	0.035 - 0.120
0.62	-10	0.035 - 0.095	0.035 - 0.120	0.035 - 0.120	0.035 - 0.095
0.75	-12	0.035 - 0.109	0.035 - 0.120	0.035 - 0.120	0.049 - 0.120
1.00	-16	0.035 - 0.120	0.035 - 0.134	0.049 - 0.148	0.049 - 0.134
1.25	-20	0.049 - 0.120	0.049 - 0.188	0.049 - 0.188	0.049 - 0.156
1.50	-24	0.065 - 0.120	0.065 - 0.188	0.065 - 0.188	0.065 - 0.188
2.00	-32	0.065 - 0.134	0.065 - 0.188	-	-

Recommended hydraulic tubing material specifications

Hydraulic tubing SAE specifications

Versil-Flare SAE 37° flared	Versil-Flare SAE 37° flareless	ORS-BR ORS	ORS-TF ORS
SAEJ524	SAEJ356	SAEJ356	SAEJ356
SAEJ525	SAEJ524	SAEJ524	SAEJ524
-	SAEJ525	SAEJ525	SAEJ525
-	SAEJ527	SAEJ526	SAEJ526

Hydraulic tubing material description

SAEJ356 electric resistance welded flash controlled low carbon steel, SAEJ524 seamless annealed low carbon steel, SAEJ525 electric resistance welded

cold worked annealed, SAEJ526 single wall welded low carbon steel (automotive), SAEJ527 brazed double wall low carbon steel (automotive). The maximum hardness of the above tubing should not exceed Rockwell B65.



Steel adapters

Assembly torque

Recommended parallel connection assembly torque

Eaton recommends that a torque wrench be used to assure proper fitting assembly of these connections.

The values listed are for steel connections.
Contact Eaton for torque values for other materials.

ORB low pressure with SAE 37° (SAE J1926-3)

Dash size	Thread size (inches)	Jam nut or straight fitting torque lb.-ft.	Jam nut or straight fitting torque newton meters
-03	3/8-24	8-9	12-13
-04	7/16-20	13-15	18-20
-05	1/2-20	14-15	19-21
-06	9/16-18	23-24	32-33
-08	3/4-16	40-43	55-57
-10	7/8-14	43-48	59-64
-12	1 1/16-12	68-75	93-101
-14	1 3/16-12	83-90	113-122
-16	1 5/16-12	112-123	152-166
-20	1 5/8-12	146-161	198-218
-24	1 7/8-12	154-170	209-230
-32	2 1/2-12	218-240	296-325

ORB high pressure with ORS (SAE J1926-2)

Dash size	Thread size (inches)	Jam nut or straight fitting torque lb.-ft.	Jam nut or straight fitting torque newton meters
-03	3/8-24	8-10	11-13
-04	7/16-20	14-16	20-22
-05	1/2-20	18-20	24-27
-06	9/16-18	24-26	33-35
-08	3/4-16	50-60	68-78
-10	7/8-14	72-80	98-110
-12	1 1/16-12	125-135	170-183
-14	1 3/16-12	160-180	215-245
-16	1 5/16-12	200-220	270-300
-20	1 5/8-12	210-280	285-380
-24	1 7/8-12	270-360	370-490

ORS (SAE J1453)

Dash size	Thread size (inches)	Swivel nut torque lb.-ft.	Swivel nut torque newton meters
-04	9/16-18	10-12	14-16
-06	11/16-16	18-20	24-27
-08	13/16-16	32-35	43-47
-10	1-14	46-50	62-68
-12	1 3/16-12	65-70	88-95
-16	1 7/16-12	92-100	125-136
-20	1 11/16-12	125-140	170-190
-24	2-12	150-165	204-224

SAE 37° (SAE J514)

Dash size	Thread size (inches)	Swivel nut torque lb.-ft.	Swivel nut torque newton meters
-04	7/16-20	11-12	15-16
-05	1/2-20	15-16	20-22
-06	9/16-18	18-20	24-28
-08	3/4-16	38-42	52-58
-10	7/8-14	57-62	77-85
-12	1 1/16-12	79-87	108-119
-16	1 5/16-12	108-113	148-154
-20	1 5/8-12	127-133	173-182
-24	1 7/8-12	158-167	216-227
-32	2 1/2-12	245-258	334-352

Recommended parallel connection assembly torque

Eaton recommends that a torque wrench be used to assure proper fitting assembly of these connections.

The values listed are for steel connections.
Contact Eaton for torque values for other materials.

Metric ISO 6149 (ISO 6149-2)

Thread size	Straight adapter or locknut torque	
	lb.-ft.	Newton meters
M10 x 1	13-15	18-20
M12 x 1.5	15-19	20-25
M14 x 1.5	19-23	25-30
M16 x 1.5	33-40	45-55
M18 x 1.5	37-44	50-60
M20 x 1.5	52-66	70-90
M22 x 1.5	55-70	75-95
M26 x 1.5	81-96	110-130
M27 x 2	96-111	130-150
M33 x 2	162-184	220-250
M42 x 2	170-192	230-260
M48 x 2	258-347	350-470

BSPP (ISO 1179-3)

Nominal thread size	Straight adapter or locknut torque	
	lb.-ft.	Newton meters
G 1/8-28	13-15	18-20
G 1/4-19	19-23	25-30
G 3/8-19	33-40	45-55
G 1/2-14	55-70	75-95
G 3/4-14	103-118	140-160
G 1-11	162-184	220-250
G 1 1/4-11	170-192	230-260
G 1 1/2-11	258-347	350-470

***"G" denotes parallel threads, other than ISO 6149. (Port connection only)

DKO Light Duty (ISO 8434-1 L)

DN size	Tube O.D.	Thread	DKO Light Duty (L)		
			Swivel Nut Hex Size	Swivel Nut Torque	Swivel Nut Torque
			ISO 8434-1	lb-ft 10%	Nm +10%
5	6	M12x1,5	14	15	20
6	8	M14x1,5	17	18	25
8	10	M16x1,5	19	33	45
10	12	M18x1,5	22	37	50
12	15	M22x1,5	27	44	60
16	18	M26x1,5	32	52	70
20	22	M30x2	36	96	130
25	28	M36x2	41	133	180
32	35	M45x2	50	221	300
40	42	M52x2	60	236	320

DKO Heavy Duty (ISO 8434-1 S)

DN size	Tube O.D.	Thread	DKO Heavy Duty (S)		
			Swivel Nut Hex Size	Swivel Nut Torque	Swivel Nut Torque
			ISO 8434-1	lb-ft +10%	Nm +10%
	6	M14x1,5	17	15	20
5	8	M16x1,5	19	26	35
6	10	M18x1,5	22	37	50
8	12	M20x1,5	24	48	65
10	14	M22x1,5	27	52	70
12	16	M24x1,5	30	63	85
16	20	M30x2	36	100	135
20	25	M36x2	41 (46)	125	170
25	30	M42x2	50	207	280
32	38	M52x2	60	236	320

Steel adapters

Assembly instructions

ORS tube fittings, pipe threads and SAE 37° tube fittings

Assembly instruction for ORS Tube Fittings

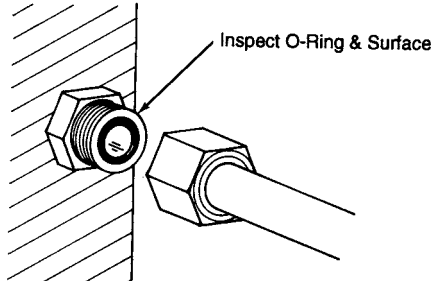

1. Inspect sealing surfaces and O-Ring groove for damage or foreign material. Check the O-Ring to insure that it is properly seated in the O-Ring groove.

Align fittings

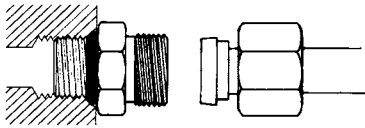

Hand tighten

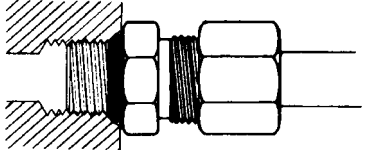

2. Lubricate threads with heavy lubricant (such as part number 222070 Lube).
3. Align the ORS Tube Fitting to the flat sealing connections and tighten the nut by hand. The nut should tighten easily by hand if properly aligned.

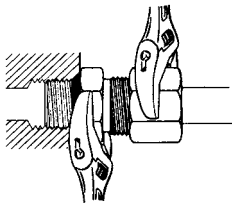

4. Complete the assembly by wrench tightening the nut to the recommended torque value on page 22.

Assembly instructions for Pipe Threads

1. Assemble connection hand tight.

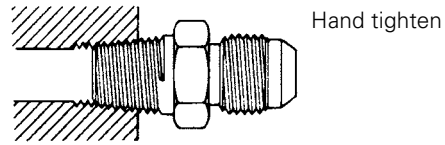

2. Mark male and female.

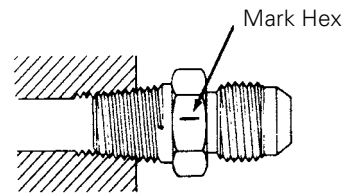

3. Rotate male; 1-1/2 turns if using thread sealant. 2 turns if not using thread sealant.

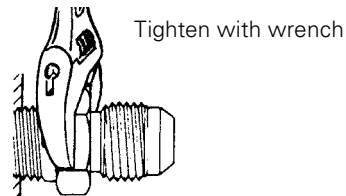

ORS tube fittings, pipe threads and SAE 37° tube fittings

continued

Assembly instructions for standard SAE 37° flare type tube fitting

Use SAE J524 or SAE J525 tubing for best bending and flaring results.

1. Cut the tubing with a tube cutter. If a fine tooth hacksaw is used, make sure cut-off is square; remove burrs with deburring tool, emery paper or fine file. Clean all dirt and grit from the I.D. and O.D. of the tube.
2. Place the nut and then the sleeve onto tube. The threaded end of nut and flared end of sleeve must face the end of tube.

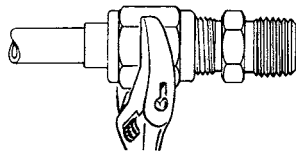
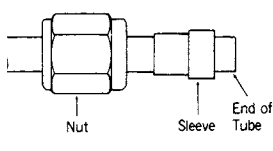

3. Flare the tube end with a flaring tool to provide a SAE 37° flare. Check the flare for correct diameter, excessive thin out and burrs or cracks.
4. Lubricate all mating surfaces of nut, ferrule and body with a heavy lubricant such as 222070 Lube.
5. Assemble the nut and sleeve to body. Turn the nut hand tight then wrench tighten for a leakproof joint. See page 22, torque values, for assembly using a torque wrench.

The Eaton standard SAE 37° flare fitting is easy to disassemble and may be reassembled repeatedly.

Cutting

To insure a leak-proof joint, the tubing should be cut square ($\pm 1^\circ$). A tube cutter is preferred, but a hacksaw or abrasive wheel can be used.



Out of Square Cut



Square Cut

Deburring

All cut tubes should be deburred. However, deburring is even more important if the tubing was cut with a hacksaw or abrasive wheel. Remove any burrs, both internally and externally, with a deburring tool, emery paper or fine file.

Clean the tube before assembly. Clean all dirt and grit from the I.D. and O.D. of the tube.

Assembly instructions for Versil-Flare tube fitting

Tubing cut-off

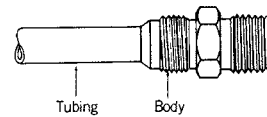

1. Tube should be cut to fit tight against the face of standard SAE 37° flare body.

Initial assembly

1. Deburr the end internally and externally. Clean all dirt and grit from I.D. and O.D.
2. Slide the nut and then the ferrule into the tube. Make sure the tapered end of ferrule points toward the nut.

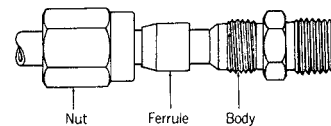

3. Lubricate all mating surfaces of nut, ferrule and body with a heavy lubricant such as 222070 Lube.
4. Place end of tube against standard SAE 37° flare body.
5. Slide the ferrule and nut against body and tighten the nut onto the body "Hand Tight." Mark the nut in relation to the body for location.

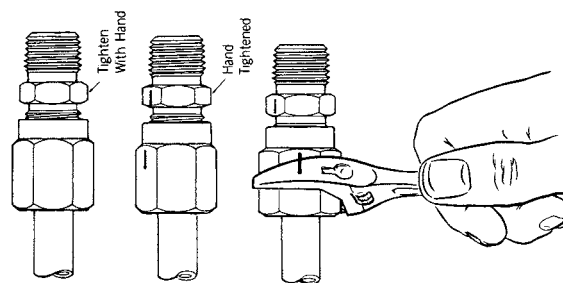

6. Hold tube against body and tighten nut a total of 1-1/4 turns on -3 through -10 and 1-1/2 turns -12 through -32.

Reassembly

1. Slide nut against the body and tighten to "Hand tight." Mark the nut for location.
2. Tighten nut a minimum of one "Hex" flat. The Versil-Flare flareless tube fitting is designed for a maximum of 10 reassemblies.

Steel adapters

Assembly instructions

Adjustable SAE O-Ring boss assembly instructions

On SAE, and BSPP threads without retaining washer

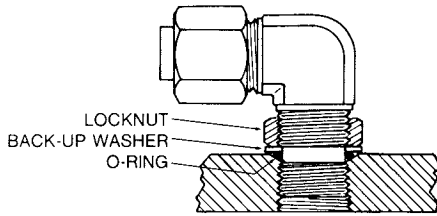

On BSPP threads with check washer

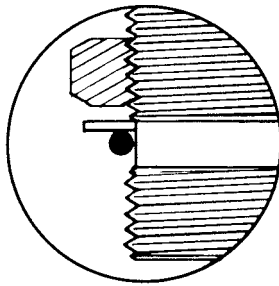
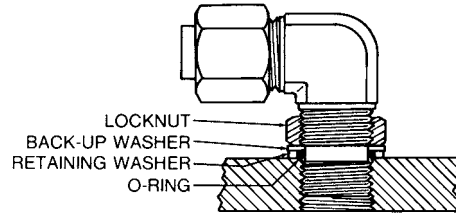

The O-Ring and back-up washer should be in the proper position on non-threaded section nearest to locknut. Lubrication of the O-Ring is recommended.

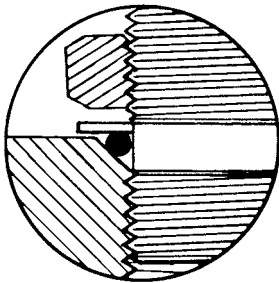
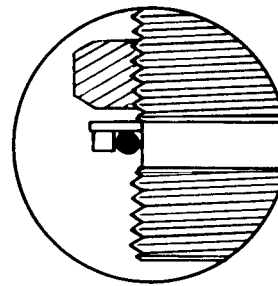

Tighten the fitting by hand into the straight threaded boss until back-up washer contacts face of boss (left) or retaining washer when thread is BSPP (right.)

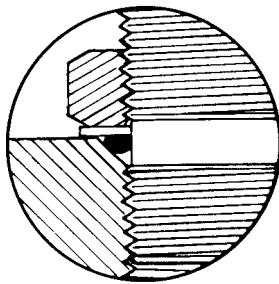
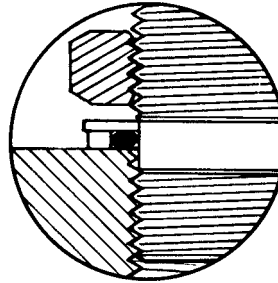

In order to position the fitting, unscrew up to one full turn then hold fitting in desired position and tighten locknut so that the back-up washer contacts face of boss and forces the O-Ring within boss cavity. With BSPP threads use same procedure. The difference between the two thread types exist in the retaining washer being in contact with face of boss (right inset). Assemble to the respective assembly torque specified on page 22.

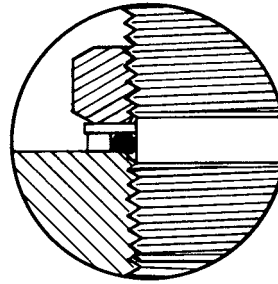

How to read adapter part numbers

Adapter part numbers

Adapter part numbers consist of a base number followed by a size designation. If the part number contains a "T" character between the base number and size designator, the first size designator signifies the tube size.

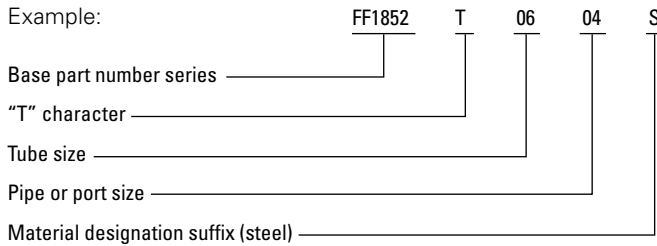

If the part number does not contain a "T" character between the base number and the size description, the first size designation signifies the pipe size.

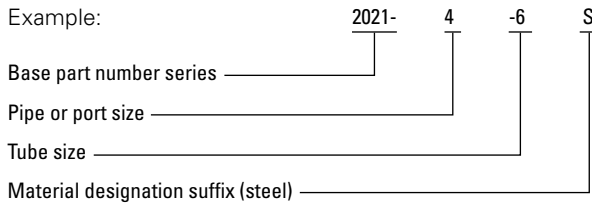

How to order adapters

Adapters are ordered using the complete part number as shown on the adapter pages.

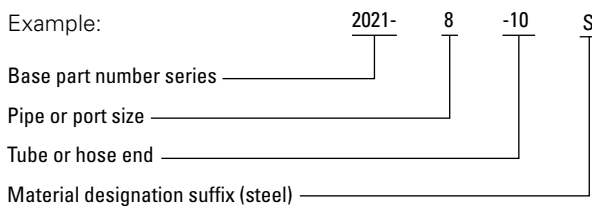

ORS adapters conversion*

ORS adapters come standard with the half dovetail groove design. The half dovetail groove is manufactured with an angle on the OD wall. This angle captures the O-Ring for maximum retention. For ease of installation, a half dovetail groove installation tool may be used.

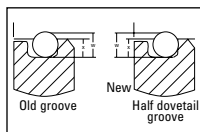

*Eaton reserves the right to use straight groove on some ORS.

Half dovetail groove installation tool

The half dovetail groove installation tool compresses the O-Ring, allowing it to easily slide into the groove in the adapter. Use of the tool maximizes efficiency and minimizes any fatigue that may be associated with repeated insertions over an extended period of time. One tool is required per dash size (or by adapter size). Each tool comes with an illustrated instruction sheet. Tools are available by using the following part numbers: FT1405-04, FT1405-06, FT1405-08, FT1405-10, FT1405-12, FT1405-16, FT1405-20, FT1405-24.



How to order ORS adapters and tube fittings

ORS tube fitting body with O-Ring, locknut and washer, where applicable.

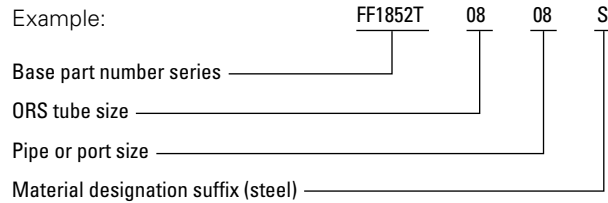

ORS tube fitting body without O-Ring

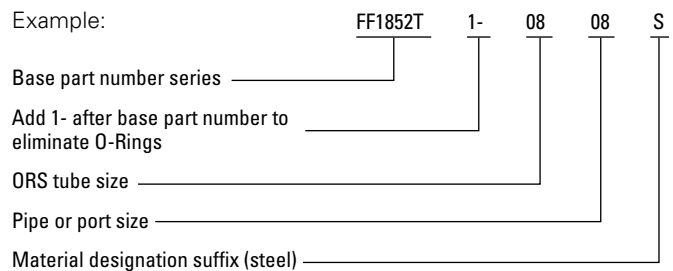

ORS bulkhead tube fitting body without bulkhead nut or O-Ring

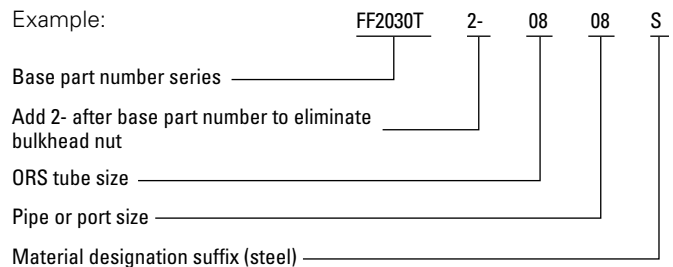

ORS-TF tube fitting components

ORS-TF tube fittings, nut, ferrules, and sleeves can be ordered under the following kit part number:

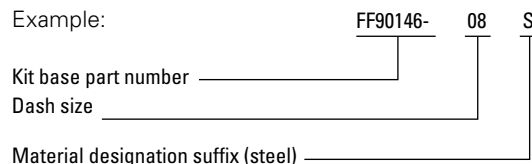

By ordering a single part number in kit form, you will receive the components ready to be assembled to an ORS tube fitting body:

- Example: FF90146-08S includes:
- FC1851-08S (ORS-TF Nut)
 - FF90102-08S (ORS-TF Ferrule)
 - FF90103-08S (ORS-TF Sleeve)

Steel adapters

Part structure

How to order ORS adapters and tube fittings

(continued)

Nuts and shoulders (Braze type)

Nuts and shoulders can be ordered separately. Simply use the base number, dash size, and material designation.

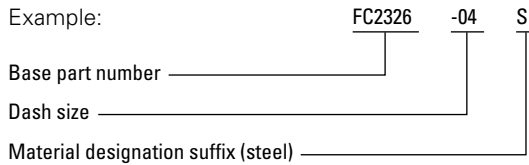

O-Rings

Buna-N O-Rings are standard. Other materials may also be specified by adding a material designator prefix if the part number begins with a numeric, and a material designator suffix if the part number begins with an alpha character. In all cases, the suffix "S" shall be omitted.

Material designation prefix/suffix	Material	Operating temperature range
S	90 Durometer Buna-N Nitrile Rubber	-40°F to +250°F (-40°C to +121°C)
212	80 Durometer EPDM Ethylene propylene diene monomer	-65°F to +300°F (-55°C to +150°C)
213	90 Durometer Viton Fluoroelastomer	-15°F to +400°F (-26°C to +204°C)
214	90 Durometer Buna-N Low temperature Nitrile	-65°F to +225°F (-55°C to +100°C)
352	70 Durometer Neoprene	-65°F to +300°F (-55°C to +150°C)

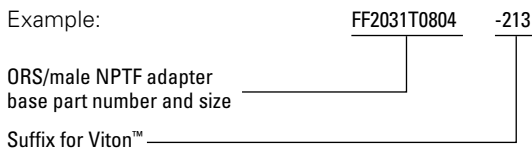

O-Rings can be ordered separately

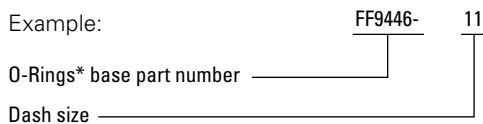

*See ORS O-Ring chart on page 115-117.

Body material

Steel is standard. Other materials may also be specified by adding a material designator prefix if the part number begins with a numeric, and a material designator suffix if the part number begins with an alpha character. In all cases, the suffix "S" shall be omitted.

Material designation prefix/suffix	Material
B (suffix only)	Brass
259	316-Stainless
4	Monel®
S	Steel

How to order Conversion adapters BSPP/BSPT

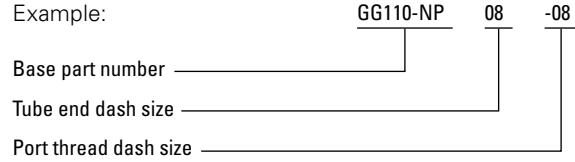

Metric

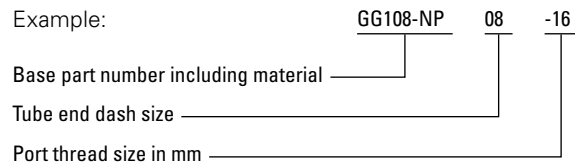

Dimensions

Eaton tube fittings are ordinarily designed and produced to the functional requirements set forth in SAE Standards J512, J513, J514, J1926 and J1453. However, in some cases the envelope dimensions of certain components vary slightly from cataloged or SAE referenced dimensions. The SAE reference numbers and fitting descriptions given are in accordance with SAE Standard J846.

Availability

All items listed in the current price schedule are normally carried in stock. Price and delivery of non-stocked and special parts may be obtained from your Eaton Sales Representative or Distributor.

Loctite™ Vibra-Seal 516 for external pipe threads

Loctite Vibra-Seal has the following characteristics:

- Non-hardening thread sealant
- Resists shredding and peeling during assembly
- Can be reused up to 5 times without recoating
- Provides resistance to vibrational loosening
- Excellent resistance to solvents and oils
- Operating temperatures range -65°F to +250°F

Machine applied so that it leaves first 1/2 to 2 threads uncovered for ease of assembly. Because of the excellent characteristics of this product, we are offering Loctite Vibra-Seal on all of our parts that have male pipe threads. Factory applied Loctite for external pipe threads may be ordered for steel parts by adding the prefix "307-" to the completed part number, and dropping suffix "S" if the part number begins with a numeral. Example: 307-2021-8-8.

If the part number begins with an alpha character, add the suffix "-307" to the completed part number and drop the suffix "S". Example: FF2031T0606-307.

Loctite is a trademark of The Henkel Corporation.

Viton is a trademark of The Chemours Company FC, LLC.

Monel is a registered trademark of Special Metals Corporation group of Companies.

ORS-TF

FC1851
Page 40

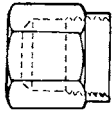

FF90102
Page 40



FF90103
Page 40



ORS braze type

FC1229
(former WH
4165x)
Page 41

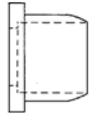

FC2325
Page 41

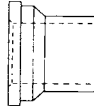

FF1922T
Page 42

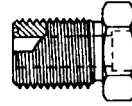

FF1851T
Page 42



ORS braze type (Continued)

FF1856T
Page 42

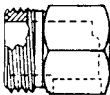

FF1858T
Page 43

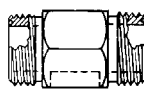

FF2115T
Page 43

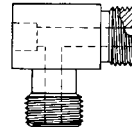

FC2326
(former WH
4105x)
Page 43



ORS/SAE O-Ring boss

FF1852T
(former WH
4315x)
Page 44

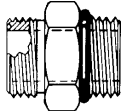

F2211T
Page 45

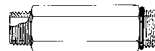

FF1854T
(former WH
4316x)
Page 45

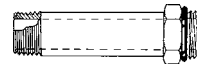

FF2130T
Page 45

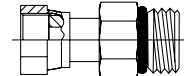

ORS/SAE O-Ring boss (Continued)

FF1868T
(former WH
4515x)
Page 46

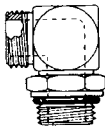

FF2227T
(former WH
4515x-L)
Page 47

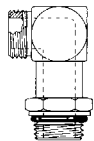

FF2068T
(former WH
4365x)
Page 47

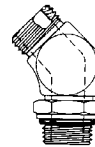

ORS/SAE O-Ring boss (Continued)

FF1861T
(former WH
4715x)
Page 48

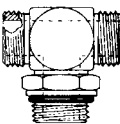

FF1865T
(former WH
4716x)
Page 48

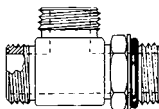

ORS-NPTF

FF2031T
(former WH
4205x)
Page 49

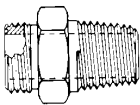

FF2093T
(former WH
4355x)
Page 49

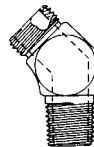

FF2032T
(former WH
4405x)
Page 50

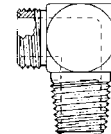

FF2001T
Page 50

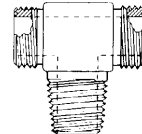

ORS to SAE 37° flare

FF2209T
(former WH
4213x)
Page 51

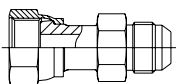

FF2313T
Page 51

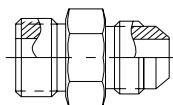

Items in parentheses are equivalent to former Weatherhead part series.

Steel adapters

Configuration index

ORS/ORS

FF2000T
(former WH
4305x)
Page 52

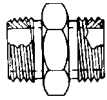

FF2281T
Page 52

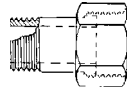

FF1994T
(former WH
4325x)
Page 53

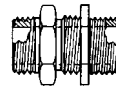

FF2133T
Page 53

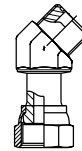

ORS/ORS (Continued)

FF2144T
Page 53

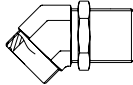

FF2098T
(former WH
4506x)
Page 53

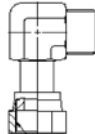

FF2035T
(former WH
4505x)
Page 54

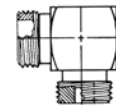

ORS/ORS (Continued)

FF2030T
(former WH
4525x)
Page 54

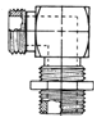

FF1898T
(former WH
4706x)
Page 54

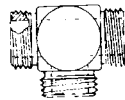

FF2174T
(former WH
4726x)
Page 55

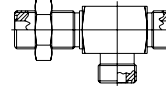

ORS/ORS (Continued)

FF1857T
(former WH
4707x)
Page 55

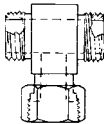

FF2114T
(former WH
4706x)
Page 55

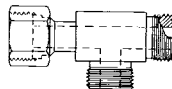

FF2033T
Page 55

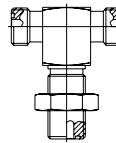

ORS accessories

FF9768
(former WH
4924x)
Page 56



FF9767T
(former WH
4229x)
Page 56



FF9863
(former WH
4129x)
Page 56

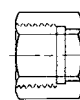

ORS accessories (Continued)

FF9766
Page 57



FF9075
ORS silver
braze ring
Page 57



SAE O-Ring boss/SAE O-Ring boss

FF1010
(former WH
7033x)
Page 58



900598
(former WH
7237x)
Page 58



FF2138
(former WH
7238x)
Page 59

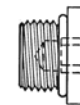

2220
(former WH
C5314x)
Page 59

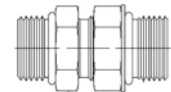

SAE O-Ring boss/SAE O-Ring boss (Continued)

FF1796 (former
WH C3249x)
Page 59

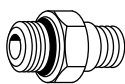

2229
Page 60



FF2591
Page 60

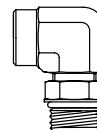

FF1167
Page 60

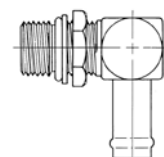

Items in parentheses are equivalent to former Weatherhead part series.

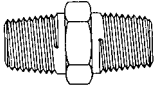
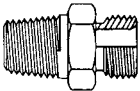
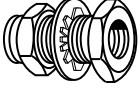
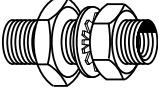

Pipe to pipe

2083 (former WH C3069x) Page 61		2015 Page 61		FF4183 (former WH W series) Page 62		FF4185 (former WH W series) Page 62	
---------------------------------------	---	-----------------	---	---	--	---	---

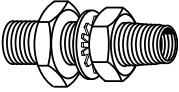
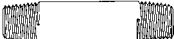
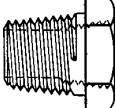
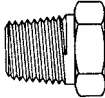

Pipe to pipe (Continued)

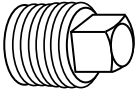
FF4186 (former WH W series) Page 62		2084 Page 63		2081 (former WH C3109x) Page 63		2082 (former WH C3159x) Page 64	
---	---	-----------------	---	---------------------------------------	--	---------------------------------------	---

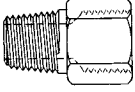
Pipe to pipe (Continued)

FF4177 (former WH C3179x) Page 64		FF91494 (former WH C3059x) Page 64		2222 (former WH C3169x) Page 65		2040 (former WH C3209x) Page 65	
---	---	--	---	---------------------------------------	--	---------------------------------------	---

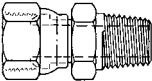
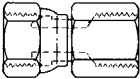
Pipe to pipe (Continued)

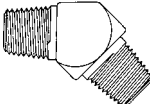
2045 (former WH 9205x) Page 66		2046 (former WH 9255x) Page 66		2096 (former WH C3309x) Page 67		2247 Page 67	
--------------------------------------	--	--------------------------------------	--	---------------------------------------	---	-----------------	--

Pipe to pipe (Continued)

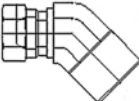
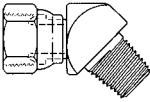
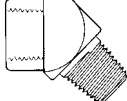
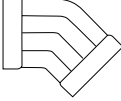
2050 (former WH 9385x) Page 67		2049 (former WH 9355x) Page 68		2088 (former WH C3359x) Page 68		2086-S (former WH C3559x) Page 69	
--------------------------------------	---	--------------------------------------	---	---------------------------------------	--	---	---

Pipe to pipe (Continued)

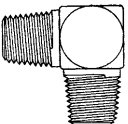
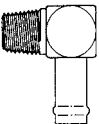
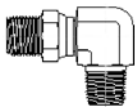
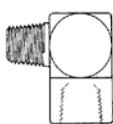
2085 (former WH C3529x) Page 69		FF1162 Page 70		2251 (former WH 9435x) Page 70		2089 (former WH C3409) Page 70	
---------------------------------------	---	-------------------	---	--------------------------------------	--	--------------------------------------	---

Pipe to pipe (Continued)

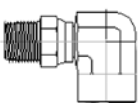
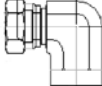
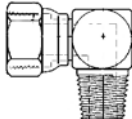
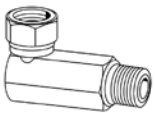
2252 Page 71		2048 (former WH 9455) Page 71		2047 (former WH 9405x) Page 72		FF4175 (former WH 9405xLL) Page 72	
-----------------	---	-------------------------------------	---	--------------------------------------	--	--	---

Pipe to pipe (Continued)

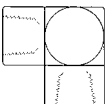
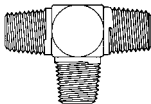
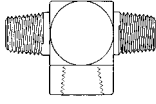
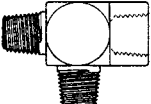
2087 (former WH C3509x) Page 73		2257 Page 73		2256 Page 74		2093 (former WH C3805x) Page 74	
---------------------------------------	---	-----------------	---	-----------------	--	---------------------------------------	---

Items in parentheses are equivalent to former Weatherhead part series.

Steel adapters

Configuration index

Pipe to pipe (Continued)

2092
(former WH
C3759x)
Page 74

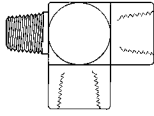

2254
(former WH
9406x)
Page 75

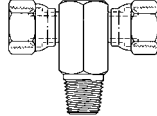

2255
(former WH
9705x)
Page 75

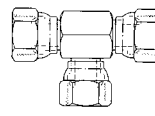

2253
(former WH
9456x)
Page 75

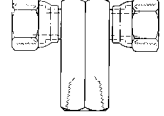

Pipe to pipe (Continued)

2091
(former WH
C3609x)
Page 76

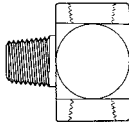

2090
(former WH
C3709x)
Page 76

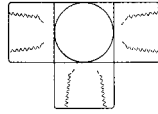

2080
(former WH
C3959x)
Page 76

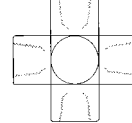

Pipe to SAE 37° flare

2021
(former WH
C5205x)
Page 77

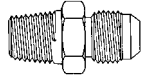

2240
Page 78

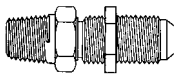

202113
Page 78

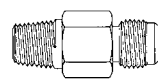

202114
Page 78

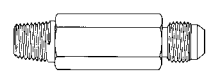

Pipe to SAE 37° flare (Continued)

2239
(former WH
C5275x)
Page 79

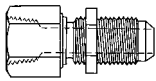

2018
(former WH
9100x)
Page 79

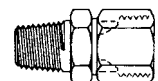

2242
(former WH
C5256x)
Page 79

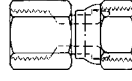

2022
(former WH
C5255x)
Page 80

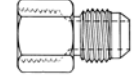

Pipe to SAE 37° flare (Continued)

2044
Page 80

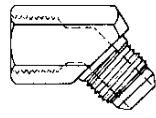

2023
(former WH
C5355x)
Page 81

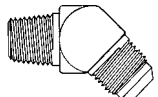

2243
Page 81

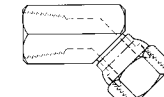

2024
(former WH
C5405x)
Page 82

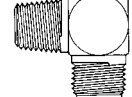

Pipe to SAE 37° flare (Continued)

202411
(former WH
C5425x)
Page 83

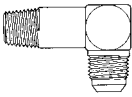

202413
(former WH
C5435x)
Page 83

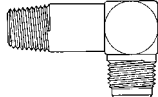

202414
Page 84

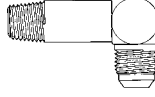

2250
(former WH
C5406x)
Page 84

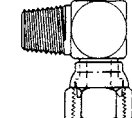

Pipe to SAE 37° flare (Continued)

2249
Page 84

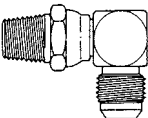

2244
Page 85

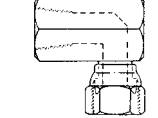

2025
(former WH
C5455x)
Page 85

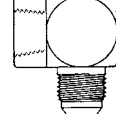

203007
Page 85

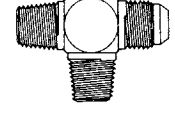

Pipe to SAE 37° flare (Continued)

203301
Page 86

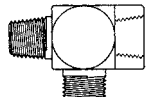

203103
Page 86

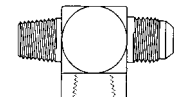

2028
(former WH
C5755x)
Page 86

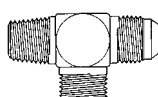

203006
Page 87

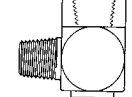

Items in parentheses are equivalent to former Weatherhead part series.

Pipe to SAE 37° flare (Continued)

2030
(former WH
C5605x)
Page 87

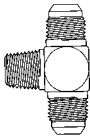

202901
Page 87

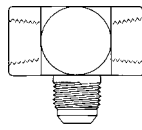

203104
Page 87

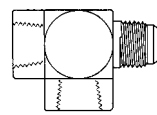

2029
(former WH
C5805x)
Page 88

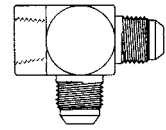

Pipe to SAE 37° flare (Continued)

2031
(former WH
5655x)
Page 88

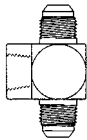

202003
Page 88

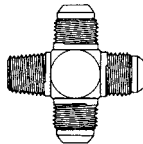

Pipe to 45° flare - Brass

2000
Page 89

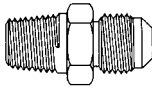

2001
Page 89

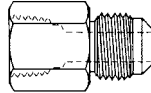

2007
Page 90

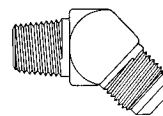

Pipe to 45° flare - Brass (Continued)

2002
Page 90

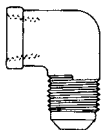

2003
Page 90

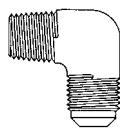

Pipe to SAE O-Ring boss

2246
(former WH
C3239x)
Page 91

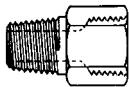

2066
(former WH
9315x)
Page 91

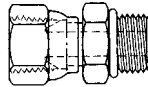

2216
(former WH
C3269x)
Page 92

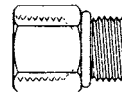

2067
(former WH
9365x)
Page 92

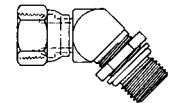

Pipe to SAE O-Ring boss (Continued)

2068
(former WH
9515x)
Page 93

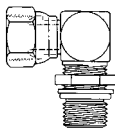

206801
(former WH
C3459x)
Page 93

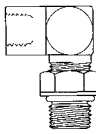

206804
(former WH
C3469x)
Page 93

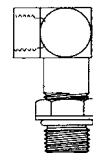

Pipe to braze and weld

73056
Page 94

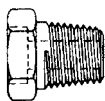

FF1159
Page 94

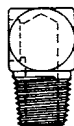

SAE 37° (JIC) flare union

2027
(former WH
C5305x)
Page 94

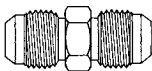

202712
(former WH
C5306x)
Page 95

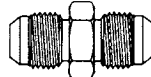

2041
(former WH
C5325x)
Page 95

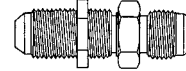

900599
(former WH
C5229x)
Page 95

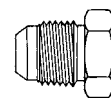

Items in parentheses are equivalent to former Weatherhead part series.

Steel adapters

Configuration index

SAE 37° (JIC) flare union (Continued)

210292
(former WH
C5129x)
Page 96

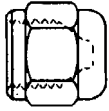

2215
(former WH
C5015x)
Page 96

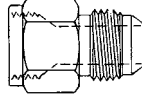

221501
(former WH
C5015x)
Page 97

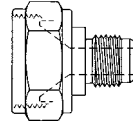

2042
(former WH
C5375x)
Page 97

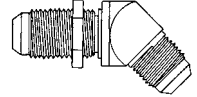

SAE 37° (JIC) flare union (Continued)

2070
(former WH
C5356x)
Page 97

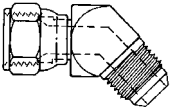

2039
(former WH
C5505x)
Page 98

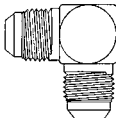

2043
(former WH
C5525x)
Page 98

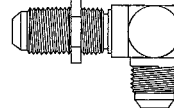

2071
(former WH
C5506x)
Page 98

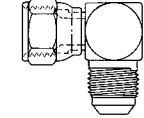

SAE 37° (JIC) flare union (Continued)

FF5163
Page 99

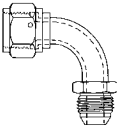

500454
Page 99

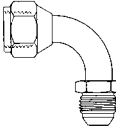

504095
Page 99

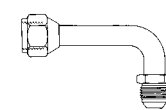

FF5164
Page 100

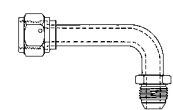

SAE 37° (JIC) flare union (Continued)

2033
(former WH
5705x)
Page 100

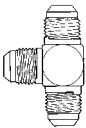

203002
(former WH
C5725x)
Page 100

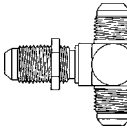

203008
Page 101

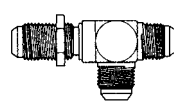

203101
(former WH
C5707x)
Page 101

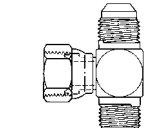

SAE 37° (JIC) flare union (Continued)

203102
(former WH
C5706x)
Page 101

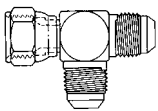

2020
(former WH
C5955x)
Page 102

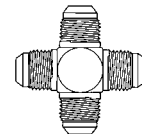

210212
(former WH
C5924x)
Page 102



SAE 45° flare union

2056
Page 103

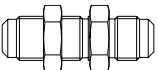

2060
Page 103

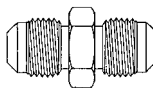

FF4174
(former WH
9154x)
Page 103

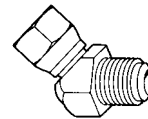

SAE O-Ring boss to SAE 37° flare

202702
(former WH
C5315x)
Page 104-105

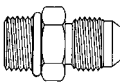

202713
(former WH
C5316x)
Page 105

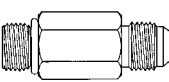

2266
(former WH
C5216x)
Page 105

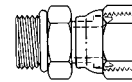

2061
(former WH
C5365x)
Page 106

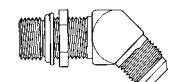

SAE O-Ring boss to SAE 37° flare (Continued)

206209
(former WH
C5515xLL)
Page 106

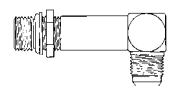

2062
(former WH
C5515x)
Page 107

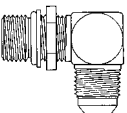

203005
(former WH
C5716x)
Page 108

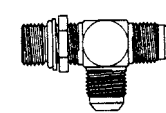

203003
(former WH
C5715x)
Page 108

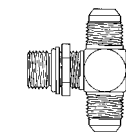

FF3910
(former WH
C5515xL)
Page 106

Items in parentheses are equivalent to former Weatherhead part series.

SAE split flange to ORS

FF5943T
Page 114



FF6001T
Page 114

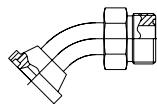

FF6002T
Page 114

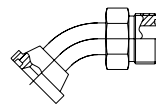

SAE split flange to ORS (Continued)

FF5946T
Page 115

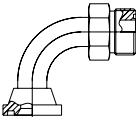

FF5945T
Page 115

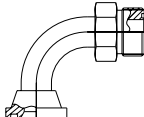

FF6062T
Page 115

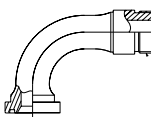

FF2522T
Page 115

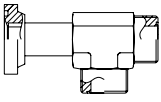

SAE split flange to SAE 37° flare

500025
(former WH 500 series)
Page 116

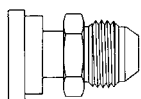

FF5239
(former WH 500 series)
Page 116

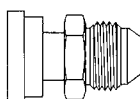

FF5541
(former WH 600 series)
Page 116

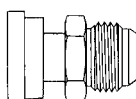

FF5539
(former WH 645 series)
Page 117



SAE split flange to SAE 37° flare (Continued)

500023
(former WH 545 series)
Page 117

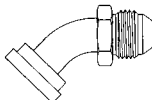

FF5238
(former WH 545 series)
Page 117



500024
(former WH 590 series)
Page 118

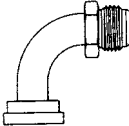

SAE split flange to SAE 37° flare (Continued)

FF5162
Page 118

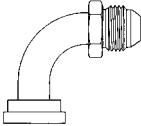

FF5540
Page 119

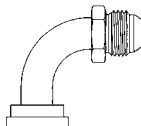

SAE swivel flange to SAE split flange

504089
Page 119

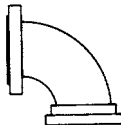

FF5321
Page 119

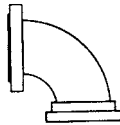

SAE flareless to 37° union

FF1315
Page 120



210294
Page 120



FF9173
Page 120

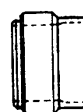

Braze and weld to split flange

71418
Page 121

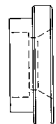

4624
Page 121



71416
Page 122

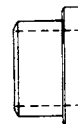

71422
Page 122

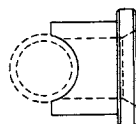

Items in parentheses are equivalent to former Weatherhead part series.

Steel adapters

Configuration index

Braze and weld to split flange (Continued)

FC1102
Page 122

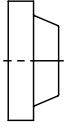

FC1132
Page 122

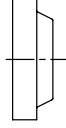

Braze and weld to SAE 37° flare

202232
Page 123

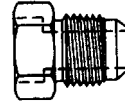

73014
Page 123

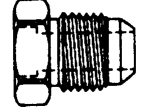

Versil-Flare™ - flareless and flare

FC2875
Page 126

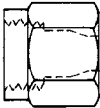

FF9605
Page 126

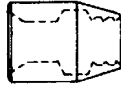

221000
(former WH C5115x)
Page 126

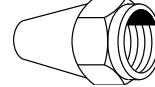

1290
(former WH C5105x)
Page 127

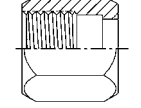

Versil-Flare™ (Continued)

900605
(former WH C5165x)
Page 127



Specials

2004
(former WH C92 series)
Page 128

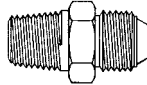

202124/FF1327
(former WH C5880x)
Page 128

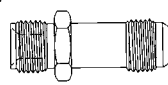

200001
Page 128

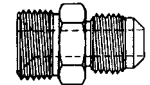

Specials (Continued)

FT1353/FF1354
Page 129

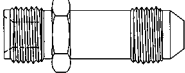

FF1980
Page 129

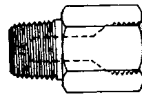

FF1981
Page 129

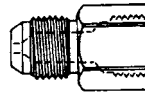

FF4184
(former WH 41157x)
Page 129

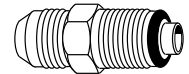

Metric to SAE 37° flare

15.063
(former WH MC5206x)
Page 131

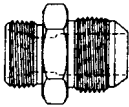

15.147
(former WH MC5208x)
Page 131

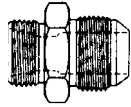

15.117
(former WH MC5207x)
Page 131

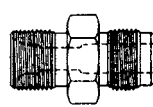

15.164
Page 132

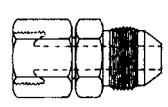

Metric to SAE 37° flare (Continued)

FF4215
(former WH M41157x)
Page 132

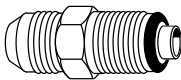

15.163
Page 132

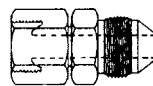

15.165
Page 133

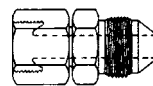

Metric to SAE 37° flare (Continued)

GG108-NP
(former WH MC5315x)
Page 133

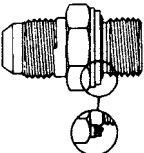

GG308-NP
(former WH MC5515x)
Page 133

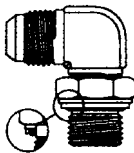

ORS to metric

FF2485T
Page 134

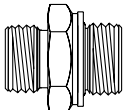

FF2742T
Page 134

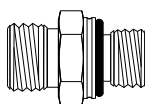

FF2744T
Page 134

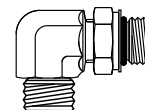

Items in parentheses are equivalent to former Weatherhead part series.

Metric sleeve

FF91488
(former WH
C5165x_M)
Page 135

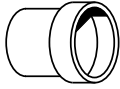

Pipe to metric

FF4180
(former WH
M9700x)
Page 135

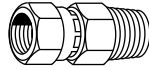

BSPP to SAE 37° flare

2063
Page 136

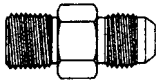

GG106-NP
(former WH
MB5315x)
Page 136

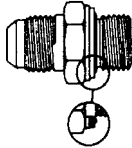

GG306-NP
(former WH
MB5515x)
Page 137

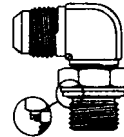

FF4179
(former WH
M9600x)
Page 137

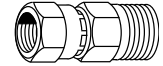

BSPT to SAE 37° flare

GG110-NP
(former WH
MC5205x)
Page 137



GG310-NP
(former WH
MC5405x)
Page 138

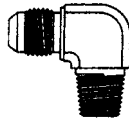

FF4181
(former WH
M9800x)
Page 138

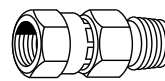

JIS 30° to SAE 37° flare

FF2593
Page 138

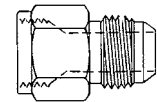

Stainless steel - Pipe to pipe

259-2083
(former WH
3081x)
Page 61

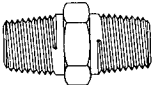

259-2081
(former WH
3121x)
Page 63

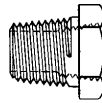

259-2082
(former WH
3171x)
Page 64

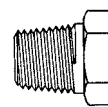

259-2096
(former WH
3321x)
Page 67

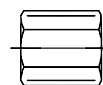

Stainless steel - Pipe to pipe (Continued)

259-2089
(former WH
3421x)
Page 70

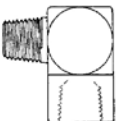

259-2087
(former WH
3521x)
Page 73

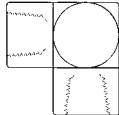

259-2091
Page 76

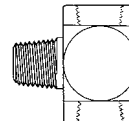

Stainless steel - Pipe to SAE 37° flare

259-2021
(former WH
5217x)
Page 77

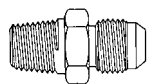

259-2240
Page 78

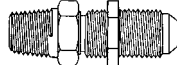

259-2022
(former WH
5267x)
Page 80

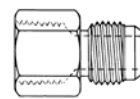

Stainless steel - Pipe to SAE 37° flare (Continued)

259-2023
(former WH
5367x)
Page 81

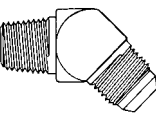

259-2024
(former WH
5417x)
Page 82

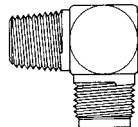

Stainless steel - SAE 37° (JIC) flare union

259-2027
(former WH
5317x)
Page 94

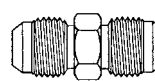

259-2041
(former WH
5337x)
Page 95

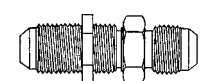

Stainless steel - SAE 37° (JIC) flare union (Continued)

259-900599
(former WH
C5241x)
Page 95

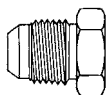

259-210292
(former WH
5141x)
Page 96

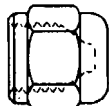

259-2071
(former WH
5518x)
Page 98

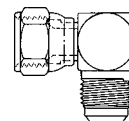

259-210212
(former WH
7936x)
Page 102



Items in parentheses are equivalent to former Weatherhead part series.

Steel adapters

Configuration index

Stainless steel - SAE O-Ring to SAE 37°

259-202702
(former WH
5327x)
Page 104-105

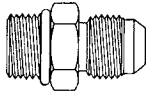

Stainless steel - Versil-Flare™ flareless and flare

259-1290
(former WH
5117x)
Page 127

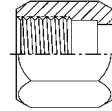

259-900605
(former WH
5177x)
Page 127

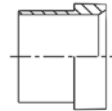

Ermeto

7165X
Page 144



8165X
Page 144



7105X
Page 144



8112X
Page 144

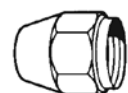

Ermeto (Continued)

7129X
Page 145

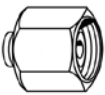

7229X
Page 145

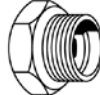

7015X
Page 145

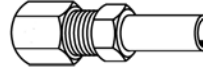

7305X
Page 146

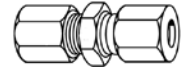

Ermeto (Continued)

7306X
Page 146

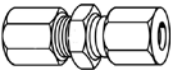

7325X
Page 146

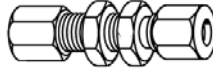

7205X
Page 147

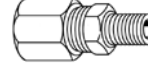

7255X
Page 147



Ermeto (Continued)

7315X
Page 148

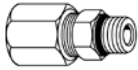

7355X
Page 148



7505X
Page 148

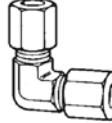

7405X
Page 149



Ermeto (Continued)

7455X
Page 149

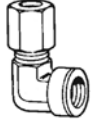

7515X
Page 150



7705X
Page 150

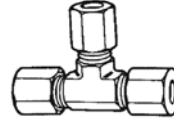

Ermeto (Continued)

7755X
Page 150

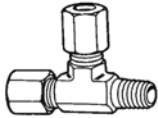

7805X
Page 151

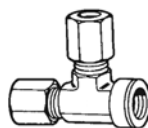

7716X
Page 151

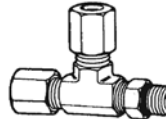

Ermeto (Continued)

7605X
Page 152

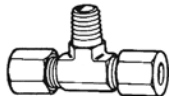

7655X
Page 152

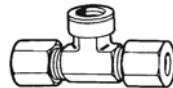

Reminder – different types of adapters have different part number configurations.

See page 27 for instructions and examples of how to read and order different part number configurations.

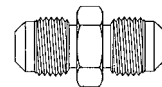

SAE

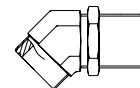

ORS

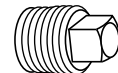

Pipe

Items in parentheses are equivalent to former Weatherhead part series.

ORS connections

The Eaton ORS™ connection is the universal answer to troublesome fluid leakage problems

ORS connection hose assembly

The ORS connection can be used with flexible hydraulic hose, combining the reusability of the hose fitting and the ORS connection. The result is the ultimate reusable fitting.

ORS connection hose assembly

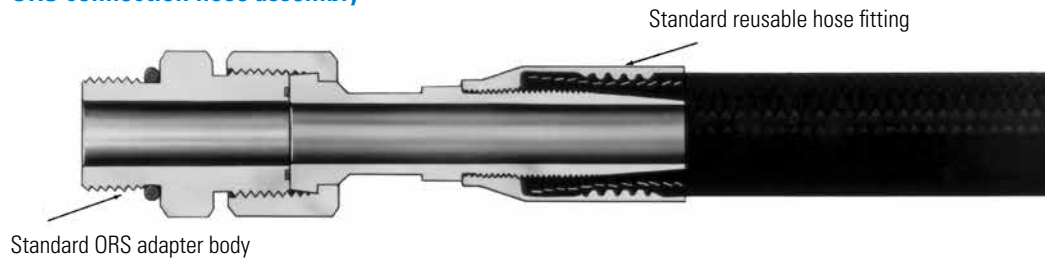

ORS Tube assemblies

The ORS connection can be attached to hydraulic tubing to make a tube assembly.

Two methods of attachment are available:

- ORS-TF:** The ORS female can be jointed directly to steel tubing with the ORS-TF (wedge-type) tube fitting, another Eaton innovation. The fitting becomes an integral part of your system at a fraction of the time and expense brazing requires. The versatility these options provides make ORS the only connection you need for high-pressure situations. It attaches to most types of fluid conveying lines, controlling most types of fluid, facing the toughest conditions.
- ORS-braze type:** The ORS component can be brazed to hydraulic tubing

ORS-TF tube assembly

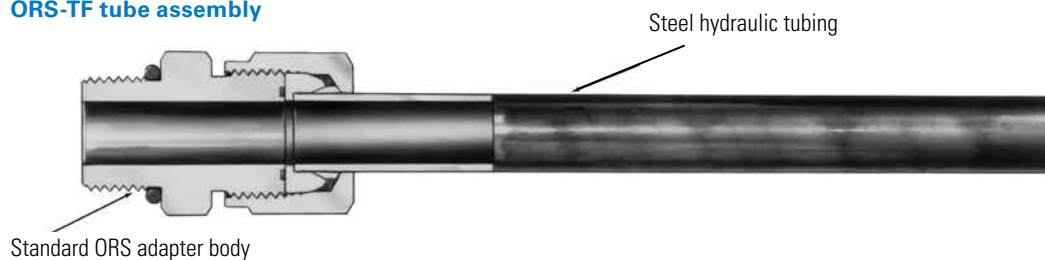

ORS-braze type tube assembly

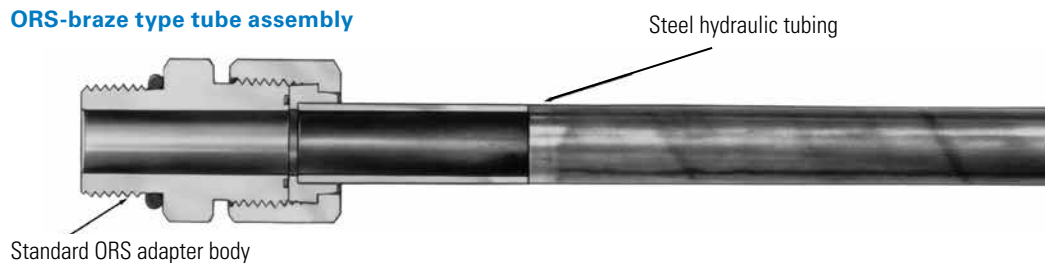

Steel adapters

ORS-TF tube fittings

ORS-TF tube fittings

The ORS-TF tube fitting utilizing the ORS-TF nut, ferrule and sleeve can be joined directly to steel tubing to solve your fluid leakage problems. It does not require the time and expense of brazing and provides the advantage of repetitive reuse. It is a compression type fitting that works on a variety of tubing.

Keep it simple and clean with ORS

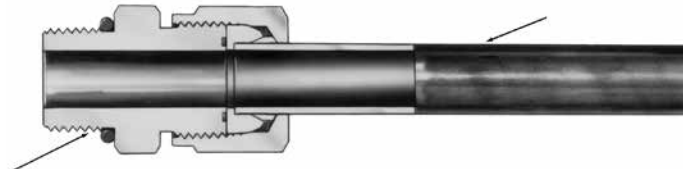

ORS-TF kit FF90146-(Size)

Includes:

- FC1851 ORS-TF Nut
- FF90102 ORS-TF Ferrule
- FF90103 ORS-TF Sleeve

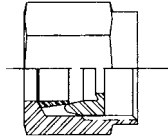

ORS-TF Nut

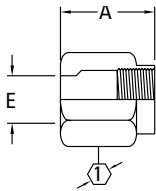

FC1851-(Dash size)

Dash size	Tube O. D.		Thread T1	A		E		①	
	mm	in		mm	in	mm	in	mm	in
04S	6,3	0.25	9/16-18	21,3	0.84	6,6	0.26	17,5	0.69
06S	9,6	0.38	11/16-16	23,6	0.93	9,6	0.38	20,6	0.81
08S	12,7	0.50	13/16-16	26,9	1.06	12,9	0.51	23,9	0.94
10S	16,0	0.63	1-14	28,7	1.13	16,0	0.63	28,4	1.12
12S	19,0	0.75	1 3/16-12	32,5	1.28	19,3	0.76	35,0	1.38
16S	25,4	1.00	1 7/16-12	34,3	1.35	25,6	1.01	41,1	1.62
20S	31,7	1.25	1 11/16-12	35,8	1.41	32,0	1.26	47,7	1.88
24S	38,1	1.50	2-12	37,3	1.47	38,3	1.51	57,1	2.25

ORS-TF Ferrule

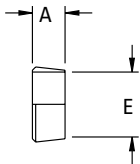

FF90102-(Dash size)

Dash size	Tube O. D.		A		E	
	mm	in	mm	in	mm	in
FF90102-04S	6,3	0.25	6,3	0.25	6,6	0.26
FF90102-06S	9,6	0.38	6,3	0.25	9,6	0.38
FF90102-08S	12,7	0.50	7,6	1.50	12,9	0.51
FF90102-10S	16,0	0.63	7,6	1.50	16,0	0.63
FF90102-12S	19,0	0.75	7,6	1.50	19,3	0.76
FF90102-16S	25,4	1.00	7,6	1.50	25,6	1.01
FF90102-20S	31,7	1.25	7,6	1.50	32,0	1.26
FF90102-24S	38,1	1.50	7,6	1.50	38,3	1.51

ORS-TF Sleeve

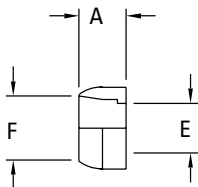

FF90103-(Dash size)

Dash size	Tube O. D.		A		E		F	
	mm	in	mm	in	mm	in	mm	in
FF90103-04S	6,3	0.25	8,1	0.32	4,3	0.17	6,3	0.25
FF90103-06S	9,6	0.38	8,6	0.34	6,6	0.26	9,6	0.38
FF90103-08S	12,7	0.50	9,4	0.37	9,6	0.38	12,7	0.50
FF90103-10S	16,0	0.63	10,2	0.40	12,2	0.48	16,0	0.63
FF90103-12S	19,0	0.75	11,2	0.44	15,5	0.61	19,3	0.76
FF90103-16S	25,4	1.00	12,7	0.50	20,6	0.81	25,4	1.00
FF90103-20S	31,7	1.25	14,2	0.56	26,7	1.05	32,0	1.26
FF90103-24S	38,1	1.50	15,7	0.62	32,0	1.26	38,3	1.51

Material: Corrosion-resistant plated steel.

ORS braze type

ORS-BR shoulder internal braze

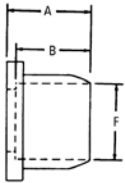

CAUTION

In applications exceeding +480°F (such as during brazing) order the oil-coated/ non-plated nut by using part number FC1857- Size-186. When plating is heated above +480°F, toxic gases are given off.

FC1229-(Dash size)* (Ref. SAE 520115)
(Formerly Weatherhead Series 4165x)

Dash size	Tube O. D.		A		B		F	
	mm	in	mm	in	mm	in	mm	in
0404S	6,4	0.25	7,4	0.29	6,4	0.25	6,4	0.25
0606S	9,7	0.38	7,4	0.29	6,4	0.25	9,7	0.38
0808S	12,7	0.50	10,7	0.42	9,7	0.38	12,7	0.50
1212S	19,0	0.75	11,2	0.44	9,7	0.38	19,0	0.75
1616S	25,4	1.00	14,2	0.56	12,7	0.50	25,4	1.00
2020S	31,8	1.25	14,2	0.56	12,7	0.50	31,8	1.25
2424S	38,1	1.50	14,2	0.56	12,7	0.50	38,1	1.50

*Eaton braze counterbores are dimensioned for sized or emeryed tubing. If tubing is used as received, contact Eaton for appropriate part number.

ORS-BR shoulder external braze/weld

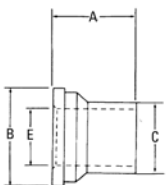

CAUTION

In applications exceeding +480°F (such as during brazing) order the oil-coated/ non-plated nut by using part number FC1857- Size-186. When plating is heated above +480°F, toxic gases are given off.

FC2325-(Dash size)* (Ref. SAE 520172)

Dash size	Tube O. D.		A		B		C		E	
	mm	in	mm	in	mm	in	mm	in	mm	in
0404S	6,4	0.25	22,3	0.88	12,7	0.50	6,4	0.25	4,3	0.17
0606S	9,7	0.38	24,4	0.96	15,7	0.62	9,7	0.38	6,6	0.26
0808S	12,7	0.50	31,8	1.25	18,8	0.74	12,7	0.50	9,1	0.36
1010S	16,0	0.63	34,0	1.34	23,4	0.92	15,7	0.62	11,4	0.45
1212S	19,0	0.75	36,6	1.44	27,7	1.09	19,0	0.75	14,0	0.55
1616S	25,4	1.00	41,4	1.63	34,0	1.34	25,4	1.00	19,8	0.78
2020S	31,8	1.25	41,4	1.63	40,4	1.59	31,8	1.25	26,7	1.05
2424S	38,1	1.50	41,4	1.63	48,5	1.91	38,1	1.50	32,0	1.26

*Eaton braze counterbores are dimensioned for sized or emeryed tubing. If tubing is used as received, contact Eaton for appropriate part number.

Steel adapters

ORS braze type

ORS braze type

ORS bulkhead male/braze adapter

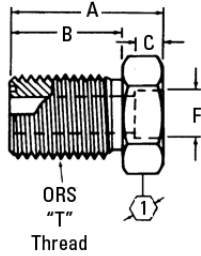

FF1922T(Dash size)* (Ref. SAE 520604)

Dash size	Tube O. D.		Thread T1	A		B		C		D		①
	mm	in		mm	in	mm	in	mm	in	mm	in	
0606S	9,7	0.38	11/16-16	43,7	1.72	34,0	1.34	6,4	0.25	9,7	0.38	1.00
1010S	16,0	0.63	1-14	53,6	2.11	40,6	1.60	9,7	0.38	15,7	0.62	1.31
1212S	19,0	0.75	1 3/16-12	55,4	2.18	41,6	1.64	9,7	0.38	19,0	0.75	1.50
1616S	25,4	1.00	1 7/16-12	61,7	2.43	42,2	1.66	12,7	0.50	25,4	1.00	1.75

ORS/braze adapter

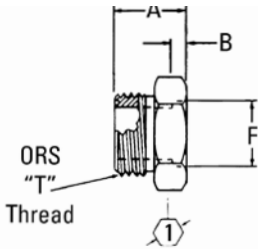

FF1851T(Dash size)* (Ref. SAE 520104)

Dash size	Tube O. D.		Thread T1	A		B		F		①
	mm	in		mm	in	mm	in	mm	in	
0404S	6,4	0.25	9/16-18	19,8	0.78	6,4	0.25	6,4	0.25	0.62
0606S	9,7	0.38	11/16-16	21,0	0.83	6,4	0.25	9,7	0.38	0.75
0608S	9,7	0.38	11/16-16	24,1	0.95	9,7	0.38	12,7	0.50	0.75
0808S	12,7	0.50	13/16-16	25,8	1.01	9,5	0.38	12,8	0.50	0.88
1010S	16,0	0.63	1-14	28,5	1.12	9,7	0.38	15,7	0.62	1.06
1212S	19,0	0.75	1 3/16-12	30,7	1.21	9,7	0.38	19,0	0.75	1.25
1216S	19,0	0.75	1 3/16-12	36,8	1.45	12,7	0.50	25,4	1.00	1.50
1612S	25,4	1.00	1 7/16-12	30,7	1.21	9,7	0.38	19,0	0.75	1.50
1616S	25,4	1.00	1 7/16-12	37,3	1.47	12,7	0.50	25,4	1.00	1.50
1620S	25,4	1.00	1 7/16-12	37,3	1.47	12,7	0.50	31,8	1.25	1.75
2020S	31,8	1.25	1 11/16-12	37,3	1.47	12,7	0.50	31,8	1.25	1.75
2424S	38,1	1.50	2-12	37,3	1.47	12,7	0.50	38,1	1.50	2.12

*Eaton braze counterbores are dimensioned for sized or emeryed tubing. If tubing is used as received, contact Eaton for appropriate part number.

90° ORS/braze port adapter

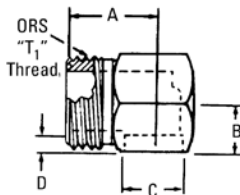

FF1856T(Dash size)* (Ref. SAE 520204)

Dash size	Tube O. D.		Thread T1	A		B		C		D	
	mm	in		mm	in	mm	in	mm	in	mm	in
0606S	9,7	0.38	11/16-16	24,9	0.98	10,4	0.41	9,7	0.38	6,4	0.25
0808S	12,7	0.50	13/16-16	27,9	1.10	15,0	0.59	12,7	0.50	9,7	0.38
1010S	16,0	0.63	1-14	33,3	1.31	16,8	0.66	15,7	0.62	9,7	0.38
1212S	19,0	0.75	1 3/16-12	37,3	1.47	18,3	0.72	19,0	0.75	9,7	0.38
1616S	25,4	1.00	1 7/16-12	41,6	1.64	23,9	0.94	25,4	1.00	13,2	0.52
1820S	25,4	1.00	1 7/16-12	44,7	1.76	28,5	1.12	31,8	1.25	13,5	0.53
2424S	38,1	1.50	2-12	48,8	1.92	31,8	1.25	38,1	1.50	13,2	0.52

ORS braze type

ORS/ORS/braze port adapter

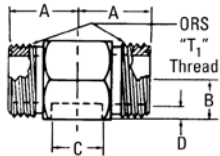

FF1858T(Dash size)* (Ref. SAE 520472)

Dash size	Tube O. D.		Thread T1	A		B		C		D	
	mm	in		mm	in	mm	in	mm	in	mm	in
0606S	9,7	0.38	11/16-16	24,9	0.98	9,9	0.39	9,7	0.38	6,4	0.25
1616S	25,4	1.00	1 7/16-12	41,6	1.64	23,1	0.91	25,4	1.00	13,2	0.52

ORS/braze/ORS port adapter

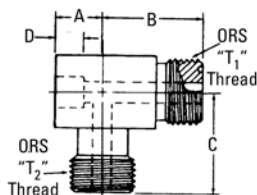

FF2115T(Dash size)* (Ref. SAE 520472)

Dash size	Tube O. D.		Thread T1	Thread T2	A		B		C		D	
	mm	in			mm	in	mm	in	mm	in	mm	in
0606S	9,7	0.38	11/16-16	11/16-16	10,4	0.41	24,9	0.98	24,9	0.98	6,4	0.25

*Eaton braze counterbores are dimensioned for sized or emerged tubing. If tubing is used as received, contact Eaton for appropriate part number.

ORS-BR nut

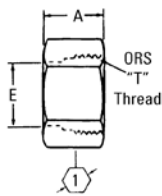

FC2326-(Dash size) (Ref. SAE 520110)
(Formerly Weatherhead Series 4105x)

Dash size	Tube O. D.		Thread T1	A		E		①	
	mm	in		mm	in	mm	in		
04S	6,4	0.25	9/16-18	14,7	0.58	10,4	0.41	17,5	0.69
06S	9,7	0.38	11/16-16	17,0	0.67	13,5	0.53	20,6	0.81
08S	12,7	0.50	13/16-16	21,0	0.83	16,5	0.65	23,9	0.94
10S	16,0	0.63	1-14	23,4	0.92	21,0	0.83	28,5	1.12
12S	19,0	0.75	1 3/16-12	25,9	1.02	24,1	0.95	35,1	1.38
16S	25,4	1.00	1 7/16-12	27,9	1.10	29,0	1.14	41,1	1.62
20S	31,8	1.25	1 11/16-12	27,9	1.10	36,1	1.42	47,7	1.88
24S	38,1	1.50	2-12	27,9	1.10	43,9	1.73	57,2	2.25

CAUTION

In applications exceeding +480°F (such as during brazing) order the oil-coated/non-plated nut by using part number FC1857- Size-186. When plating is heated above +480°F, toxic gases are given off.

Steel adapters

ORS/SAE O-Ring boss

ORS/SAE O-Ring boss

ORS/SAE O-Ring boss adapter

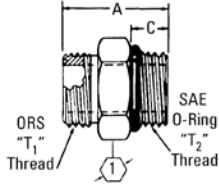

FF1852T(Dash size) (Ref. SAE 520120)
(Formerly Weatherhead Series 4315x)

Dash size	Tube O. D.		Thread T1	Thread T2	A		C		①	
	mm	in			mm	in	mm	in	mm	in
0403S	6,4	0.25	9/16-18	3/8-24	27,2	1.07	9,4	0.37	15,7	0.62
0404S	6,4	0.25	9/16-18	7/16-20	28,7	1.13	10,9	0.43	15,7	0.62
0405S	6,4	0.25	9/16-18	1/2-20	28,7	1.13	10,9	0.43	15,7	0.62
0406S	6,4	0.25	9/16-18	9/16-18	30,5	1.20	11,9	0.47	17,5	0.69
0408S	6,4	0.25	9/16-18	3/4-16	33,6	1.32	14,0	0.55	22,4	0.88
0603S	9,7	0.38	11/16-16	3/8-24	32,5	1.28	9,4	0.37	19,1	0.75
0604S	9,7	0.38	11/16-16	7/16-20	34,0	1.34	10,9	0.43	19,1	0.75
0605S	9,7	0.38	11/16-16	1/2-20	31,0	1.22	10,9	0.43	19,1	0.75
0606S	9,7	0.38	11/16-16	9/16-18	32,0	1.26	11,9	0.47	19,1	0.75
0608S	9,7	0.38	11/16-16	3/4-16	35,1	1.38	14,0	0.55	22,4	0.88
0610S	9,7	0.38	11/16-16	7/8-14	38,9	1.53	16,0	0.63	25,4	1.00
0612S	9,7	0.38	11/16-16	1 1/16-12	42,9	1.69	18,5	0.73	31,8	1.25
0616S	9,7	0.38	11/16-16	1 5/16-12	43,9	1.73	18,5	0.73	38,1	1.50
0806S	12,7	0.50	13/16-16	9/16-18	37,6	1.48	11,9	0.47	22,4	0.88
0808S	12,7	0.50	13/16-16	3/4-16	36,6	1.44	14,0	0.55	22,4	0.88
0810S	12,7	0.50	13/16-16	7/8-14	40,4	1.59	16,0	0.63	25,4	1.00
0812S	12,7	0.50	13/16-16	1 1/16-12	44,5	1.75	18,5	0.73	31,8	1.25
0814S	12,7	0.50	13/16-16	1 3/16-12	44,5	1.75	18,5	0.73	35,1	1.38
0816S	12,7	0.50	13/16-16	1 5/16-12	45,5	1.79	18,5	0.73	38,1	1.50
1008S	16,0	0.63	1-14	3/4-16	45,2	1.78	14,0	0.55	26,9	1.06
1010S	16,0	0.63	1-14	7/8-14	43,2	1.70	16,0	0.63	26,9	1.06
1012S	16,0	0.63	1-14	1 1/16-12	47,2	1.86	18,5	0.73	31,8	1.25
1206S	19,0	0.75	1 3/16-12	9/16-18	45,0	1.77	11,9	0.47	31,8	1.25
1208S	19,0	0.75	1 3/16-12	3/4-16	48,5	1.91	14,0	0.55	31,8	1.25
1210S	19,0	0.75	1 3/16-12	7/8-14	50,5	1.99	16,0	0.63	31,8	1.25
1212S	19,0	0.75	1 3/16-12	1 1/16-12	48,8	1.92	18,5	0.73	31,8	1.25
1214S	19,0	0.75	1 3/16-12	1 3/16-12	48,8	1.92	18,5	0.73	35,1	1.38
1216S	19,0	0.75	1 3/16-12	1 5/16-12	49,8	1.96	18,5	0.73	38,1	1.50
1608S	25,4	1.00	1 7/16-12	3/4-16	49,8	1.96	14,0	0.55	38,1	1.50
1610S	25,4	1.00	1 7/16-12	7/8-14	51,8	2.04	16,0	0.63	38,1	1.50
1612S	25,4	1.00	1 7/16-12	1 1/16-12	54,4	2.14	18,5	0.73	38,1	1.50
1614S	25,4	1.00	1 7/16-12	1 3/16-12	50,3	1.98	18,5	0.73	38,1	1.50
1616S	25,4	1.00	1 7/16-12	1 5/16-12	50,3	1.98	18,5	0.73	38,1	1.50
1620S	25,4	1.00	1 7/16-12	1 5/8-12	52,3	2.06	18,5	0.73	47,8	1.88
2016S	31,8	1.25	1 11/16-12	1 5/16-12	57,9	2.28	18,5	0.73	44,5	1.75
2020S	31,8	1.25	1 11/16-12	1 5/8-12	52,3	2.06	18,5	0.73	47,8	1.88
2024S	31,8	1.25	1 11/16-12	1 7/8-12	54,1	2.13	18,5	0.73	53,8	2.12
2420S	38,1	1.50	2-12	1 5/8-12	59,7	2.35	18,5	0.73	53,8	2.12
2424S	38,1	1.50	2-12	1 7/8-12	54,1	2.13	18,5	0.73	53,8	2.12

ORS/SAE O-Ring boss

ORS/SAE O-Ring boss adapter

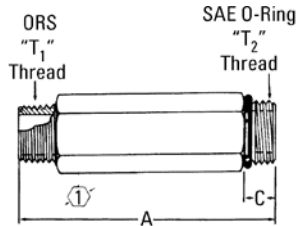

FF2211T(Dash size) (Ref. SAE 520122)

Dash size	Tube O. D.		Thread T1	Thread T2	A		C		①	
	mm	in			mm	in	mm	in	mm	in
0808S	12,7	0.50	13/16-16	3/4-16	68,1	2.68	14,0	0.55	22,3	0.88
1212S	19,0	0.75	1 3/16-12	1 1/16-12	72,9	2.87	18,5	0.73	31,8	1.25
1616S	25,4	1.00	1 7/16-12	1 5/16-12	104,5	4.11	18,5	0.73	38,1	1.50

ORS/SAE O-Ring boss long adapter

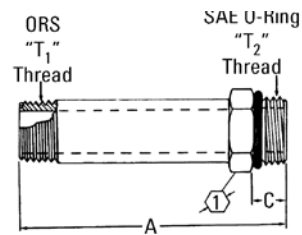

FF1854T(Dash size) (Ref. SAE 520122)
(Formerly Weatherhead Series 4316x)

Dash size	Tube O. D.		Thread T1	Thread T2	A		C		①	
	mm	in			mm	in	mm	in	mm	in
0404S	6,4	0.25	9/16-18	7/16-20	52,6	2.07	10,9	0.43	15,7	0.62
0606S	9,7	0.38	11/16-16	9/16-18	57,6	2.27	11,9	0.47	19,0	0.75
0808S	12,7	0.50	13/16-16	3/4-16	67,8	2.67	14,0	0.55	22,3	0.88
1010S	16,0	0.63	1-14	7/8-14	79,5	3.13	16,0	0.63	26,9	1.06
1212S	19,0	0.75	1 3/16-12	1 1/16-12	95,2	3.75	18,5	0.73	31,8	1.25
1616S	25,4	1.00	1 7/16-12	1 5/16-12	104,9	4.13	18,5	0.73	38,1	1.50
2020S	31,8	1.25	1 11/16-12	1 5/8-12	120,6	4.75	18,5	0.73	47,7	1.88
2424S	38,1	1.50	2-12	1 7/8-12	133,6	5.26	18,5	0.73	53,9	2.12

ORS female swivel/SAE O-Ring boss adapter

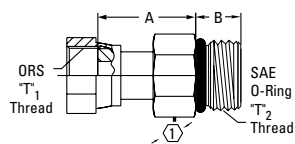

FF2130T(Dash size) (Ref. SAE 520181)

Dash size	Tube O. D.		Thread T1	Thread T2	A		B		①	
	mm	in			mm	in	mm	in	mm	in
0606S	9,7	0.38	11/16-16	9/16-18	28,2	1.11	11,9	0.47	17,5	0.69
0808S	12,7	0.50	13/16-16	3/4-16	35,3	1.39	14,0	0.55	22,3	0.88
1212S	19,0	0.75	1 3/16-12	1 1/16-12	41,1	1.62	18,5	0.73	31,8	1.25
1616S	25,4	1.00	1 7/16-12	1 5/16-12	49,0	1.93	18,5	0.73	38,1	1.50
2020S	31,8	1.25	1 11/16-12	1 5/8-12	47,2	1.86	18,5	0.73	47,7	1.88

Steel adapters

ORS/SAE O-Ring boss

ORS/SAE O-Ring boss

90° ORS/SAE O-Ring boss (adj.) adapter

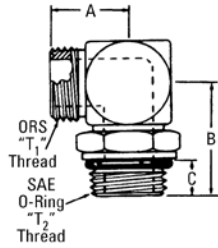

FF1868T(Dash size) (Ref. SAE 520220)
(Formerly Weatherhead Series 4515x)

Dash size	Tube O. D.		Thread T1	Thread T2	A		B		C	
	mm	in			mm	in	mm	in	mm	in
0403S	6,4	0.25	9/16-18	3/8-24	21,6	0.85	30,2	1.19	9,1	0.36
0404S	6,4	0.25	9/16-18	7/16-20	21,6	0.85	32,8	1.29	10,4	0.41
0405S	6,4	0.25	9/16-18	1/2-20	22,4	0.88	34,5	1.36	10,4	0.41
0406S	6,4	0.25	9/16-18	9/16-18	23,4	0.92	36,8	1.45	11,7	0.46
0408S	6,4	0.25	9/16-18	3/4-16	24,6	0.97	40,6	1.60	13,2	0.52
0604S	9,7	0.38	11/16-16	7/16-20	24,9	0.98	34,8	1.37	10,4	0.41
0605S	9,7	0.38	11/16-16	1/2-20	24,9	0.98	34,8	1.37	10,4	0.41
0606S	9,7	0.38	11/16-16	9/16-18	24,9	0.98	36,8	1.45	11,7	0.46
0608S	9,7	0.38	11/16-16	3/4-16	26,4	1.04	40,6	1.60	13,2	0.52
0610S	9,7	0.38	11/16-16	7/8-14	29,2	1.15	50,0	1.97	15,7	0.62
0612S	9,7	0.38	11/16-16	1 1/16-12	31,8	1.25	55,1	2.17	18,0	0.71
0806S	12,7	0.50	13/16-16	9/16-18	28,2	1.11	36,6	1.44	11,7	0.46
0808S	12,7	0.50	13/16-16	3/4-16	27,9	1.10	40,6	1.60	13,2	0.52
0810S	12,7	0.50	13/16-16	7/8-14	30,7	1.21	50,0	1.97	15,7	0.62
0812S	12,7	0.50	13/16-16	1 1/16-12	33,5	1.32	55,1	2.17	18,0	0.71
1008S	16,0	0.63	1-14	3/4-16	33,3	1.31	45,7	1.80	13,2	0.52
1010S	16,0	0.63	1-14	7/8-14	33,3	1.31	50,0	1.97	15,7	0.62
1012S	16,0	0.63	1-14	1 1/16-12	35,8	1.41	55,1	2.17	18,0	0.71
1208S	19,0	0.75	1 3/16-12	3/4-16	37,3	1.47	46,7	1.84	13,2	0.52
1210S	19,0	0.75	1 3/16-12	1 3/16-12	37,3	1.47	51,1	2.01	15,7	0.62
1212S	19,0	0.75	1 3/16-12	1 1/16-12	37,3	1.47	55,1	2.17	18,0	0.71
1214S	19,0	0.75	1 3/16-12	1 3/16-12	37,3	1.47	55,1	2.17	18,0	0.71
1216S	19,0	0.75	1 3/16-12	1 5/16-12	41,1	1.62	59,7	2.35	18,0	0.71
1612S	25,4	1.00	1 7/16-12	1 1/16-12	41,7	1.64	58,9	2.32	18,0	0.71
1614S	25,4	1.00	1 7/16-12	1 3/16-12	41,7	1.64	58,9	2.32	18,0	0.71
1616S	25,4	1.00	1 7/16-12	1 5/16-12	41,7	1.64	59,7	2.35	18,0	0.71
1620S	25,4	1.00	1 7/16-12	1 5/8-12	44,7	1.76	62,2	2.45	18,0	0.71
2012S	31,8	1.25	1 11/16-12	1 1/16-12	44,7	1.76	61,5	2.42	18,0	0.71
2016S	31,8	1.25	1 11/16-12	1 5/16-12	44,7	1.76	61,5	2.42	18,0	0.71
2020S	31,8	1.25	1 11/16-12	1 5/8-12	44,7	1.76	62,2	2.45	18,0	0.71
2420S	38,1	1.50	2-12	1 5/8-12	48,8	1.92	65,8	2.59	18,0	0.71
2424S	38,1	1.50	2-12	1 7/8-12	48,8	1.92	65,8	2.59	18,0	0.71

ORS/SAE O-Ring boss

90° ORS/SAE O-Ring boss (adj.) long adapter

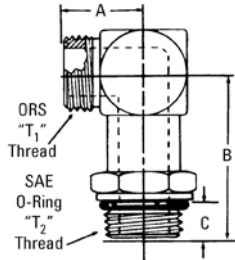

FF2227T(Dash size) (Ref. SAE 521520)
(Formerly Weatherhead Series 4515x-L)

Dash size	Tube O. D.		Thread T1	Thread T2	A		B		C	
	mm	in			mm	in	mm	in	mm	in
0404S	6,4	0.25	9/16-18	7/16-20	21,6	0.85	56,6	2.23	10,9	0.43
0606S	9,7	0.38	11/16-16	9/16-18	24,9	0.98	66,3	2.61	11,9	0.47
0808S	12,7	0.50	13/16-16	3/4-16	27,9	1.10	74,9	2.95	14,0	0.55
1010S	16,0	0.63	1-14	7/8-14	33,3	1.31	89,1	3.51	16,0	0.63
1212S	19,0	0.75	1 3/16-12	1 1/16-12	37,3	1.47	100,8	3.97	18,5	0.73
1616S	25,4	1.00	1 7/16-12	1 5/16-12	41,6	1.64	114,5	4.51	18,5	0.73
2020S	31,8	1.25	1 11/16-12	1 5/8-12	44,7	1.76	126,5	4.98	18,5	0.73

45° ORS/SAE O-Ring boss (adj.) adapter

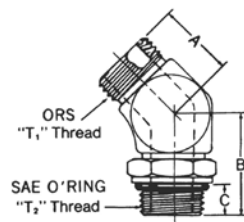

FF2068T(Dash size) (Ref. SAE 520320)
(Formerly Weatherhead Series 4365x)

Dash size	Tube O. D.		Thread T1	Thread T2	A		B		C	
	mm	in			mm	in	mm	in	mm	in
0404S	6,4	0.25	9/16-18	7/16-20	16,0	0.63	30,0	1.18	10,4	0.41
0406S	6,4	0.25	9/16-18	9/16-18	17,3	0.68	33,0	1.30	11,7	0.46
0408S	6,4	0.25	9/16-18	3/4-16	17,0	0.67	36,3	1.43	13,2	0.52
0604S	9,7	0.38	11/16-16	7/16-20	18,8	0.74	31,0	1.22	10,4	0.41
0606S	9,7	0.38	11/16-16	9/16-18	18,8	0.74	33,0	1.30	11,7	0.46
0608S	9,7	0.38	11/16-16	3/4-16	18,8	0.74	36,3	1.43	13,2	0.52
0806S	12,7	0.50	13/16-16	9/16-18	20,3	0.80	32,3	1.27	11,7	0.46
0808S	12,7	0.50	13/16-16	3/4-16	20,3	0.80	36,3	1.43	13,2	0.52
0810S	12,7	0.50	13/16-16	7/8-14	20,8	0.82	44,7	1.76	15,7	0.62
0816S	12,7	0.50	13/16-16	1 5/16-12	25,7	1.01	52,3	2.06	18,0	0.71
1008S	16,0	0.63	1-14	3/4-16	23,4	0.92	40,4	1.59	13,2	0.52
1010S	16,0	0.63	1-14	7/8-14	23,4	0.92	44,7	1.76	15,7	0.62
1012S	16,0	0.63	1-14	1 1/16-12	24,4	0.96	50,0	1.97	18,0	0.71
1210S	19,0	0.75	1 3/16-12	7/8-14	25,9	1.02	46,0	1.81	15,7	0.62
1212S	19,0	0.75	1 3/16-12	1 1/16-12	25,9	1.02	50,0	1.97	18,0	0.71
1216S	19,0	0.75	1 3/16-12	1 5/16-12	29,5	1.16	52,3	2.06	18,0	0.71
1612S	25,4	1.00	1 7/16-12	1 1/16-12	30,0	1.18	51,6	2.03	18,0	0.71
1616S	25,4	1.00	1 7/16-12	1 5/16-12	30,0	1.18	52,3	2.06	18,0	0.71
1620S	25,4	1.00	1 7/16-12	1 5/8-12	32,0	1.26	53,6	2.11	18,0	0.71
2020S	31,8	1.25	1 11/16-12	1 5/8-12	32,0	1.26	53,6	2.11	18,0	0.71
2424S	38,1	1.50	2-12	1 7/8-12	36,8	1.45	53,6	2.11	18,0	0.71

Steel adapters

ORS/SAE O-Ring boss

ORS/SAE O-Ring boss

ORS/ORS/SAE O-Ring boss (adj.) adapter

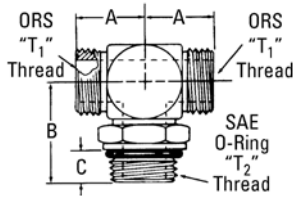

FF1861T(Dash size) (Ref. SAE 520429)
(Formerly Weatherhead Series 4715x)

Dash size	Tube O. D.		Thread T1	Thread T2	A		B		C	
	mm	in			mm	in	mm	in	mm	in
0404S	6,4	0.25	9/16-18	7/16-20	21,6	0.85	32,8	1.29	10,9	0.43
0606S	9,7	0.38	11/16-16	9/16-18	24,9	0.98	36,8	1.45	11,9	0.47
0608S	9,7	0.38	11/16-16	3/4-16	26,4	1.04	40,6	1.60	14,0	0.55
0806S	12,7	0.50	13/16-16	9/16-16	27,9	1.10	50,0	1.97	14,0	0.55
0808S	16,0	0.63	1-14	3/4-16	36,6	1.44	50,0	1.97	16,0	0.63
1010S	19,0	0.75	1 3/16-12	7/8-14	37,3	1.47	55,2	2.17	16,0	0.63
1210S	19,0	0.75	1 3/16-12	7/8-14	41,1	1.62	59,7	2.35	18,5	0.73
1212S	19,0	0.75	1 3/16-12	1 5/16-12	41,6	1.64	59,7	2.35	18,5	0.73
1216S	25,4	1.00	1 7/16-12	1 5/16-12	41,6	1.64	59,7	2.35	18,5	0.73
1616S	25,4	1.00	1 7/16-12	1 5/16-12	41,6	1.64	59,7	2.35	18,0	0.71
2020S	31,8	1.25	1 11/16-12	1 5/8-12	44,7	1.76	62,2	2.45	18,5	0.73

ORS/ORS/SAE O-Ring boss (adj.) adapter

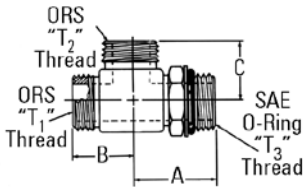

FF1865T(Dash size) (Ref. SAE 520428)
(Formerly Weatherhead Series 4716x)

Dash size	Tube O. D.		Thread T1	Thread T2	Thread T3	A		B		C	
	mm	in				mm	in	mm	in	mm	in
0404S	6,4	0.25	9/16-18	9/16-18	7/16-20	32,8	1.29	21,6	0.85	21,6	0.85
0406S	6,4	0.25	9/16-18	9/16-18	9/16-18	36,8	1.45	23,4	0.92	23,4	0.92
0604S	9,7	0.38	11/16-16	11/16-16	7/16-20	34,8	1.37	29,7	1.17	24,9	0.98
0606S	9,7	0.38	11/16-16	11/16-16	9/16-18	36,8	1.45	24,9	0.98	24,9	0.98
0806S	12,7	0.50	13/16-16	13/16-16	9/16-18	36,6	1.44	27,9	1.10	27,9	1.10
0808S	12,7	0.50	13/16-16	13/16-16	3/4-16	40,6	1.60	27,9	1.10	27,9	1.10
0812S	12,7	0.50	13/16-16	13/16-16	1 1/16-12	55,1	2.17	33,5	1.32	33,5	1.32
1010S	16,0	0.63	1-14	1-14	7/8-14	50,0	1.97	33,3	1.31	33,3	1.31
1012S	16,0	0.63	1-14	1-14	1 1/16-12	55,1	2.17	35,8	1.41	35,8	1.41
1212S	19,0	0.75	1 3/16-12	1 3/16-12	1 1/16-12	55,1	2.17	37,3	1.47	37,3	1.47
1220S	19,0	0.75	1 3/16-12	1 3/16-12	1 5/8-12	62,2	2.45	44,2	1.74	44,2	1.74
1616S	25,4	1.00	1 7/16-12	1 7/16-12	1 5/16-12	59,7	2.35	41,7	1.64	41,7	1.64
2020S	31,8	1.25	1 11/16-12	1 11/16-12	1 5/8-12	62,2	2.45	44,7	1.76	44,7	1.76
2424S	38,1	1.50	2-12	2-12	1 7/8-12	65,8	2.59	48,8	1.92	48,8	1.92

ORS/NPTF

ORS/male NPTF adapter

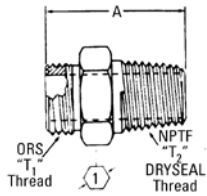

FF2031T(Dash size) (Ref. SAE 520102)
(Formerly Weatherhead Series 4205x)

Dash size	Tube O. D.		Thread T1	Thread T2	A		①	
	mm	in			mm	in	mm	in
0402S	6,4	0.25	9/16-18	1/8-27	26,2	1.03	15,7	0.62
0404S	6,4	0.25	9/16-18	1/4-18	31,5	1.24	15,7	0.62
0406S	6,4	0.25	9/16-18	3/8-18	31,5	1.24	19,1	0.75
0408S	6,4	0.25	9/16-18	1/2-14	37,8	1.49	22,4	0.88
0602S	9,7	0.38	11/16-16	1/8-27	28,4	1.12	19,1	0.75
0604S	9,7	0.38	11/16-16	1/4-18	33,0	1.30	19,1	0.75
0606S	9,7	0.38	11/16-16	3/8-18	33,0	1.30	19,1	0.75
0608S	9,7	0.38	11/16-16	1/2-14	39,4	1.55	22,4	0.88
0804S	12,7	0.50	13/16-16	1/4-18	34,5	1.36	22,4	0.88
0806S	12,7	0.50	13/16-16	3/8-18	34,5	1.36	22,4	0.88
0808S	12,7	0.50	13/16-16	1/2-14	40,9	1.61	22,4	0.88
0812S	12,7	0.50	13/16-16	3/4-14	42,7	1.68	26,9	1.06
1008S	16,0	0.63	1-14	1/2-14	43,7	1.72	26,9	1.06
1012S	16,0	0.63	1-14	3/4-14	45,2	1.78	26,9	1.06
1208S	19,0	0.75	1 3/16-12	1/2-14	46,7	1.84	31,8	1.25
1212S	19,0	0.75	1 3/16-12	3/4-14	46,7	1.84	31,8	1.25
1216S	19,0	0.75	1 3/16-12	1-11 1/2	51,6	2.03	35,1	1.38
1612S	25,4	1.00	1 7/16-12	3/4-14	47,2	1.86	38,1	1.50
1616S	25,4	1.00	1 7/16-12	1-11 1/2	52,1	2.05	38,1	1.50
1620S	25,4	1.00	1 7/16-12	1 1/4-11 1/2	54,9	2.16	42,9	1.69
2016S	31,8	1.25	1 11/16-12	1-11 1/2	54,1	2.13	44,5	1.75
2020S	31,8	1.25	1 11/16-12	1 1/4-11 1/2	54,9	2.16	44,5	1.75
2424S	38,1	1.50	2-12	1 1/2-11 1/2	57,4	2.26	53,8	2.12

45° ORS/male NPTF adapter

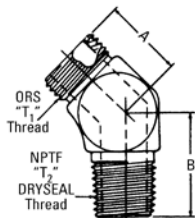

FF2093T(Dash size) (Ref. SAE 520302)
(Formerly Weatherhead Series 4355x)

Dash size	Tube O. D.		Thread T1	Thread T2	A		B	
	mm	in			mm	in	mm	in
0402S	6,4	0.25	9/16-18	1/8-27	16,0	0.63	17,3	0.68
0404S	6,4	0.25	9/16-18	1/4-18	17,3	0.68	23,6	0.93
0604S	9,7	0.38	11/16-16	1/4-18	18,8	0.74	23,6	0.93
0606S	9,7	0.38	11/16-16	3/8-18	18,8	0.74	26,4	1.04
0806S	12,7	0.50	13/16-16	3/8-18	20,3	0.80	26,4	1.04
0808S	12,7	0.50	13/16-16	1/2-14	20,8	0.82	30,5	1.20
1008S	16,0	0.63	1-14	1/2-14	23,4	0.92	30,5	1.20
1212S	19,0	0.75	1 3/16-12	3/4-14	25,9	1.02	31,2	1.23
1616S	25,4	1.00	1 7/16-12	1-11 1/2	30,0	1.18	38,3	1.51
2020S	31,8	1.25	1 11/16-12	1 1/4-11 1/2	32,0	1.26	42,9	1.69
2424S	38,1	1.50	2-12	1 1/2-11 1/2	36,8	1.45	45,7	1.80

Steel adapters

ORS/NPTF

ORS/NPTF

90° ORS/male NPTF adapter

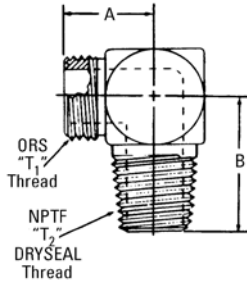

FF2032T(Dash size) (Ref. SAE 520202)
(Formerly Weatherhead Series 4405x)

Dash size	Tube O.D.		Thread T1	Thread T2	A		B	
	mm	in			mm	in	mm	in
0402S	6,4	0.25	9/16-18	1/8-27	21,6	0.85	21,3	0.84
0404S	6,4	0.25	9/16-18	1/4-18	23,4	0.92	29,2	1.15
0406S	6,4	0.25	9/16-18	3/8-18	24,4	0.96	31,8	1.25
0602S	9,7	0.38	11/16-16	1/8-27	24,9	0.98	24,4	0.96
0604S	9,7	0.38	11/16-16	1/4-18	24,9	0.98	29,2	1.15
0606S	9,7	0.38	11/16-16	3/8-18	26,4	1.04	31,8	1.25
0608S	9,7	0.38	11/16-16	1/2-14	29,2	1.15	38,9	1.53
0802S	12,7	0.50	13/16-16	1/8-27	27,9	1.10	22,1	0.87
0806S	12,7	0.50	13/16-16	3/8-18	27,9	1.10	31,8	1.25
0808S	12,7	0.50	13/16-16	1/2-14	30,7	1.21	38,9	1.53
0812S	12,7	0.50	13/16-16	3/4-14	33,5	1.32	41,9	1.65
1008S	16,0	0.63	1-14	1/2-14	33,3	1.31	38,9	1.53
1012S	16,0	0.63	1-14	3/4-14	35,8	1.41	41,9	1.65
1208S	19,0	0.75	1 3/16-12	1/2-14	37,3	1.47	41,9	1.65
1212S	19,0	0.75	1 3/16-12	3/4-14	37,3	1.47	41,9	1.65
1216S	19,0	0.75	1 3/16-12	1-11 1/2	41,1	1.62	51,6	2.03
1612S	25,4	1.00	1 7/16-12	3/4-14	41,7	1.64	46,7	1.84
1616S	25,4	1.00	1 7/16-12	1-11 1/2	41,7	1.64	51,6	2.03
2016S	31,8	1.25	1 11/16-12	1-11 1/2	44,7	1.76	60,5	2.38
2020S	31,8	1.25	1 11/16-12	1 1/4-11 1/2	44,7	1.76	61,2	2.41
2424S	38,1	1.50	2-12	1 1/2-11 1/2	48,8	1.92	68,6	2.70

ORS/ORS/male NPTF adapter

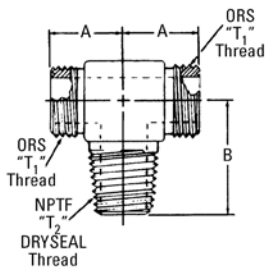

FF2001T(Dash size) (Ref. SAE 520425)

Dash size	Tube O. D.		Thread T1	Thread T2	A		B	
	mm	in			mm	in	mm	in
0404S	6,4	0.25	9/16-18	1/4-18	23,4	0.92	27,4	1.08
0604S	9,7	0.38	11/16-16	1/4-18	24,9	0.98	27,4	1.08
0606S	9,7	0.38	11/16-16	3/8-18	26,4	1.04	30,7	1.21
0806S	12,7	0.50	13/16-16	3/8-18	27,9	1.10	30,7	1.21
0808S	12,7	0.50	13/16-16	1/2-14	30,7	1.21	38,9	1.53
1212S	19,0	0.75	1 3/16-12	3/4-14	37,3	1.47	41,9	1.65
1616S	25,4	1.00	1 7/16-12	1-11 1/2	41,6	1.64	51,6	2.03

ORS to SAE 37° flare

ORS female swivel/SAE 37° male flare

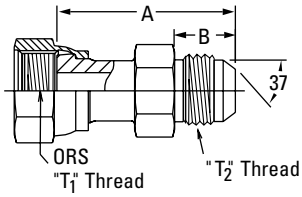

FF2209T(Dash size)
(Formerly Weatherhead Series 4213x)

Dash size	Tube O. D.		Thread T1	Thread T2	A		B	
	mm	in			mm	in	mm	in
0404S	6,4	0.25	9/16-18	7/16-20	38,1	1.50	14,0	1.55
0412S	6,4	0.25	9/16-18	1 1/16-12	50,5	1.99	21,8	0.86
0606S	9,7	0.38	11/16-16	9/16-18	41,4	1.62	14,2	0.56
0612S	9,7	0.38	11/16-16	1 1/16-12	52,6	2.07	21,8	0.86
0808S	12,7	0.50	13/16-16	3/4-16	51,6	2.03	16,8	0.66
0812S	12,7	0.50	13/16-16	1 1/16-12	57,2	2.25	21,8	0.86
1010S	16,0	0.63	1-14	7/8-14	53,6	2.11	19,3	0.76
1212S	19,0	0.75	1 3/16-12	1 1/16-12	62,0	2.44	21,8	0.86
1616S	25,4	1.00	1 7/16-12	1 5/16-12	71,6	2.82	23,1	0.91
2016S	31,8	1.25	1 11/16-12	1 5/16-12	73,1	2.88	23,1	0.91
2020S	31,8	1.35	1 11/16-12	1 5/8-12	76,7	3.02	24,3	0.96

Male ORS/SAE 37° male flare

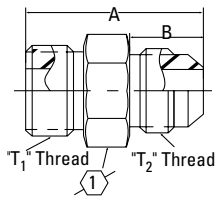

FF2313T(Dash size)

Dash size	Tube O. D.		Thread T1	Thread T2	A		B		①
	mm	in			mm	in	mm	in	
0808S	12,7	0.50	13/16-16	3/4-16	39,1	1.54	16,8	0.66	22,3 0.88

Everything you need to know about more than 200,000 products



eatonpowersource.com

Steel adapters

ORS/ORS

ORS/ORS

ORS/ORS adapter

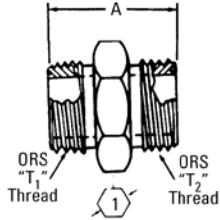

FF2000T(Dash size) (Ref. SAE 520101)
(Formerly Weatherhead Series 4305x)

Dash size	Tube O. D.		Thread T1	Thread T2	A		①	
	mm	in			mm	in	mm	in
0404S	6,4	0.25	9/16-18	9/16-18	27,4	1.08	15,7	0.62
0604S	9,7	0.38	11/16-16	9/16-18	29,7	1.17	19,0	0.75
0606S	9,7	0.38	11/16-16	11/16-16	31,0	1.22	19,0	0.75
0806S	12,7	0.50	13/16-16	11/16-16	33,8	1.33	22,3	0.88
0808S	12,7	0.50	13/16-16	13/16-16	35,3	1.39	22,3	0.88
1008S	16,0	0.63	1-14	13/16-16	39,9	1.57	26,9	1.06
1010S	16,0	0.63	1-14	1-14	42,7	1.68	26,9	1.06
1208S	19,0	0.75	1 3/16-12	13/16-16	42,9	1.69	31,8	1.25
1210S	19,0	0.75	1 3/16-12	1-14	45,7	1.80	31,8	1.25
1212S	19,0	0.75	1 3/16-12	1 3/16-12	47,2	1.86	31,8	1.25
1612S	25,4	1.00	1 7/16-12	1 3/16-12	48,8	1.92	38,1	1.50
1616S	25,4	1.00	1 7/16-12	1 7/16-12	49,3	1.94	38,1	1.50
2020S	31,8	1.25	1 11/16-12	1 11/16-12	51,3	2.02	44,4	1.75
2424S	38,1	1.50	2-12	2-12	53,1	2.09	53,9	2.12

ORS/ORS reducer adapter

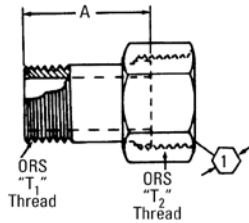

FF2281T(Dash size) (Ref. SAE 520123)

Dash size	Tube O. D.		Thread T1	Thread T2	A		①	
	mm	in			mm	in	mm	in
0406S	9,7	0.38	9/16-18	11/16-16	19,5	0.77	20,6	0.81
0408S†	12,7	0.50	9/16-18	13/16-16	21,8	0.86	23,9	0.94
0410S†	16,0	0.63	9/16-18	1-14	22,9	0.90	28,5	1.12
0412S†	19,0	0.75	9/16-18	1 3/16-12	24,9	0.98	35,1	1.38
0608S	12,7	0.50	11/16-16	13/16-16	22,3	0.88	23,9	0.94
0610S†	16,0	0.63	11/16-16	1-14	24,1	0.95	28,5	1.12
0612S†	19,0	0.75	11/16-16	1 3/16-12	26,2	1.03	35,1	1.38
0810S†	16,0	0.63	13/16-16	1-14	25,9	1.02	28,5	1.12
0812S†	19,0	0.75	13/16-16	1 3/16-12	27,9	1.10	35,1	1.38
0816S†	25,4	1.00	13/16-16	1 7/16-12	29,2	1.15	41,1	1.62
1012S	16,0	0.63	1 3/16-12	1-14	29,5	1.16	34,9	1.38
1216S	25,4	1.00	1 3/16-12	1 7/16-12	34,0	1.34	41,1	1.62
1220S†	31,8	1.25	1 3/16-12	1 11/16-12	33,5	1.32	47,7	1.88
1224S†	38,1	1.50	1 3/16-12	2-12	33,6	1.32	57,2	2.25
1620S	31,8	1.25	1 7/16-12	1 11/16-12	37,3	2.69	47,7	1.88
1624S†	38,1	1.50	1 7/16-12	2-12	34,0	1.34	57,2	2.25

† Available without nut. Order by part number FF2151T (Size).

ORS/ORS

ORS/ORS bulkhead adapter

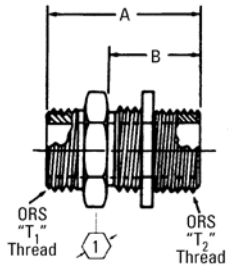

FF1994T(Dash size) (Ref. SAE 520601)
(Formerly Weatherhead Series 4325x)

Dash size	Tube O. D.		Thread T1	Thread T2	A		B		①
	mm	in			mm	in	mm	in	
0404S	6,4	0.25	9/16-18	9/16-18	48,3	1.90	31,5	1.24	20,6 0.81
0606S	9,7	0.38	11/16-16	11/16-16	53,1	2.09	34,0	1.34	25,4 1.00
0608S	9,7	0.38	11/16-16	13/16-16	56,9	2.24	36,6	1.44	28,4 1.12
0808S	12,7	0.50	13/16-16	13/16-16	58,4	2.30	36,6	1.44	28,4 1.12
1010S	16,0	0.63	1-14	1-14	66,5	2.62	40,6	1.60	33,3 1.31
1212S	19,0	0.75	1 3/16-12	1 3/16-12	69,1	2.72	41,7	1.64	38,1 1.50
1616S	25,4	1.00	1 7/16-12	1 7/16-12	70,1	2.76	42,2	1.66	44,5 1.75
2016S	31,8	1.25	1 11/16-12	1 7/16-12	70,1	2.76	42,2	1.66	44,5 1.75
2020S	31,8	1.25	1 11/16-12	1 11/16-12	70,1	2.76	42,2	1.66	50,8 2.00
2424S	38,1	1.50	2-12	2-12	70,1	2.76	42,2	1.66	60,5 2.38

Note: Available without nut. Order by Part no. FF1994H4-(dash size).

45° ORS/ORS female adapter

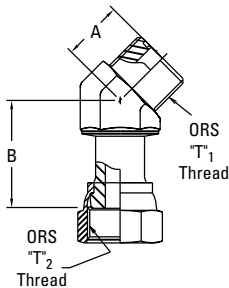

FF2133T(Dash size)

Dash size	Tube O. D.		Thread T1	Thread T2	A		B	
	mm	in			mm	in	mm	in
0606S	9,7	0.38	11/16-16	11/16-16	18,8	0.74	26,9	1.06
0808S	12,7	0.50	13/16-16	13/16-16	20,3	0.80	35,6	1.40
1010S	16,0	0.63	1-14	1-14	23,4	0.92	38,6	1.52
1212S	19,0	0.75	1 3/16-12	1 3/16-12	25,9	1.02	42,4	1.67
1616S	25,4	1.00	1 7/6-12	1 7/6-12	30,0	1.18	42,9	1.69

45° ORS/ORS bulkhead adapter

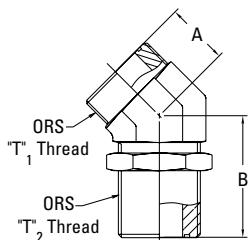

FF2144T(Dash size) (Ref. SAE 520801)

Dash size	Tube O. D.		Thread T1	Thread T2	A		B	
	mm	in			mm	in	mm	in
0404S	6,4	0.25	9/16-18	9/16-18	16,0	0.63	43,9	1.73
0606S	9,7	0.38	11/16-16	11/16-16	18,8	0.74	48,5	1.91
0808S	12,7	0.50	13/16-16	13/16-16	20,3	0.80	51,1	2.01
1212S	19,0	0.75	1 3/16-12	1 3/16-12	25,9	1.02	60,7	2.39
1616S	25,4	1.00	1 7/16-12	1 7/16-12	30,0	1.18	65,3	2.57

Note: Available without nut. Order by Part no. FF2144H4-(dash size).

90° ORS/ORS female adapter

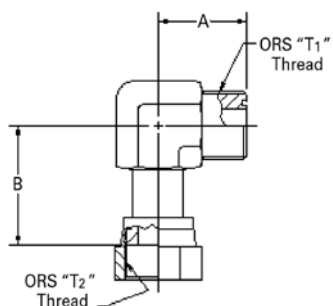

FF2098T(Dash size) (Ref. SAE 520221)
(Formerly Weatherhead Series 4506x)

Dash size	Tube O. D.		Thread T1	Thread T2	A		B	
	mm	in			mm	in	mm	in
0404S	6,4	0.25	9/16-18	9/16-18	21,6	0.85	26,4	1.04
0606S	9,7	0.38	11/16-16	11/16-16	24,9	0.98	29,2	1.15
0808S	12,7	0.50	13/16-16	13/16-16	27,9	1.10	37,8	1.49
1010S	16,0	0.63	1-14	1-14	33,3	1.31	41,1	1.62
1212S	19,0	0.75	1 3/16-12	1 3/16-12	37,3	1.47	46,2	1.82
1616S	25,4	1.00	1 7/16-12	1 7/16-12	41,7	1.64	53,3	2.10
2020S	31,8	1.25	1 11/16-12	1 11/16-12	44,7	1.76	58,2	2.29
2424S	38,1	1.50	2-12	2-12	48,8	1.92	61,2	2.41

Steel adapters

ORS/ORS

ORS/ORS

90° ORS/ORS adapter

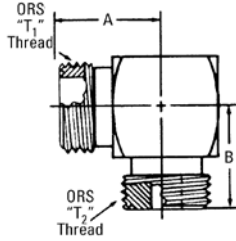

FF2035T(Dash size) (Ref. SAE 520201)
(Formerly Weatherhead Series 4505x)

Dash size	Tube O. D.		Thread T1	Thread T2	A		B	
	mm	in			mm	in	mm	in
0404S	6,4	0.25	9/16-18	9/16-18	21,6	0.85	21,6	0.85
0604S	9,7	0.38	11/16-16	9/16-18	24,9	0.98	23,4	0.92
0606S	9,7	0.38	11/16-16	11/16-16	24,9	0.98	24,9	0.98
0808S	12,7	0.50	13/16-16	13/16-16	27,9	1.10	27,9	1.10
1010S	16,0	0.63	1-14	1-14	33,3	1.31	33,3	1.31
1212S	19,0	0.75	1 3/16-12	1 3/16-12	37,3	1.47	37,3	1.47
1616S	25,4	1.00	1 7/16-12	1 7/16-12	41,6	1.64	41,6	1.64
2020S	31,8	1.25	1 11/16-12	1 11/16-12	44,7	1.76	44,7	1.76

90° ORS/ORS bulkhead adapter

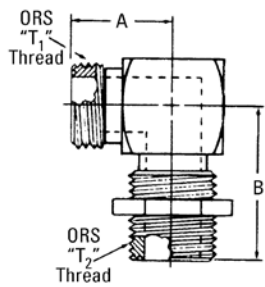

FF2030T(Dash size) (Ref. SAE 520701)
(Formerly Weatherhead Series 4525x)

Dash size	Tube O. D.		Thread T1	Thread T2	A		B		E	
	mm	in			mm	in	mm	in		
0404S	6,4	0.25	9/16-18	9/16-18	22,6	0.89	47,0	1.85	4,3	0.17
0606S	9,7	0.38	11/16-16	11/16-16	25,9	1.02	52,1	2.05	6,6	0.26
0806S	12,7	0.50	13/16-16	11/16-16	29,0	1.14	53,8	2.12	6,6	0.26
0808S	12,7	0.50	13/16-16	13/16-16	29,0	1.14	55,4	2.18	9,7	0.38
1010S	16,0	0.63	1-14	1-14	34,5	1.36	63,0	2.48	12,2	0.48
1212S	19,0	0.75	1 3/16-12	1 3/16-12	38,6	1.52	67,3	2.65	15,5	0.61
1616S	25,4	1.00	1 7/16-12	1 7/16-12	42,4	1.67	71,1	2.80	20,6	0.81
2020S	31,8	1.25	1 11/16-12	1 11/16-12	45,5	1.79	75,4	2.97	26,2	1.03

Note: Available without nut. Order by Part no. FF2030H4-(dash size).

ORS/ORS/ORS

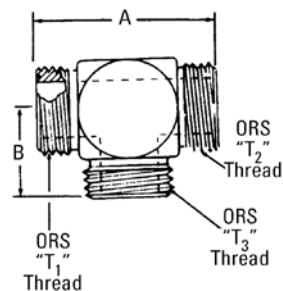

FF1898T(Dash size) (Ref. SAE 520401)
(Formerly Weatherhead Series 4705x)

Dash size	Tube O. D.		Thread T1	Thread T2	Thread T3	A		B	
	mm	in				mm	in	mm	in
0404S	6,4	0.25	9/16-18	9/16-18	9/16-18	43,2	1.70	21,6	0.85
0606S	9,7	0.38	11/16-16	11/16-16	11/16-16	49,8	1.96	24,9	0.98
0608S	9,7	0.38	11/16-16	11/16-16	13/16-16	52,8	2.08	27,9	1.10
0808S	12,7	0.50	13/16-16	13/16-16	13/16-16	55,9	2.20	27,9	1.10
1010S	16,0	0.63	1-14	1-14	1-14	66,5	2.62	33,3	1.31
1212S	19,0	0.75	1 3/16-12	1 3/16-12	1 3/16-12	74,7	2.94	37,3	1.47
1216S	19,0	0.75	1 3/16-12	1 3/16-12	1 7/16-12	82,3	3.24	44,7	1.76
1616S	25,4	1.00	1 7/16-12	1 7/16-12	1 7/16-12	83,3	3.28	41,6	1.64
2016S	31,8	1.25	1 11/16-12	1 11/16-12	1 7/16-12	89,4	3.52	44,7	1.76
2020S	31,8	1.25	1 11/16-12	1 11/16-12	1 11/16-12	89,4	3.52	44,7	1.76
2424S	38,1	1.50	2-12	2-12	2-12	97,5	3.84	48,8	1.92

ORS/ORS

ORS - bulkhead run tee

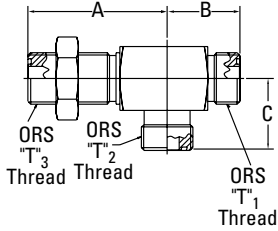

FF2174T(Dash size) (Ref. SAE 520958)
(Formerly Weatherhead Series 4726x)

Dash size	Tube O. D.		Thread T1	Thread T2	Thread T3	A		B		C	
	mm	in				mm	in	mm	in	mm	in
0404S	6,4	0.25	9/16-18	9/16-18	9/16-18	47,0	1.85	22,6	0.89	22,6	0.89
0606S	9,7	0.38	11/16-16	11/16-16	11/16-16	52,0	2.05	25,9	1.02	25,7	1.01
0808S	12,7	0.50	13/16-16	13/16-16	13/16-16	55,4	2.18	29,0	1.14	28,7	1.13
1212S	19,0	0.75	1 3/16-12	1 3/16-12	1 3/16-12	54,9	2.16	40,6	1.60	40,6	1.60
1616S	25,4	1.00	1 7/16-12	1 7/16-12	1 7/16-12	71,1	2.80	42,4	1.67	42,4	1.67
2020S	31,8	1.25	1 11/16-12	1 11/16-12	1 11/16-12	71,1	2.80	48,8	1.92	48,8	1.92

ORS/ORS/ORS female adapter

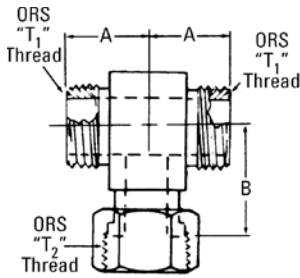

FF1857T(Dash size) (Ref. SAE 520433)
(Formerly Weatherhead Series 4707x)

Dash size	Tube O. D.		Thread T1	Thread T2	A		B	
	mm	in			mm	in	mm	in
0404S	6,4	0.25	9/16-18	9/16-18	21,6	0.85	26,4	1.04
0606S	9,7	0.38	11/16-16	11/16-16	24,9	0.98	29,2	1.15
0808S	12,7	0.50	13/16-16	13/16-16	27,9	1.10	37,8	1.49
1010S	16,0	0.63	1-14	1-14	33,3	1.31	41,1	1.62
1212S	19,0	0.75	1 3/16-12	1 3/16-12	37,3	1.47	46,2	1.82
1616S	25,4	1.00	1 7/16-12	1 7/16-12	41,6	1.64	53,3	2.10
2020S	31,8	1.25	1 11/16-12	1 11/16-12	44,7	1.76	58,2	2.29

ORS/ORS female/ORS adapter

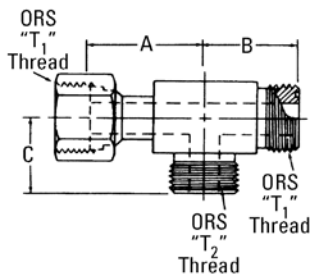

FF2114T(Dash size) (Ref. SAE 520432)
(Formerly Weatherhead Series 4706x)

Dash size	Tube O. D.		Thread T1	Thread T2	A		B		C	
	mm	in			mm	in	mm	in	mm	in
0404S	6,4	0.25	9/16-18	9/16-18	26,4	1.04	21,6	0.85	21,6	0.85
0606S	9,7	0.38	11/16-16	11/16-16	29,2	1.15	24,9	0.98	24,9	0.98
0808S	12,7	0.50	13/16-16	13/16-16	37,8	1.49	27,9	1.10	27,9	1.10
1010S	16,0	0.63	1-14	1-14	41,1	1.62	33,3	1.31	33,3	1.31
1212S	19,0	0.75	1 3/16-12	1 3/16-12	46,2	1.82	37,3	1.47	37,3	1.47
1616S	25,4	1.00	1 7/16-12	1 7/16-12	53,3	2.10	41,7	1.64	41,7	1.64
2020S	31,8	1.25	1 11/16-12	1 11/16-12	58,2	2.29	44,7	1.76	44,7	1.76
2424S	38,1	1.50	2-12	2-12	61,2	2.41	48,8	1.92	48,8	1.92

ORS/ORS/ORS bulkhead adapter

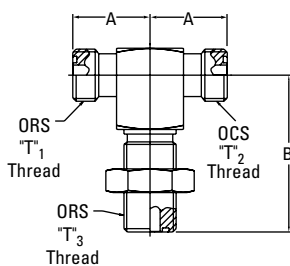

FF2033T(Dash size) (Ref. SAE 520959)

Dash size	Tube O. D.		Thread T1	Thread T2	Thread T3	A		B	
	mm	in				mm	in	mm	in
0606S	9,7	0.38	11/16-16	11/16-16	11/16-16	25,7	1.01	52,0	2.05
0808S	12,7	0.50	13/16-16	13/16-16	13/16-16	28,7	1.13	55,4	2.18
1212S	19,0	0.75	1 3/16-12	1 3/16-12	1 3/16-12	40,6	1.60	67,3	2.65
1616S	25,4	1.00	1 7/16-12	1 7/16-12	1 7/16-12	42,4	1.67	71,1	2.80

Steel adapters

ORS accessories

ORS accessories

ORS Bulkhead nut

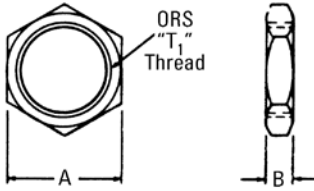

FF9768-(Dash size) (Ref. SAE 520118)
(Formerly Weatherhead Series 4924x)

Dash size	Tube O. D.		Thread T1	A		B	
	mm	in		mm	in	mm	in
04S	6,4	0.25	9/16-18	20,6	0.81	6,8	0.27
06S	9,7	0.38	11/16-16	25,4	1.00	7,9	0.31
08S	12,7	0.50	13/16-16	28,5	1.12	8,9	0.35
10S	16,0	0.63	1-14	33,3	1.31	10,4	0.41
12S	19,0	0.75	1 3/16-12	38,1	1.50	10,4	0.41
16S	25,4	1.00	1 7/16-12	44,4	1.75	10,4	0.41
20S	31,8	1.25	1 11/16-12	50,8	2.00	10,4	0.41
24S	38,1	1.50	2-12	60,4	2.38	10,4	0.41

ORS plug

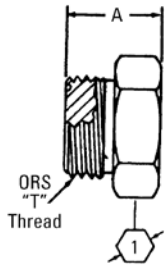

FF9767T-(Dash size) (Ref. SAE 520109)
(Formerly Weatherhead Series 4229x)

Dash size	Tube O. D.		Thread T1	A		1	
	mm	in		mm	in	mm	in
04-S	6,4	0.25	9/16-18	16,8	0.66	15,7	0.62
06-S	9,7	0.38	11/16-16	19,1	0.75	19,1	0.75
08-S	12,7	0.50	13/16-16	22,1	0.87	22,4	0.88
10-S	16,0	0.63	1-14	25,9	1.02	26,9	1.06
12-S	19,0	0.75	1 3/16-12	27,4	1.08	31,8	1.25
16-S	25,4	1.00	1 7/16-12	27,9	1.10	38,1	1.50
20-S	31,8	1.25	1 11/16-12	27,9	1.10	44,5	1.75
24-S	38,1	1.50	2-12	27,9	1.10	53,8	2.12

ORS cap assembly

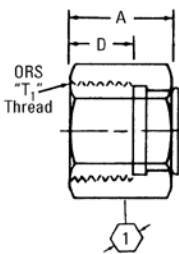

FF9863-(Dash size) (Ref. SAE 520112)
(Formerly Weatherhead Series 4129x)

Dash size	Tube O. D.		Thread T1	A		D		1	
	mm	in		mm	in	mm	in	mm	in
04S	6,4	0.25	9/16-18	16,8	0.66	8,1	0.32	17,5	0.69
06S	9,7	0.38	11/16-16	19,1	0.75	9,7	0.38	20,6	0.81
08S	12,7	0.50	13/16-16	22,9	0.90	10,9	0.43	23,9	0.94
10S	16,0	0.63	1-14	25,4	1.00	13,5	0.53	28,4	1.12
12S	19,0	0.75	1 3/16-12	27,9	1.10	14,5	0.57	35,1	1.38
16S	25,4	1.00	1 7/16-12	29,7	1.17	14,7	0.58	41,1	1.62
20S	31,8	1.25	1 11/16-12	29,7	1.17	14,7	0.58	47,8	1.88
24S	38,1	1.50	2-12	29,7	1.17	14,7	0.58	57,2	2.25

ORS accessories

ORS cap (use with FC2326 nut)

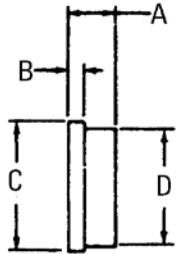

FF9766-(Dash size)

Dash size	Tube O. D.		A		B		C		D	
	mm	in	mm	in	mm	in	mm	in	mm	in
04S	6,4	0.25	8,6	0.34	4,1	0.16	12,7	0.50	10,2	0.40
06S	9,7	0.38	9,4	0.37	4,6	0.18	15,7	0.62	13,2	0.52
08S	12,7	0.50	11,9	0.47	5,1	0.20	18,8	0.74	16,2	0.64
10S	16,0	0.63	11,9	0.47	6,1	0.24	23,4	0.92	20,8	0.82
12S	19,0	0.75	13,5	0.53	6,6	0.26	27,7	1.09	23,9	0.94
16S	25,4	1.00	15,0	0.59	7,1	0.28	34,0	1.34	28,7	1.13
20S	31,8	1.25	15,0	0.59	7,1	0.28	40,4	1.59	35,6	1.40
24S	38,1	1.50	15,0	0.59	7,1	0.28	48,5	1.91	43,4	1.71

ORS silver braze ring

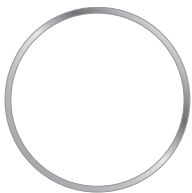

FF9075-(Dash size)

Dash size	Tube O. D.	
	mm	in
19	6,4	0.25
06	9,7	0.38
74	12,7	0.50
08	16,0	0.63
09	19,0	0.75
86	25,4	1.00
87	31,8	1.25
88	38,1	1.50

FIND IT QUICKLY

Want an easy way to find the new Eaton adapter part number?

Just go to **PowerSource Cross Reference** tool and type in the previous adapter part number here.

eatonpowersource.com

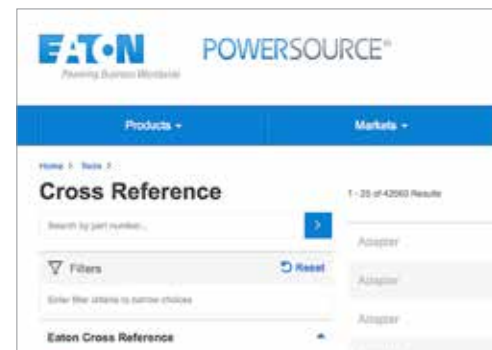

Steel adapters

SAE O-Ring boss/SAE O-Ring boss

SAE O-Ring boss/SAE O-Ring boss

SAE O-Ring boss reducer

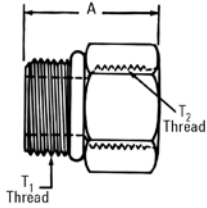

FF1010-(Dash size)
(Formerly Weatherhead Series 7033x)

Dash size	Threads T1	Threads T2	A	
			mm	in
0304S	3/8-24	7/16-20	24,4	0.96
0406S	7/16-20	9/16-18	27,2	1.07
0408S	7/16-20	3/4-16	32,0	1.26
0604S	9/16-18	7/16-20	24,4	0.96
0806S	3/4-16	9/16-18	26,9	1.06
1006S	7/8-14	9/16-18	20,6	0.81
1008S	7/8-14	3/4-16	31,8	1.25
1206S	1 1/16-12	9/16-18	25,4	1.00
1208S	1 1/16-12	3/4-16	25,4	1.00
1210S	1 1/16-12	7/8-14	36,6	1.44
1216S	1 1/16-12	1 5/16-12	45,5	1.79
1412S	1 3/16-12	1 1/16-12	43,7	1.72
1608S	1 5/16-12	3/4-16	25,4	1.00
1610S	1 5/16-12	7/8-14	36,6	1.44
1612S	1 5/16-12	1 1/16-12	40,4	1.59
2012S	1 5/8-12	1 1/16-12	25,4	1.00
2016S	1 5/8-12	1 5/16-12	25,4	1.00
2412S	1 7/8-12	1 1/16-12	39,6	1.56
2416S	1 7/8-12	1 5/16-12	25,4	1.00
2420S	1 7/8-12	1 5/8-12	39,6	1.56

Note: Available without O-Ring, Order FF1009-(dash size)

O-Ring boss plug

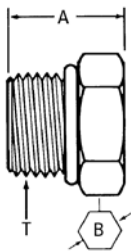

900598-(Dash size) (Ref. SAE 090109A)
(Formerly Weatherhead Series 7237x)

Dash size	Threads T1	A		B	
		mm	in	mm	in
4S	7/16-20	17,0	0.67	14,2	0.56
5S	1/2-20	17,0	0.67	15,7	0.62
6S	9/16-18	18,5	0.73	17,5	0.69
8S	3/4-16	20,3	0.80	22,4	0.88
10S	7/8-14	23,6	0.93	25,4	1.00
12S	1 1/16-12	27,7	1.09	31,8	1.25
14S	1 3/16-12	27,7	1.09	35,1	1.38
16S	1 5/16-12	28,4	1.12	38,1	1.50
20S	1 5/8-12	30,5	1.20	47,8	1.88
24S	1 7/8-12	32,3	1.27	53,8	2.12
32S	2 1/2-12	36,3	1.43	69,9	2.75
2S	5/16-24	15,2	0.60	11,2	0.44
3S	3/8-24	15,2	0.60	12,7	0.50

Note: Available without O-Ring. Order as 900598-1-(dash size).
(Formerly Weatherhead Series B7237x)

SAE O-Ring boss/SAE O-Ring boss

SAE Male O-Ring boss (Hex socket)

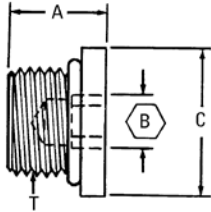

FF2138-(Dash size) (Ref. SAE 090109B)
(Formerly Weatherhead Series 7238x)

Dash size	Tube O.D.		Threads T1	A		C (Round)		Hex	
	mm	in		mm	in	mm	in	mm	in
02S	3,3	0.13	5/16-24	10,2	0.40	11,2	0.44	3,3	0.13
03S	4,8	0.19	3/8-24	10,2	0.40	12,7	0.50	4,0	0.16
04S	6,3	0.25	7/16-20	11,9	0.47	14,3	0.56	4,8	0.19
05S	7,9	0.31	1/2-20	11,9	0.47	16,0	0.63	5,6	0.22
06S	9,6	0.38	9/16-18	12,8	0.50	17,5	0.69	6,4	0.25
08S	12,7	0.5	3/4-16	14,7	0.58	22,3	0.88	8,0	0.32
10S	16,0	0.63	7/8-14	16,5	0.65	25,4	1.00	9,6	0.38
12S	19,0	0.75	1 1/16-12	19,6	0.77	31,8	1.25	14,4	0.57
14S	22,2	0.88	1 3/16-12	19,6	0.77	35,0	1.38	14,4	0.57
16S	25,4	1.00	1 5/16-12	19,6	0.77	38,1	1.50	16,0	0.63
20S	31,8	1.25	1 5/8-12	19,6	0.77	47,8	1.88	19,1	0.75

Note: Available without O-Ring. Order as FF2137-(dash size)
(Formerly Weatherhead series B7238x)

SAE O-Ring boss/adjustable SAE O-Ring boss

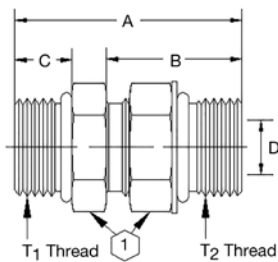

2220-(Dash size)
(Formerly Weatherhead Series C5314x)

Dash size	Threads T1	A		B		D Hole		E Hex		F Hex	
		mm	in	mm	in	mm	in	mm	in	mm	in
4-4S	7/16-20	34,8	1.37	9,1	0.38	4,3	0.17	14,3	0.56	14,3	0.56
6-6S	9/16-18	37,8	1.49	9,9	0.39	7,6	0.30	17,5	0.69	17,5	0.69
8-8S	3/4-16	44,4	1.75	11,1	0.44	9,9	0.39	22,2	0.88	22,2	0.88
10-10S	7/8-14	51,8	2.04	12,7	0.50	12,2	0.48	25,4	1.00	25,4	1.00
12-12S	1 1/16-12	54,1	2.13	15,0	0.59	15,5	0.61	31,8	1.25	31,8	1.25
16-16S	1 5/16-12	59,9	2.36	15,0	0.59	21,3	0.84	38,1	1.50	38,1	1.50
20-20S	1 5/8-12	58,9	2.32	15,0	0.59	27,4	1.08	47,6	1.88	47,6	1.88
24-24S	1 7/8-12	63,0	2.48	15,0	0.59	33,3	1.32	54,0	2.13	54,0	2.13

SAE Male O-Ring boss/ NPTF external pipe

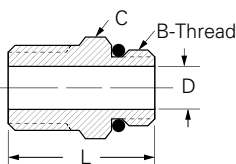
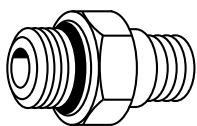

FF1796-(Dash size)
(Formerly Weatherhead Series C3249x)

Dash size	Port size	Male pipe thread	Straight thread B	Hex C		D		L	
				mm	in	mm	in	mm	in
0402S	1/4	1/8	7/16-20	14,3	9/16	4.4	.172	26.7	1.05
0604S	3/8	1/4	9/16-18	17,5	11/16	7.1	.281	33.0	1.30
0806S	1/2	3/8	3/4-16	22,2	7/8	9.9	.391	34.5	1.36
0808S	1/2	1/2	3/4-16	22,2	7/8	9.9	.391	39.4	1.55
1008S	5/8	1/2	7/8-14	25,4	1	12.3	.484	42.9	1.69
1212S	3/4	3/4	1 1/16-12	31,8	1 1/4	15.5	.609	43.9	1.73
1616S	1	1	1 5/16-12	38,1	1 1/2	21.4	.844	52.3	2.06
2020S	1 1/4	1 1/4	1 5/8-12	47,6	1 7/8	27.4	1.078	55.1	2.17
2424S	1 1/2	1 1/2	1 7/8-12	54,0	2 1/8	33.3	1.312	57.4	2.26
3232S	2	2	2 1/2-12	70,0	2 3/4	45.2	1.781	62.7	2.47

Replacement O-Ring on page 112.

Steel adapters

SAE O-Ring boss/SAE O-Ring boss

SAE O-Ring boss/SAE O-Ring boss

Male SAE O-Ring boss/male SAE O-Ring boss

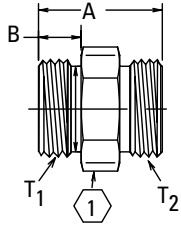

2229-(Dash size)

Dash size	Tube O.D.		Threads T1	Thread T2	A		B		①
	mm	in			mm	in	mm	in	
8-8S	12,7	0.50	3/4-16	3/4-16	30,3	1.19	11,2	0.44	22,3 0.88
16-16S	25,4	1.00	1 5/16-12	1 5/16-12	43,9	1.73	15,0	0.59	38,1 1.50

90° female SAE O-Ring boss/adjustable SAE O-Ring boss male

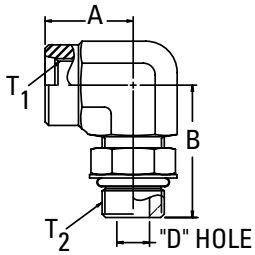

FF2591-(Dash size)

Dash size	Tube O.D.		Threads T1	Thread T2	A		B	
	mm	in			mm	in	mm	in
0404S	6,4	0.25	7/16-20	7/16-20	21,6	0.85	32,0	1.26

SAE O-Ring boss (adj.)/hose connector

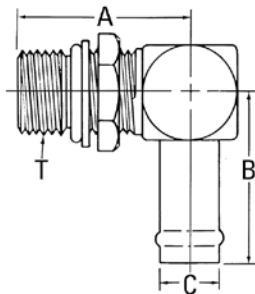

FF1167-(Dash size)

Dash size	Tube O.D.		Threads T1	A		B		C	
	mm	in		mm	in	mm	in	mm	in
1212S	19,0	0.75	1 1/16-12	49,8	1.96	52,3	2.06	19,0	0.75

Note: Available without O-Ring - order by FF1161-(dash size).
Clamp required.

Pipe to pipe

NPTE external pipe/ NPTF external pipe

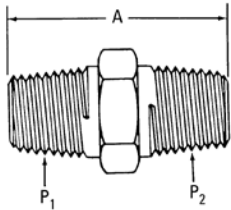

2083-(Dash size) (Ref. SAE 140137)
(Formerly Weatherhead series C3069x)

Dash size	Threads P1	Thread P2	A	
			mm	in
1-1S	1/16-27	1/16-27	23,9	0.94
2-1S	1/8-27	1/16-27	24,6	0.97
2-2S*	1/8-27	1/8-27	26,9	1.06
4-2S*	1/4-18	1/8-27	32,0	1.26
4-4S*	1/4-18	1/4-18	36,8	1.45
6-2S	3/8-18	1/8-27	31,8	1.25
6-4S*	3/8-18	1/4-18	36,8	1.45
6-6S*	3/8-18	3/8-18	36,8	1.45
8-4S	1/2-14	1/4-18	43,2	1.70
8-6S	1/2-14	3/8-18	43,2	1.70
8-8S*	1/2-14	1/2-14	48,0	1.89
12-6S	3/4-14	3/8-18	45,0	1.77
12-8S	3/4-14	1/2-14	49,8	1.96
12-12S*	3/4-14	3/4-14	49,8	1.96
16-12S	1-11 1/2	3/4-14	54,6	2.15
16-16S*	1-11 1/2	1-11 1/2	59,4	2.34
20-16S	1 1/4-11 1/2	1-11 1/2	62,2	2.45
20-20S*	1 1/4-11 1/2	1 1/4-11 1/2	63,0	2.48
24-24S*	1 1/2-11 1/2	1 1/2-11 1/2	66,3	2.61
32-32S	2-11 1/2	2-11 1/2	71,6	2.82

* Also available in stainless steel as part number 259-2083-(dash size)
(formerly Weatherhead 3081x).

NPTF external pipe/NPSM external pipe

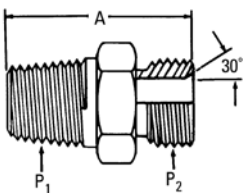

2015-(Dash size)

Dash size	Threads P1	Thread P2	A	
			mm	in
8-8S	1/2-14	1/2-14	38,1	1.50
12-12S	3/4-14	3/4-14	41,1	1.62
16-16S	1-11 1/2	1-11 1/2	48,5	1.91
24-24S	1 1/2-11 1/2	1 1/2-11 1/2	54,4	2.14

Steel adapters

Pipe to pipe

Pipe to pipe

NPTF bulkhead coupling

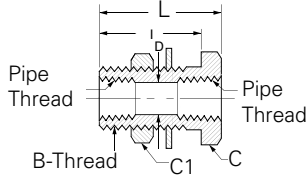
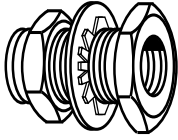

FF4183-(Dash size)
(Formerly Weatherhead Series W)

Dash size	Female pipe thread	Thread Size B	Hex C		Hex C1		D		I		L	
			mm	in	mm	in	mm	in	mm	in	mm	in
-0404-1S	1/4	3/4-16	25,4	1	26,9	1-1/16	10,7	.422	31,8	1,25	38,1	1,50
-0404-2S	1/4	3/4-16	25,4	1	26,9	1-1/16	10,7	.422	17,5	.69	23,9	.94
-0606S	3/8	1-14	28,6	1-1/8	34,9	1-3/8	14,3	.563	26,9	1,06	33,3	1,31

NPTF bulkhead coupling

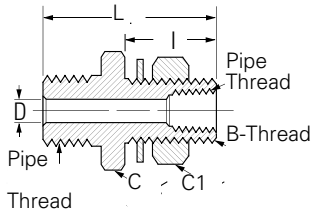
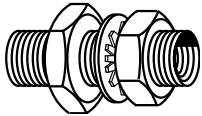

FF4185-(Dash size)
(Formerly Weatherhead Series W)

Dash size	Male pipe thread	Female pipe thread	Thread Size B	Hex C		Hex C1		D		I		L	
				mm	in	mm	in	mm	in	mm	in	mm	in
-0804-1S	1/2	1/4	3/4-16	31,8	1-1/4	26,9	1-1/16	7,9	.312	28,7	1,13	54,8	2,16
-0804-2S	1/2	1/4	3/4-16	31,8	1-1/4	26,9	1-1/16	7,9	.312	38,8	1,53	64,2	2,53

NPTF bulkhead coupling

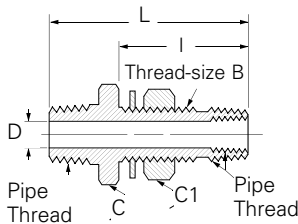
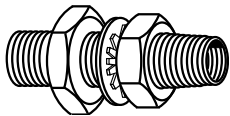

FF4186-(Dash size)
(Formerly Weatherhead Series W)

Dash size	Male pipe thread	Female pipe thread	Thread Size B	Hex C		Hex C1		D		I		L	
				mm	in	mm	in	mm	in	mm	in	mm	in
-0804-1S	1/2	1/4	1-14	31,8	1-1/4	34,9	1-3/8	9,5	.375	47,6	1,88	74,7	2,94
-0804-2S	1/2	1/4	1-14	31,8	1-1/4	34,9	1-3/8	9,5	.375	73,2	2,88	100,0	3,94

Pipe to pipe

NPTF external pipe/ NPTF external pipe

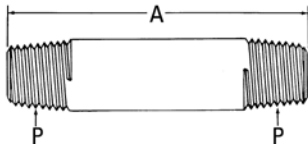

2084-(Dash size)

Dash size	Threads T1	A	
		mm	in
2S-3/4	1/8-27	19,0	0.75
2S-2	1/8-27	50,8	2.00
4S-7/8	1/4-18	22,3	0.88
4S-2	1/4-18	50,8	2.00
4S-3	1/4-18	76,2	3.00
4S-4	1/4-18	101,6	4.00
6S-1	3/8-18	25,4	1.00
6S-2	3/8-18	50,8	2.00
6S-3	3/8-18	76,2	3.00
6S-4	3/8-18	101,6	4.00
6S-6	3/8-18	152,4	6.00
8S-1 1/8	1/2-14	28,5	1.12
8S-2 1/2	1/2-14	63,5	2.50
12S-1 3/8	3/4-14	35,1	1.38
16S-1 1/2	1-11 1/2	38,1	1.50
20S-1 5/8	1 1/4-11 1/2	41,1	1.62
24S-1 3/4	1 1/2-11 1/2	44,4	1.75

NPTF reducer-external pipe/ NPTF internal pipe

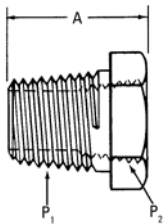
2081-(Dash size) (Ref. SAE 140140)
(Formerly Weatherhead series C3109x)

Dash size	Thread P1	Thread P2	A	
			mm	in
4-2S*	1/4-18	1/8-27	21,6	0.85
6-2S*	3/8-18	1/8-27	21,6	0.85
6-4S*	3/8-18	1/4-18	25,4	1.00
8-2S	1/2-14	1/8-27	27,9	1.10
8-4S*	1/2-14	1/4-18	27,9	1.10
8-6S*	1/2-14	3/8-18	28,4	1.12
12-4S*	3/4-14	1/4-18	29,7	1.17
12-6S	3/4-14	3/8-18	29,7	1.17
12-8S	3/4-14	1/2-14	34,5	1.36
16-4S	1-11 1/2	1/4-18	34,5	1.36
16-6S	1-11 1/2	3/8-14	34,5	1.36
16-8S*	1-11 1/2	1/2-14	34,5	1.36
16-12S*	1-11 1/2	3/4-14	37,8	1.49
20-8S	1 1/4-11 1/2	1/2-14	37,3	1.47
20-12S*	1 1/4-11 1/2	3/4-14	37,3	1.47
20-16S*	1 1/4-11 1/2	1-11 1/2	40,9	1.61
24-12S	1 1/2-11 1/2	3/4-14	39,9	1.57
24-16S	1 1/2-11 1/2	1-11 1/2	39,9	1.57
24-20S	1 1/2-11 1/2	1 1/4-11 1/2	39,9	1.57
32-16S*	2-11 1/2	1-11 1/2	44,5	1.75
32-20S*	2-11 1/2	1 1/4-11 1/2	44,5	1.75
32-24S	2-11 1/2	1 1/2-11 1/2	44,5	1.75

* Also available in stainless steel as part number 259-2081-(dash size)
(formerly Weatherhead 3121x)

Steel adapters

Pipe to pipe

Pipe to pipe

NPTF external pipe/Plug

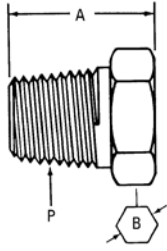

2082-(Dash size) (Ref. SAE 140109E)
(Formerly Weatherhead series C3159x)

Dash size	Threads P1	A		B	
		mm	in	mm	in
2S*	1/8-27	14,7	0.58	11,2	0.44
4S*	1/4-18	19,3	0.76	14,2	0.56
6S*	3/8-18	20,1	0.79	22,3	0.69
8S	1/2-14	24,9	0.98	22,4	0.88
12S	3/4-14	27,4	1.08	26,9	1.06
16S	1-11 1/2	32,3	1.27	44,4	1.31
20S	1 1/4-11 1/2	33,0	1.30	44,5	1.75
24S	1 1/2-11 1/2	33,8	1.33	50,8	2.00
32S	2-11 1/2	35,3	1.39	60,5	2.38

* Also available in stainless steel as part number 259-2082-(dash Size)
(formerly Weatherhead 3171x)

NPTF square head plug thread

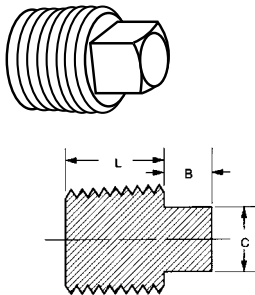

FF4177-(Dash size)
(Formerly Weatherhead series C3179x)

Dash size	Male pipe thread	B		C		L	
		mm	in	mm	in	mm	in
02S	1/8	6,4	0.25	7,1	0.28	8,6	0.34
04S	1/4	7,4	0.29	9,7	0.38	13,0	0.51
06S	3/8	8,1	0.32	11,2	0.44	13,0	0.51
08S	1/2	10,2	0.40	14,2	0.56	17,3	0.68
12S	3/4	11,7	0.46	16,0	0.63	17,5	0.69
16S	1	13,2	0.52	16,7	0.81	21,6	0.85

Seal-nut for NPTF male pipe thread

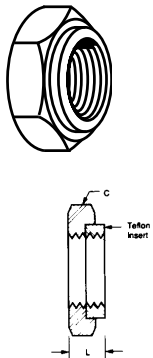

FF91494-(Dash size)
(Formerly Weatherhead series C3059x)

Dash size	Pipe thread	Hex C		L	
		mm	in	mm	in
02S	1/8	15,9	5/8	3,8	.15
04S	1/4	19,5	3/4	6,4	.25
06S	3/8	22,2	7/8	6,4	.25
08S	1/2	28,6	1 1/8	6,4	.25
12S	3/4	33,3	1 5/16	6,4	.25
16S	1	41,3	1 5/8	8,6	.34

Pipe to pipe

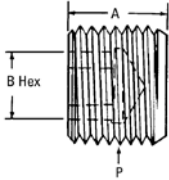
NPTF external pipe/Plug
countersunk hex

2222-(Dash size) (Ref. SAE 140109N)
(Formerly Weatherhead series C3169x)

Dash size	Threads P1	A		B	
		mm	in	mm	in
2S	1/8-27	7,6	0.30	4,8	0.19
4S	1/4-18	11,7	0.46	6,4	0.25
6S	3/8-18	11,7	0.46	7,9	0.31
8S	1/2-14	15,5	0.61	9,7	0.38

NPTF external pipe/ NPTF internal pipe

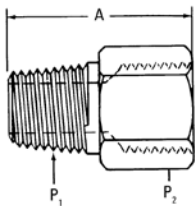

2040-(Dash size) (Ref. SAE 140139)
(Formerly Weatherhead series C3209x)

Dash size	Threads P1	Threads P2	A	
			mm	in
2-2S	1/8-27	1/8-27	26,4	1.04
2-4S	1/8-27	1/4-18	30,7	1.21
2-8S	1/8-27	1/2-14	38,1	1.50
4-4S	1/4-18	1/4-18	35,3	1.39
4-6S	1/4-18	3/8-18	36,6	1.44
4-8S	1/4-18	1/2-14	42,7	1.68
4-12S	1/4-18	3/4-14	44,2	1.74
6-6S	3/8-18	3/8-18	36,6	1.44
6-8S	3/8-18	1/2-14	42,7	1.68
8-8S	1/2-14	1/2-14	47,5	1.87
8-12S	1/2-14	3/4-14	49,0	1.93
8-16S	1/2-14	1-11 1/2	53,1	2.09
12-12S	3/4-14	3/4-14	49,0	1.93
12-16S	3/4-14	1-11 1/2	55,4	2.18
16-16S	1-11 1/2	1-11 1/2	60,2	2.37
16-20S	1-11 1/2	1 1/4-11 1/2	62,5	2.46
20-20S	1 1/4-11 1/2	1 1/4-11 1/2	63,2	2.49
20-24S	1 1/4-11 1/2	1 1/2-11 1/2	63,5	2.50
24-24S	1 1/2-11 1/2	1 1/2-11 1/2	64,3	2.53
24-32S	1 1/2-11 1/2	2-11 1/2	66,8	2.63
32-32S	2-11 1/2	2-11 1/2	67,6	2.66

Steel adapters

Pipe to pipe

Pipe to pipe

NPSM internal pipe swivel/NPTF external pipe

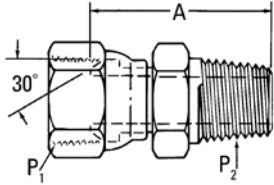

2045-(Dash size) (Ref. SAE 140130)
(Formerly Weatherhead series 9205x)

Dash size	Threads P1	Threads P2	A	
			mm	in
2-2S	1/8-27	1/8-27	24,4	0.96
2-4S	1/8-27	1/4-18	29,0	1.14
4-4S	1/4-18	1/4-18	32,0	1.26
4-6S	1/4-18	3/8-18	32,0	1.26
4-8S	1/4-18	1/2-14	38,4	1.51
6-4S	3/8-18	1/4-18	32,0	1.26
6-6S	3/8-18	3/8-18	33,5	1.32
6-8S	3/8-18	1/2-14	40,1	1.58
8-6S	1/2-14	3/8-18	34,8	1.37
8-8S	1/2-14	1/2-14	41,1	1.62
8-12S	1/2-14	3/4-14	41,1	1.62
12-8S	3/4-14	1/2-14	44,4	1.75
12-12S	3/4-14	3/4-14	44,5	1.75
12-16S	3/4-14	1-11 1/2	50,8	2.00
16-12S	1-11 1/2	3/4-14	44,7	1.76
16-16S	1-11 1/2	1-11 1/2	51,3	2.02
16-20S	1-11 1/2	1 1/4-11 1/2	52,8	2.08
20-16S	1 1/4-11 1/2	1-11 1/2	53,3	2.10
20-20S	1 1/4-11 1/2	1 1/4-11 1/2	52,8	2.08
20-24S	1 1/4-11 1/2	1 1/2-11 1/2	54,4	2.14
24-20S	1 1/2-11 1/2	1 1/4-11 1/2	55,1	2.17
24-24S	1 1/2-11 1/2	1 1/2-11 1/2	55,9	2.20
32-32S	2-11 1/2	2-11 1/2	60,7	2.39

NPSM Internal pipe swivel/ NPTF external pipe

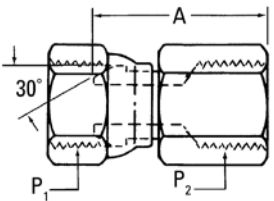

2046-(Dash size) (Ref. SAE 140131)
(Formerly Weatherhead series 9255x)

Dash size	Threads P1	Threads P2	A	
			mm	in
2-2S	1/8-27	1/8-27	23,9	0.94
2-4S	1/8-27	1/4-18	26,9	1.06
4-4S	1/4-18	1/4-18	33,0	1.30
4-6S	1/4-18	3/8-18	33,3	1.31
6-6S	3/8-18	3/8-18	33,8	1.33
6-8S	3/8-18	1/2-14	36,8	1.45
8-6	1/2-14	3/8-18	35,3	1.39
8-8S	1/2-14	1/2-14	39,6	1.56
12-12S	3/4-14	3/4-14	45,0	1.77
12-16S	3/4-14	1-11 1/2	51,8	2.04
16-16S	1-11 1/2	1-11 1/2	52,3	2.06
20-20S	1 1/4-11 1/2	1 1/4-11 1/2	52,3	2.06
24-24S	1 1/2-11 1/2	1 1/2-11 1/2	55,4	2.18
32-32S	2-11 1/2	2-11 1/2	58,4	2.30

Pipe to pipe

Coupling – NPTF internal pipe/internal pipe

2096-(Dash size) (Ref. SAE 140138)
(Formerly Weatherhead series C3309x)

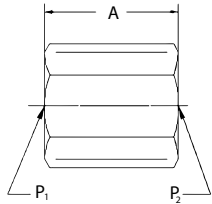

Dash size	Threads P1	Thread P2	A	
			mm	in
2S	1/8-27	1/8-27	19,1	0.75
4-2S*	1/4-18	1/8-27	28,7	1.13
4S*	1/4-18	1/4-18	28,7	1.13
6-4S	3/8-18	1/4-18	28,7	1.13
6S*	3/8-18	3/8-18	28,7	1.13
8-4S	1/2-14	1/4-18	38,1	1.50
8-6S	1/2-14	3/8-18	38,1	1.50
8S*	1/2-14	1/2-14	38,1	1.50
12-8S	3/4-14	1/2-14	38,9	1.53
12S*	3/4-14	3/4-14	38,9	1.53
16-12S	1-11 1/2	3/4-14	48,0	1.89
16S	1-11 1/2	1-11 1/2	48,0	1.89
20S*	1 1/4-11 1/2	1 1/4-11 1/2	49,0	1.93
24S	1 1/2-11 1/2	1 1/2-11 1/2	49,0	1.93
32S	2-11 1/2	2-11 1/2	49,8	1.96

* Also available in stainless steel as part number 259-2096-(dash size).
(formerly Weatherhead 3321x)

NPTF external pipe/external pipe

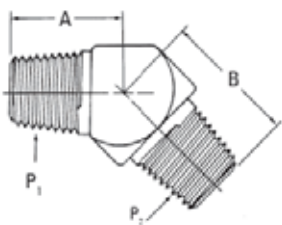

2247-(Dash size) (Ref. SAE 140337)

Dash size	Threads P1	Thread P2	A		B	
			mm	in	mm	in
2-2S	1/8-27	1/8-27	17,0	0.67	17,0	0.67
4-4S	1/4-18	1/4-18	21,8	0.86	21,8	0.86
6-4S	3/8-18	1/4-18	24,1	0.95	24,1	0.95
6-6S	3/8-18	3/8-18	24,1	0.95	24,1	0.95
8-8S	1/2-14	1/2-14	28,7	1.13	29,7	1.17
12-12S	3/4-14	3/4-14	29,7	1.17	30,5	1.20
16-16S	1-11 1/2	1-11 1/2	30,5	1.20	37,6	1.48
20-20S	1 1/4-11 1/2	1 1/4-11 1/2	47,7	1.88	39,1	1.54

NPSM Internal pipe swivel/ NPTF internal pipe

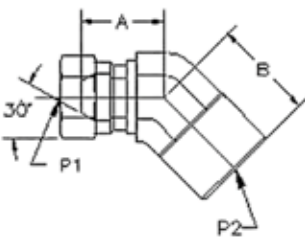

2050-(Dash size) (Ref. SAE 140331)
(Formerly Weatherhead series 9385x)

Dash size	Threads P1	Thread P2	A		B	
			mm	in	mm	in
2-2S	1/8-27	1/8-27	15,7	0.62	12,7	0.50
4-4S	1/4-18	1/4-18	20,1	0.79	24,6	0.97
4-6S	1/4-18	3/8-18	23,4	0.92	30,0	1.18
6-6S	3/8-18	3/8-18	23,4	0.92	30,0	1.18
6-8S	3/8-18	1/2-14	21,8	0.86	35,8	1.41
8-8S	1/2-14	1/2-14	23,1	0.91	35,8	1.41
12-12S	3/4-14	3/4-14	27,9	1.10	38,9	1.53
16-16S	1-11 1/2	1-11 1/2	32,0	1.26	38,9	1.53
20-20S	1 1/4-11 1/2	1 1/4-11 1/2	31,2	1.23	36,6	1.44

Steel adapters

Pipe to pipe

Pipe to pipe

NPSM internal pipe swivel/NPTF external pipe

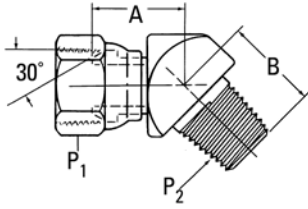

2049-(Dash size) (Ref. SAE 140330)
(Formerly Weatherhead series 9355x)

Dash size	Threads P1	Thread P2	A		B	
			mm	in	mm	in
2-2S	1/8-27	1/8-27	17,0	0.67	17,8	0.70
4-2S	1/4-18	1/8-27	20,1	0.79	17,0	0.67
4-4S	1/4-18	1/4-18	20,1	0.79	24,6	0.97
4-6S	1/4-18	3/8-18	20,3	0.80	26,9	1.06
4-8S	1/4-18	1/2-14	21,1	0.83	35,8	1.41
6-4S	3/8-18	1/4-18	23,4	0.92	25,4	1.00
6-6S	3/8-18	3/8-18	23,4	0.92	27,7	1.09
6-8S	3/8-18	1/2-14	23,4	0.92	35,8	1.41
8-6S	1/2-14	3/8-18	23,1	0.91	27,7	1.09
8-8S	1/2-14	1/2-14	23,1	0.91	35,8	1.41
8-12S	1/2-14	3/4-14	23,1	0.91	38,9	1.53
12-8S	3/4-14	1/2-14	27,9	1.10	38,9	1.53
12-12S	3/4-14	3/4-14	27,9	1.10	38,9	1.53
12-16S	3/4-14	1-11 1/2	26,2	1.03	38,1	1.50
16-12S	1-11 1/2	1/4-14	32,0	1.26	38,9	1.53
16-16S	1-11 1/2	1-11 1/2	32,0	1.26	38,9	1.53
16-20S	1-11 1/2	1 1/4-11 1/2	33,0	1.30	46,7	1.84
20-20S	1 1/4-11 1/2	1 1/4-11 1/2	36,8	1.45	46,7	1.84
24-24S	1 1/2-11 1/2	1 1/2-11 1/2	35,8	1.41	50,8	2.00

NPTF internal pipe/NPTF external pipe

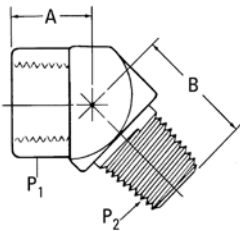

2088-(Dash size) (Ref. SAE 140339)
(Formerly Weatherhead series C3359x)

Dash size	Threads P1	Thread P2	A		B	
			mm	in	mm	in
2-2S	1/8-27	1/8-27	11,9	0.47	18,3	0.72
4-4S	1/4-18	1/4-18	15,7	0.62	26,7	1.05
6-6S	3/8-18	3/8-18	18,3	0.72	26,9	1.06
8-8S	1/2-14	1/2-14	23,1	0.91	34,0	1.34
12-12S	3/4-14	3/4-14	24,6	0.97	35,1	1.38
16-16S	1-11 1/2	1-11 1/2	28,4	1.12	43,7	1.72

Pipe to pipe

NPTF 45° Female pipe elbow

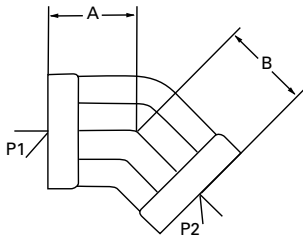

2086-S-(Dash size) (Ref. SAE 140338)
(Formerly Weatherhead series C3559x)

Dash size	Thread P1	Thread P2	A		B	
			mm	in	mm	in
4-4S	1/4-18	1/4-18	17,5	0.69	17,5	0.69
6-6S	3/8-18	3/8-18	19,0	0.75	19,0	0.75
8-8S	1/2-14	1/2-14	23,9	0.94	23,9	0.94
12-12S	3/4-14	3/4-14	25,4	1.00	25,4	1.00
16-16S	1-11 1/2	1-11 1/2	30,2	1.19	30,2	1.19

NPTF external pipe/NPTF external pipe

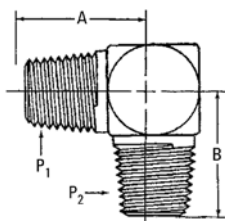

2085-(Dash size) (Ref. SAE 140237)
(Formerly Weatherhead series C3529x)

Dash size	Threads P1	Thread P2	A		B	
			mm	in	mm	in
2-2S	1/8-27	1/8-27	19,8	0.78	19,8	0.78
4-4S	1/4-18	1/4-18	27,7	1.09	27,7	1.09
6-4S	3/8-18	1/4-18	31,0	1.22	31,0	1.22
6-6S	3/8-18	3/8-18	31,0	1.22	31,0	1.22
8-6S	1/2-14	3/8-18	37,3	1.47	32,5	1.28
8-8S	1/2-14	1/2-14	37,3	1.47	37,3	1.47
12-8S	3/4-14	1/2-14	40,4	1.59	40,4	1.59
12-12S	3/4-14	3/4-14	40,4	1.59	40,4	1.59
16-12S	1-11 1/2	3/4-14	50,0	1.97	45,2	1.78
16-16S	1-11 1/2	1-11 1/2	50,0	1.97	50,0	1.97

Steel adapters

Pipe to pipe

Pipe to pipe

NPTF external pipe/hose Connector

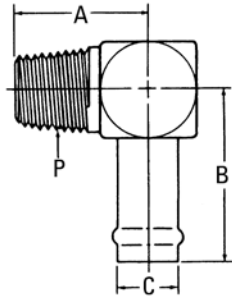

FF1162-(Dash size) (Ref. SAE 430260)

Dash size	Tube O.D.		Threads T1	A		B		C	
	mm	in		mm	in	mm	in	mm	in
0406S	9,7	0.38	1/4-18	27,7	1.09	39,1	1.54	9,7	0.38
1212S	19,0	0.75	3/4-14	35,8	1.41	46,5	1.83	19,0	0.75
1616S	25,4	1.00	1-11 1/2	50,0	1.97	49,3	1.94	25,4	1.00
2020S	31,8	1.25	1 1/4-11 1/2	49,8	1.96	54,6	2.15	31,7	1.25

Note: Clamp required.

NPTF external pipe swivel/ NPTF external pipe

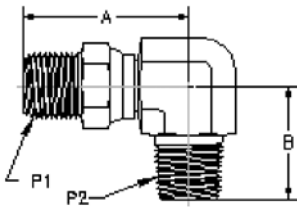

2251-(Dash size)

(Formerly Weatherhead series 9435x)

Dash size	Threads P1	Thread P2	A		B	
			mm	in	mm	in
4-4S	1/4-18	1/4-18	43,7	1.72	27,7	1.09
6-6S	3/8-18	3/8-18	45,2	1.78	31,0	1.22
8-8S	1/2-14	1/2-14	54,4	2.14	37,3	1.47
12-12S	3/4-14	3/4-14	66,3	2.61	40,4	1.59

Note: The above adapter is not a rotating union or swivel joint. Care must be exercised to avoid misuse. To be used with petroleum or water glycol fluids.

NPTF external pipe/ NPTF internal pipe

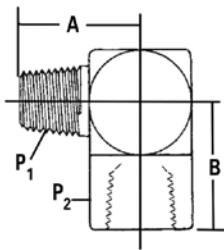

2089-(Dash size) (Ref. SAE 140239)

(Formerly Weatherhead series C3409x)

Dash size	Threads P1	Thread P2	A		B	
			mm	in	mm	in
2-2S	1/8-27	1/8-27	19,8	0.78	16,8	0.66
2-4S	1/8-27	1/4-18	22,9	0.90	22,4	0.88
4-2S	1/4-18	1/8-27	27,7	1.09	17,0	0.67
4-4S	1/4-18	1/4-18	27,7	1.09	22,4	0.88
4-6S	1/4-18	3/8-18	31,0	1.22	25,9	1.02
6-4S	3/8-18	1/4-18	31,0	1.22	25,7	1.01
6-6S*	3/8-18	3/8-18	31,0	1.22	25,9	1.02
6-8S	3/8-18	1/2-14	32,5	1.28	31,2	1.23
8-6S	1/2-14	3/8-18	37,3	1.47	25,7	1.01
8-8S	1/2-14	1/2-14	37,3	1.47	31,2	1.23
8-12S	1/2-14	3/4-14	40,4	1.59	34,5	1.36
12-8S	3/4-14	1/2-14	40,4	1.59	34,3	1.35
12-12S	3/4-14	3/4-14	40,4	1.59	34,5	1.36
16-16S	1-11 1/2	1-11 1/2	50,0	1.97	41,1	1.62
20-20S	1 1/4-11 1/2	1 1/4-11 1/2	60,5	2.38	43,2	1.70
24-24S	1 1/2-11 1/2	1 1/2-11 1/2	67,1	2.64	52,8	2.08
32-32S	2-11 1/2	2-11 1/2	76,2	3.00	60,7	2.39

* Also available in stainless steel as part number 259-2089-(dash Size). (Formerly Weatherhead 3421x)

Pipe to pipe

NPTF external pipe swivel/ NPTF internal pipe

2252-(Dash size)

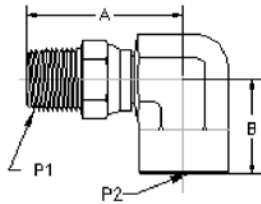

Dash size	Threads P1	Thread P2	A		B	
			mm	in	mm	in
2-2S	1/8-27	1/8-27	35,1	1.38	17,3	0.68
4-4S	1/4-18	1/4-18	43,7	1.72	22,4	0.88
6-6S	3/8-18	3/8-18	45,2	1.78	25,9	1.02
8-8S	1/2-14	1/2-14	54,4	2.14	31,2	1.23
12-12S	3/4-14	3/4-14	66,3	2.61	40,4	1.59

Note: The above adapter is not a rotating union or swivel joint. Care must be exercised to avoid misuse. To be used with petroleum or water glycol fluids.

NPSM internal pipe swivel/NPTF internal pipe

2048-(Dash size) (Ref. SAE 140231) (Formerly Weatherhead series 9455x)

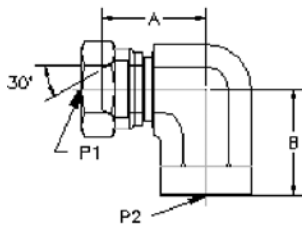

Dash size	Threads P1	Thread P2	A		B	
			mm	in	mm	in
2-2S	1/8-27	1/8-27	19,8	0.78	16,8	0.66
4-4S	1/4-18	1/4-18	23,1	0.91	24,6	1.0
4-6S	1/4-18	3/8-18	25,4	1.00	27,7	1.09
4-8S	1/4-18	1/2-14	27,7	1.09	33,0	1.30
6-4S	3/8-18	1/4-18	24,6	0.97	24,6	0.97
6-6S	3/8-18	3/8-18	27,7	1.09	27,7	1.09
6-8S	3/8-18	1/2-14	27,9	1.10	34,0	1.34
8-6S	1/2-14	3/8-18	27,4	1.08	34,0	1.34
8-8S	1/2-14	1/2-14	27,4	1.08	34,0	1.34
8-12S	1/2-14	3/4-14	37,3	1.47	34,5	1.36
12-8S	3/4-14	1/2-14	31,5	1.24	31,2	1.23
12-12S	3/4-14	3/4-14	34,5	1.36	38,9	1.53
16-16S	1-11 1/2	1-11 1/2	39,6	1.56	45,2	1.78
20-20S	1 1/4-11 1/2	1 1/4-11 1/2	46,2	1.82	51,6	2.03
24-24S	1 1/2-11 1/2	1 1/2-11 1/2	51,3	2.02	57,9	2.28

Steel adapters

Pipe to pipe

Pipe to pipe

NPSM internal pipe swivel/ NPTF external pipe

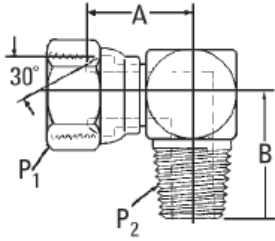

2047-(Dash size) (Ref. SAE 140230)
(Formerly Weatherhead series 9405x)

Dash size	Threads P1	Thread P2	A		B	
			mm	in	mm	in
2-2S	1/8-27	1/8-27	18,0	0.71	26,2	1.03
2-4S	1/8-27	1/4-18	19,6	0.77	27,7	1.09
4-2S	1/4-18	1/8-27	22,4	0.88	22,9	0.90
4-4S	1/4-18	1/4-18	23,1	0.91	32,5	1.28
4-6S	1/4-18	3/8-18	27,7	1.09	38,9	1.53
4-8S	1/4-18	1/2-14	26,2	1.03	46,7	1.84
6-4S	3/8-18	1/4-18	25,1	0.99	31,0	1.22
6-6S	3/8-18	3/8-18	27,7	1.09	38,9	1.53
6-8S	3/8-18	1/2-14	26,2	1.03	46,7	1.84
6-12S	3/8-18	3/4-14	32,0	1.26	40,4	1.59
8-6S	1/2-14	3/8-18	27,4	1.08	41,9	1.65
8-8S	1/2-14	1/2-14	27,4	1.08	46,7	1.84
8-12S	1/2-14	3/4-14	31,5	1.24	51,6	2.03
12-8S	3/4-14	1/2-14	34,5	1.36	51,6	2.03
12-12S	3/4-14	3/4-14	34,5	1.36	51,6	2.03
12-16S	3/4-14	1-11 1/2	38,4	1.51	61,2	2.41
16-12S	1-11 1/2	3/4-14	38,9	1.53	56,4	2.22
16-16S	1-11 1/2	1-11 1/2	38,9	1.53	61,2	2.41
20-20S	1 1/4-11 1/2	1 1/4-11 1/2	46,2	1.82	67,3	2.65
24-24S	1 1/2-11 1/2	1 1/2-11 1/2	51,3	2.02	72,1	2.84
32-32S	2-11 1/2	2-11 1/2	60,2	2.37	84,8	3.34

90° Elbow long – Female pipe swivel/NPTF male pipe

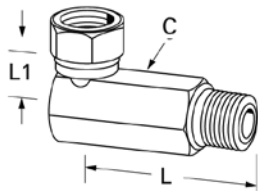

FF4175-(Dash size)
(Formerly Weatherhead series 9405xLL)

Dash size	NPSM Swivel nut	Male pipe thread	Hex C		L		L1	
			mm	in	mm	in	mm	in
0202S	1/8-27	1/8-27	14,2	0.56	48,2	1.90	17,8	0.70
0404S	1/4-18	1/4-18	17,5	0.69	65,3	2.57	19,5	0.75
0606S	3/8-18	3/8-18	20,6	0.81	80,3	3.16	22,9	0.90
0808S	1/2-14	1/2-14	25,4	1.00	93,2	3.67	25,9	1.02
1212S	3/4-14	3/4-14	31,8	1.25	109,0	4.29	30,5	1.20
1616S	1-11 1/2	1-11 1/2	38,1	1.50	128,5	5.06	37,1	1.46

Pipe to pipe

NPTF internal pipe/NPTF internal pipe

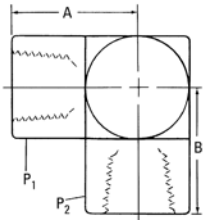

2087-(Dash size) (Ref. SAE 140238)
(Formerly Weatherhead series C3509x)

Dash size	Threads P1	Thread P2	A		B	
			mm	in	mm	in
2-2S	1/8-27	1/8-27	16,8	0.66	16,8	0.66
4-2S	1/4-18	1/8-27	22,4	0.88	17,0	0.67
4-4S*	1/4-18	1/4-18	22,4	0.88	22,4	0.88
6-4S	3/8-18	1/4-18	25,9	1.02	25,7	1.01
6-6S	3/8-18	3/8-18	25,9	1.02	25,9	1.02
8-6S	1/2-14	3/8-18	31,2	1.23	25,7	1.01
8-8S	1/2-14	1/2-14	31,2	1.23	31,2	1.23
12-8S	3/4-14	1/2-14	34,5	1.36	34,3	1.35
12-12S	3/4-14	3/4-14	34,5	1.36	34,5	1.36
16-12S	1-11 1/2	3/4-14	41,1	1.62	35,3	1.39
16-16S	1-11 1/2	1-11 1/2	41,1	1.62	41,1	1.62
20-20S	1 1/4-11 1/2	1 1/4-11 1/2	43,2	1.70	43,2	1.70
24-24S	1 1/2-11 1/2	1 1/2-11 1/2	52,8	2.08	52,8	2.08

* Also available in stainless steel as part number 259-2087-(dash size).
(Formerly Weatherhead 3521x)

NPTF external pipe/NPTF external pipe

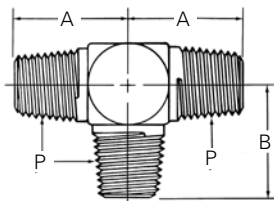

2257-(Dash size)

Dash size	Threads P1	A		B	
		mm	in	mm	in
2-2S	1/8-27	19,8	0.78	19,8	0.78
4-4S	1/4-18	27,7	1.09	27,7	1.09
6-6S	3/8-18	31,0	1.22	31,0	1.22
8-8S	1/2-14	37,3	1.47	37,3	1.47
12-12S	3/4-14	40,4	1.59	40,4	1.59
16-16S	1-11 1/2	50,0	1.97	50,0	1.97

Steel adapters

Pipe to pipe

Pipe to pipe

NPTF external pipe/NPTF internal pipe

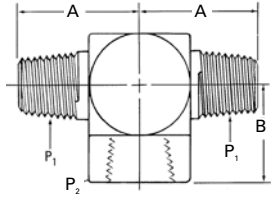

2256-(Dash size)

Dash size	Threads P1	Thread P2	A		B	
			mm	in	mm	in
2-2S	1/8-27	1/8-27	19,8	0.78	16,8	0.66
4-4S	1/4-18	1/4-18	27,7	1.09	22,3	0.88
6-6S	3/8-18	3/8-18	31,0	1.22	25,9	1.02
8-8S	1/2-14	1/2-14	37,3	1.47	31,2	1.23
12-12S	3/4-14	3/4-14	40,4	1.59	34,5	1.36
16-16S	1-11 1/2	1-11 1/2	65,3	2.57	43,2	1.70

NPTF external pipe/NPTF internal pipe

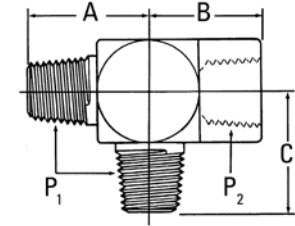

2093-(Dash size)

(Formerly Weatherhead series C3805x)

Dash size	Threads P1	Thread P2	A		B		C	
			mm	in	mm	in	mm	in
2-2S	1/8-27	1/8-27	19,8	0.78	16,8	0.66	19,8	0.78
4-4S	1/4-18	1/4-18	27,7	1.09	22,3	0.88	27,7	1.09
6-6S	3/8-18	3/8-18	31,0	1.22	25,9	1.02	31,0	1.22
8-8S	1/2-14	1/2-14	37,3	1.47	31,2	1.23	37,3	1.47
12-12S	3/4-14	3/4-14	40,4	1.59	34,5	1.36	40,4	1.59
16-16S	1-11 1/2	1-11 1/2	50,0	1.97	41,1	1.62	50,0	1.97

NPTF external pipe/NPTF internal pipe

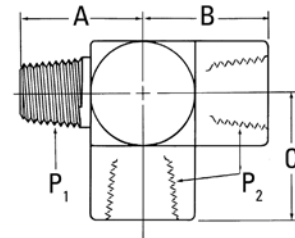

2092-(Dash size) (Ref. SAE 140424)

(Formerly Weatherhead series C3759x)

Dash size	Threads P1	Thread P2	A		B		C	
			mm	in	mm	in	mm	in
2-2S	1/8-27	1/8-27	19,8	0.78	16,8	0.66	16,8	0.66
4-4S	1/4-18	1/4-18	27,7	1.09	22,4	0.88	22,4	0.88
6-6S	3/8-18	3/8-18	31,0	1.22	25,9	1.02	25,9	1.02
8-8S	1/2-14	1/2-14	37,3	1.47	31,2	1.23	31,2	1.23
12-12S	3/4-14	3/4-14	40,4	1.59	34,5	1.36	34,5	1.36
16-16S	1-11 1/2	1-11 1/2	50,0	1.97	41,1	1.62	41,1	1.62
20-20S	1 1/4-11 1/2	1 1/4-11 1/2	60,5	2.38	43,2	1.70	43,2	1.70

Pipe to pipe

NPSM internal pipe swivel/NPTF external pipe

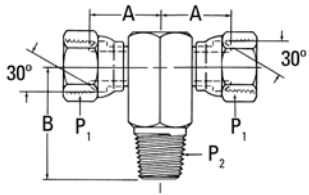

2254-(Dash size)
(Formerly Weatherhead series 9406x)

Dash size	Threads P1	Thread P2	A		B	
			mm	in	mm	in
2-2S	1/8-27	1/8-27	17,8	0.7	18,3	0.72
4-4S	1/4-18	1/4-18	22,4	0.88	27,7	1.09
4-6S	1/4-18	3/8-18	25,1	0.99	31,0	1.22
4-8S	1/4-18	1/2-14	25,9	1.02	37,3	1.47
6-6S	3/8-18	3/8-18	27,7	1.09	38,9	1.53
6-8S	3/8-18	1/2-14	27,7	1.09	37,3	1.47
8-8S	1/2-14	1/2-14	27,9	1.10	37,3	1.47
12-12S	3/4-14	3/4-14	34,5	1.36	51,6	2.03

NPSM internal pipe swivel

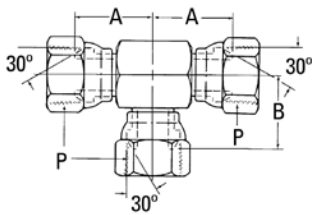

2255-(Dash size)
(Formerly Weatherhead series 9705x)

Dash size	Threads P1	A		B	
		mm	in	mm	in
2-2S	1/8-27	18,0	0.71	18,0	0.71
4-4S	1/4-18	23,1	0.91	23,1	0.91
6-6S	3/8-18	25,1	0.99	25,1	0.99
8-8S	1/2-14	27,4	1.08	27,4	1.08
12-12S	3/4-14	34,5	1.36	34,5	1.36

NPSM internal pipe swivel/ NPTF internal pipe

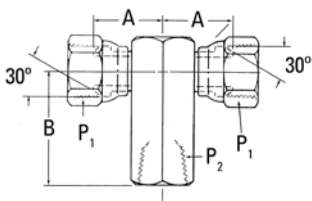

2253-(Dash size)
(Formerly Weatherhead series 9456x)

Dash size	Threads P1	Thread P2	A		B	
			mm	in	mm	in
6-6S	3/8-18	3/8-18	26,9	1.06	25,9	1.02
8-8S	1/2-14	1/2-14	31,5	1.24	31,2	1.23
12-12S	3/4-14	3/4-14	36,5	1.44	34,5	1.36

Steel adapters

Pipe to pipe

Pipe to pipe

NPTF external pipe/ NPTF internal pipe

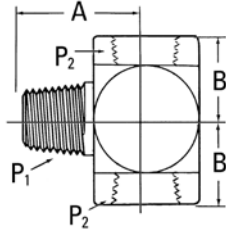

2091-(Dash size) (Ref. SAE 140425)
(Formerly Weatherhead series C3609x)

Dash size	Threads P1	Thread P2	A		B	
			mm	in	mm	in
2-2S	1/8-27	1/8-27	19,8	0.78	16,8	0.66
4-4S*	1/4-18	1/4-18	27,7	1.09	22,4	0.88
6-6S	3/8-18	3/8-18	31,0	1.22	25,9	1.02
8-8S	1/2-14	1/2-14	37,3	1.47	31,2	1.23
12-12S	3/4-14	3/4-14	40,4	1.59	34,5	1.36
16-16S	1-11 1/2	1-11 1/2	50,0	1.97	41,1	1.62

* Also available in stainless steel as part number 259-2091-(dash size).

NPTF internal pipe/NPTF internal pipe

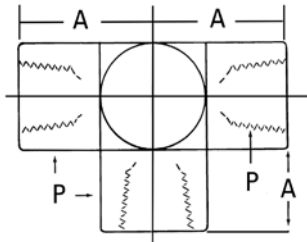

2090-(Dash size) (Ref. SAE 140438)
(Formerly Weatherhead series C3709x)

Dash size	Threads P1	A	
		mm	in
2-2S	1/8-27	16,8	0.66
4-4S	1/4-18	22,4	0.88
6-6S	3/8-18	25,9	1.02
8-8S	1/2-14	31,2	1.23
12-12S	3/4-14	34,5	1.36
16-16S	1-11 1/2	41,1	1.62
20-20S	1 1/4-11 1/2	43,2	1.70
24-24S	1 1/2-11 1/2	52,8	2.08

NPTF internal pipe/NPTF internal pipe

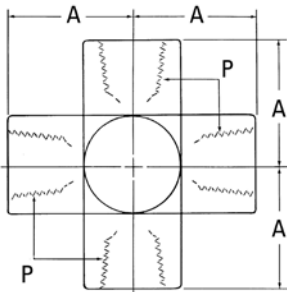

2080-(Dash size)
(Formerly Weatherhead series C3959x)

Dash size	Threads P1	A	
		mm	in
2-2S	1/8-27	16,8	0.66
4-4S	1/4-18	22,3	0.88
6-6S	3/8-18	25,9	1.02
8-8S	1/2-14	31,2	1.23
12-12S	3/4-14	34,5	1.36
16-16S	1-11 1/2	41,1	1.62

Pipe to SAE 37° flare

NPTF external pipe/SAE 37° flare

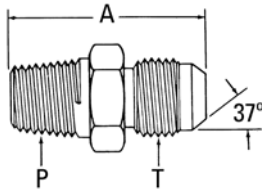

2021-(Dash size) (Ref. SAE 070102)
(Formerly Weatherhead series C5205x)

Dash size	Tube O. D.		Thread P	Thread T	A	
	mm	in			mm	in
2-2S	3,3	0.13	1/8-27	5/16-24	28,2	1.11
2-3S	4,8	0.19	1/8-27	3/8-24	29,0	1.14
2-4S*	6,3	0.25	1/8-27	7/16-20	31,0	1.22
2-5S	7,9	0.31	1/8-27	1/2-20	31,0	1.22
2-6S	9,6	0.38	1/8-27	9/16-18	31,5	1.24
2-8S	12,7	0.50	1/8-27	3/4-16	34,0	1.34
4-4S*	6,3	0.25	1/4-18	7/16-20	36,1	1.42
4-5S*	7,9	0.31	1/4-18	1/2-20	36,1	1.42
4-6S*	9,6	0.38	1/4-18	9/16-18	36,3	1.43
4-8S*	12,7	0.50	1/4-18	3/4-16	38,9	1.53
6-4S*	6,3	0.25	3/8-18	7/16-20	36,1	1.42
6-5S	7,9	0.31	3/8-18	1/2-20	36,1	1.42
6-6S*	9,6	0.38	3/8-18	9/16-18	36,3	1.43
6-8S*	12,7	0.50	3/8-18	3/4-16	38,9	1.53
6-10S*	16,0	0.63	3/8-18	7/8-14	43,2	1.70
6-12S	19,0	0.75	3/8-18	1 1/16-12	44,5	1.75
8-4S	6,3	0.25	1/2-14	7/16-20	42,7	1.68
8-6S*	9,6	0.38	1/2-14	9/16-18	42,9	1.69
8-8S*	12,7	0.50	1/2-14	3/4-16	45,5	1.79
8-10S*	16,0	0.63	1/2-14	7/8-14	48,0	1.89
8-12S*	19,0	0.75	1/2-14	1 1/16-12	52,3	2.06
8-16S	25,4	1.00	1/2-14	1 5/16-12	53,6	2.11
12-6S	9,6	0.38	3/4-14	9/16-18	44,5	1.75
12-8S*	12,7	0.50	3/4-14	3/4-16	47,0	1.85
12-10S*	16,0	0.63	3/4-14	7/8-14	49,5	1.95
12-12S*	19,0	0.75	3/4-14	1 1/16-12	52,3	2.06
12-14S	22,3	0.88	3/4-14	1 3/16-12	53,1	2.09
12-16S*	25,4	1.00	3/4-14	1 5/16-12	53,6	2.11
16-10S	16,0	0.63	1-11 1/2	7/8-14	54,6	2.15
16-12S	19,0	0.75	1-11 1/2	1 1/16-12	57,2	2.25
16-16S*	25,4	1.00	1-11 1/2	1 5/16-12	58,4	2.30
16-20S	31,7	1.25	1-11 1/2	1 5/8-12	61,5	2.42
16-24S	38,1	1.50	1-11 1/2	1 7/8-12	66,5	2.62
16-32S	50,8	2.00	1-11 1/2	2 1/2-12	76,7	3.02
20-12S	19,0	0.75	1 1/4-11 1/2	1 1/16-12	59,9	2.36
20-16S*	25,4	1.00	1 1/4-11 1/2	1 5/16-12	61,0	2.40
20-20S*	31,7	1.25	1 1/4-11 1/2	1 5/8-12	62,2	2.45
20-24S*	38,1	1.50	1 1/4-11 1/2	1 7/8-12	67,3	2.65
20-32S	50,8	2.00	1 1/4-11 1/2	2 1/2-12	77,5	3.05
24-12S	19,0	0.75	1 1/2-11 1/2	1 1/16-12	62,5	2.46
24-16S	25,4	1.00	1 1/2-11 1/2	1 5/16-12	63,8	2.51
24-20S	31,7	1.25	1 1/2-11 1/2	1 5/8-12	64,8	2.55
24-24S*	38,1	1.50	1 1/2-11 1/2	1 7/8-12	68,1	2.68
24-32S	50,8	2.00	1 1/2-11 1/2	2 1/2-12	78,2	3.08
32-32S*	50,8	2.00	2-11 1/2	2 1/2-12	79,0	3.11
40-40S	63,5	2.50	2 1/2-8	3-12	85,9	3.38

* Also available in stainless steel as part number 259-2021-(dash size).
(Formerly Weatherhead 5217x).

Steel adapters

Pipe to SAE 37° flare

Pipe to SAE 37° flare

NPTF external pipe/SAE 37° flare bulkhead

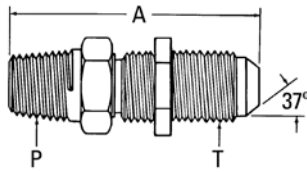

2240-(Dash size)

Dash size	Tube O. D.		Thread P	Thread T	A	
	mm	in			mm	in
2-4S	6,3	0.25	1/8-27	7/16-20	46,7	1.84
4-4S	6,3	0.25	1/4-18	7/16-20	51,6	2.03
4-6S	9,6	0.38	1/4-18	9/16-18	53,8	2.12
6-8S	12,7	0.50	3/8-18	3/4-16	59,9	2.36
8-10S	16,0	0.63	1/2-14	7/8-14	68,8	2.71
12-12S	19,0	0.75	3/4-14	1 1/16-12	74,2	2.92
16-16S	25,4	1.00	1-11 1/2	1 5/16-12	79,0	3.11

Note: Also available in stainless steel as 259-2240-(dash size).

NPTF external pipe/SAE 37° flare

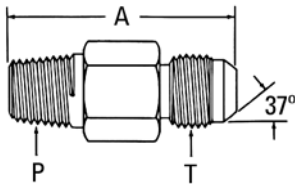

202113-(Dash size)

Dash size	Tube O. D.		Thread P	Thread T	A	
	mm	in			mm	in
2-4S	6,3	0.25	1/8-27	7/16-20	46,0	1.81
2-5S	7,9	0.31	1/8-27	1/2-20	49,3	1.94
4-4S	6,3	0.25	1/4-18	7/16-20	57,2	2.25
4-5S	7,9	0.31	1/4-18	1/2-20	57,2	2.25
4-6S	9,6	0.38	1/4-18	9/16-18	57,2	2.25
6-6S	9,6	0.38	3/8-18	9/16-18	63,5	2.50
6-8S	12,7	0.50	3/8-18	3/4-16	69,8	2.75
8-8S	12,7	0.50	1/2-14	3/4-16	70,9	2.79
8-10S	16,0	0.63	1/2-14	7/8-14	79,2	3.12
8-12S	19,0	0.75	1/2-14	11/16-12	83,3	3.28
12-12S	19,0	0.75	3/4-14	11/16-12	88,9	3.50
16-16S	25,4	1.00	1-11 1/2	15/16-12	101,6	4.00
20-20S	38,1	1.50	1 1/4-11 1/2	1 5/8-12	114,3	4.50
24-24S	38,1	1.50	1 1/2-11 1/2	1 7/8-12	123,9	4.88
32-32S	50,8	2.00	2-11 1/2	2 1/2-12	142,7	5.62

NPTF external pipe/SAE 37° flare

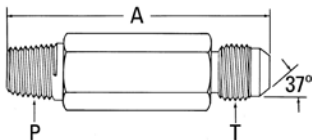

202114-(Dash size)

Dash size	Tube O. D.		Thread P	Thread T	A	
	mm	in			mm	in
2-4S	6,3	0.25	1/8-27	7/16-20	65,0	2.56
4-4S	6,3	0.25	1/4-18	7/16-20	82,5	3.25
4-5S	7,9	0.31	1/4-18	1/2-20	82,5	3.25
4-6S	9,6	0.38	1/4-18	9/16-18	82,5	3.25
6-8S	12,7	0.50	3/8-18	3/4-16	101,6	4.00
8-6S	9,6	0.38	1/2-14	9/16-18	105,9	4.17
8-10S	16,0	0.63	1/2-14	7/8-14	111,2	4.38
12-12S	19,0	0.75	3/4-14	1 1/16-12	127,0	5.00
12-16S	25,4	1.00	3/4-14	1 5/16-12	141,2	5.56
16-16S	25,4	1.00	1-11 1/2	1 5/16-12	146,0	5.75

Pipe to SAE 37° flare

NPTF internal pipe/SAE 37° flare bulkhead

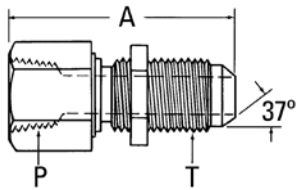

2239-(Dash size) (Ref. SAE 070603)
(Formerly Weatherhead series C5275x)

Dash size	Tube O. D.		Thread P	Thread T	A	
	mm	in			mm	in
2-4S	6,3	0.25	1/8-27	7/16-20	52,8	2.08
4-6S	9,6	0.38	1/4-18	9/16-18	54,6	2.15
6-8S	12,7	0.50	3/8-18	3/4-16	63,0	2.48
8-10S	16,0	0.63	1/2-14	7/8-14	72,1	2.84
12-12S	19,0	0.75	3/4-14	1 1/16-12	77,5	3.05
16-16S	25,4	1.00	1-11 1/2	1 5/16-12	82,6	3.25

Note: Available without nut. Order by part number 2239-1-(dash size).

NPTF external pipe/ SAE 37° flare swivel

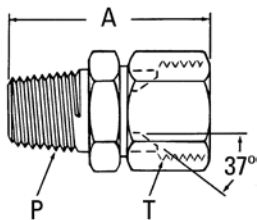

2018-(Dash size)
(Formerly Weatherhead series 9100x)

Dash size	Tube O. D.		Thread P	Thread T	A	
	mm	in			mm	in
2-4S	6,3	0.25	1/8-27	7/16-20	33,6	1.32
4-4S	6,3	0.25	1/4-18	7/16-20	38,1	1.50
4-5S	7,9	0.31	1/4-18	1/2-20	39,4	1.55
4-6S	9,6	0.38	1/4-18	9/16-18	40,4	1.59
6-6S	9,6	0.38	3/8-18	9/16-18	40,4	1.59
6-8S	12,7	0.50	3/8-18	3/4-16	44,2	1.74
6-10S	16,0	0.63	3/8-18	7/8-14	48,8	1.92
8-8S	12,7	0.50	1/2-14	3/4-16	49,0	1.93
8-10S	16,0	0.63	1/2-14	7/8-14	53,8	2.12
8-12S	19,0	0.75	1/2-14	1 1/16-12	56,4	2.22
12-12S	19,0	0.75	3/4-14	1 1/16-12	54,6	2.15
12-16S	25,4	1.00	3/4-14	1 5/16-12	59,6	2.35
16-16S	25,4	1.00	1-11 1/2	1 5/16-12	64,5	2.54
20-20S	31,7	1.25	1 1/4-11 1/2	1 5/8-12	70,6	2.78

NPTF internal pipe/ SAE 37° flare swivel

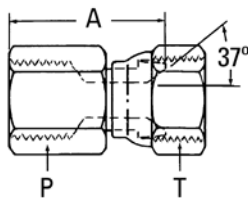

2242-(Dash size) (Ref. SAE 070603)
(Formerly Weatherhead series C5256x)

Dash size	Tube O. D.		Thread P	Thread T	A	
	mm	in			mm	in
2-4S	6,3	0.25	1/8-27	7/16-20	21,6	0.85
2-5S	7,9	0.31	1/8-27	1/2-20	22,1	0.87
4-4S	6,3	0.25	1/4-18	7/16-20	28,2	1.11
4-5S	7,9	0.31	1/4-18	1/2-20	27,9	1.10
4-6S	9,6	0.38	1/4-18	9/16-18	30,0	1.18
6-6S	9,6	0.38	3/8-18	9/16-18	29,5	1.16
6-8S	12,7	0.50	3/8-18	3/4-16	30,5	1.20
8-6S	9,6	0.38	1/2-14	9/16-18	36,1	1.42
8-8S	12,7	0.50	1/2-14	3/4-16	37,6	1.48
8-10S	16,0	0.63	1/2-14	7/8-14	37,3	1.47
8-12S	19,0	0.75	1/2-14	1 1/16-12	36,8	1.45
12-12S	19,0	0.75	3/4-14	1 1/16-12	37,8	1.49
12-14S	22,3	0.88	3/4-14	1 3/16-12	39,4	1.55
16-16S	25,4	1.00	1-11 1/2	1 5/16-12	47,0	1.85
20-20S	31,7	1.25	1 1/4-11 1/2	1 5/8-12	51,3	2.02

Steel adapters

Pipe to SAE 37° flare

Pipe to SAE 37° flare

NPTF internal pipe/SAE 37° flare

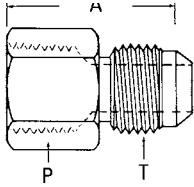

2022-(Dash size) (Ref. SAE 070103)
(Formerly Weatherhead series C5255x)

Dash size	Tube O. D.		Thread P	Thread T	A	
	mm	in			mm	in
2-2S	4,8	0.13	1/8-27	5/16-24	28,4	1.12
2-3S	4,8	0.19	1/8-27	3/8-24	28,7	1.13
2-4S	6,4	0.25	1/8-27	7/16-20	30,2	1.19
2-5S	7,9	0.31	1/8-27	1/2-20	29,7	1.17
4-3S	4,8	0.19	1/4-18	3/8-24	33,5	1.32
4-4S*	6,4	0.25	1/4-18	7/16-20	35,3	1.39
4-5S	7,9	0.31	1/4-18	1/2-20	35,3	1.39
4-6S	9,7	0.38	1/4-18	9/16-18	35,6	1.40
4-8S	12,7	0.50	1/4-18	3/4-16	39,4	1.55
6-6S*	9,7	0.38	3/8-18	9/16-18	37,1	1.46
6-8S*	12,7	0.50	3/8-18	3/4-16	39,6	1.56
6-10S	16,0	0.63	3/8-18	7/8-14	42,9	1.69
8-4S	6,4	0.25	1/2-14	7/16-20	42,7	1.68
8-6S	9,7	0.38	1/2-14	9/16-18	42,9	1.69
8-8S*	12,7	0.50	1/2-14	3/4-16	45,5	1.79
8-10S	16,0	0.63	1/2-14	7/8-14	48,0	1.89
8-12S	19,1	0.75	1/2-14	1 1/16-12	52,1	2.05
12-8S	12,7	0.50	3/4-14	3/4-16	47,0	1.85
12-10S	16,0	0.63	3/4-14	7/8-14	49,5	1.95
12-12S	19,1	0.75	3/4-14	1 1/16-12	52,3	2.06
12-16S	25,4	1.00	3/4-14	1 5/16-12	53,8	2.12
16-12S	19,1	0.75	1-11 1/2	1 1/16-12	58,4	2.30
16-16S	25,4	1.00	1-11 1/2	1 5/16-12	59,7	2.35
20-16S	25,4	1.00	1 1/4-11 1/2	1 5/16-12	62,0	2.44
20-20S	31,8	1.25	1 1/4-11 1/2	1 5/8-12	63,2	2.49
24-24S	38,1	1.50	1 1/2-11 1/2	1 7/8-12	66,5	2.62
32-32S	50,8	2.00	2-11 1/2	2-11 1/2	75,4	2.97

* Also available in stainless steel as part number 259-2022-(dash size).
(Formerly Weatherhead 5267x)

NPTF internal pipe/SAE 37° flare

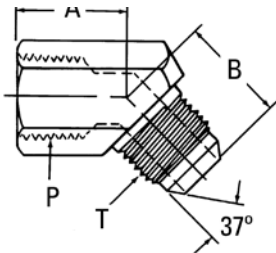

2044-(Dash size)

Dash size	Tube O. D.		Thread P	Thread T	A		B	
	mm	in			mm	in	mm	in
4-6S	9,6	0.38	1/4-18	9/16-18	15,7	0.62	21,0	0.83
6-8S	12,7	0.50	3/8-18	3/4-16	18,3	0.72	24,9	0.98
8-10S	16,0	0.63	1/2-14	7/8-14	23,1	0.91	28,2	1.11
12-12S	19,0	0.75	3/4-14	1 1/16-12	24,6	0.97	34,3	1.35

Pipe to SAE 37° flare

NPTF external pipe/SAE 37° flare

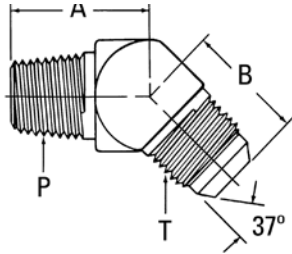

2023-(Dash size) (Ref. SAE 070302)
(Formerly Weatherhead series C5355x)

Dash size	Tube O. D.		Thread P	Thread T	A		B	
	mm	in			mm	in	mm	in
2-3S	4,8	0.19	1/8-27	3/8--24	18,3	0.72	21,1	0.83
2-4S	6,3	0.25	1/8-27	7/16-20	16,3	0.64	18,3	0.72
2-5S	7,9	0.31	1/8-27	1/2-20	16,3	0.64	19,6	0.77
2-6S	9,6	0.38	1/8-27	9/16-18	17,0	0.67	21,1	0.83
4-4S	6,3	0.25	1/4-18	7/16-20	21,8	0.86	20,8	0.82
4-5S	7,9	0.31	1/4-18	1/2-20	21,8	0.86	20,8	0.82
4-6S*	9,6	0.38	1/4-18	9/16-18	21,8	0.86	21,1	0.83
4-8S	12,7	0.50	1/4-18	3/4-16	24,1	0.95	24,9	0.98
6-4S	6,3	0.25	3/8-18	7/16-20	24,1	0.95	21,6	0.85
6-6S	9,6	0.38	3/8-18	9/16-18	24,1	0.95	22,1	0.87
6-8S	12,7	0.50	3/8-18	3/4-16	24,1	0.95	24,9	0.98
6-10S	16,0	0.63	3/8-18	7/8-14	24,9	0.98	28,2	1.11
6-12S	19,0	0.75	3/8-18	1 1/16-12	25,7	1.01	32,5	1.28
8-6S	9,6	0.38	1/2-14	9/16-18	29,7	1.17	22,4	0.88
8-8S	12,7	0.50	1/2-14	3/4-16	29,7	1.17	25,1	0.99
8-10S	16,0	0.63	1/2-14	7/8-14	29,7	1.17	28,2	1.11
8-12S	19,0	0.75	1/2-14	1 1/16-12	30,5	1.20	32,5	1.28
12-8S	12,7	0.50	3/4-14	3/4-16	30,5	1.20	26,4	1.04
12-10S	16,0	0.63	3/4-14	7/8-14	30,5	1.20	29,5	1.16
12-12S	19,0	0.75	3/4-14	1 1/16-12	30,5	1.20	32,5	1.28
12-16S	25,4	1.00	3/4-14	1 5/16-12	32,8	1.29	37,3	1.47
16-12S	19,0	0.75	1-11 1/2	1 1/16-12	37,6	1.48	36,1	1.42
16-16S	25,4	1.00	1-11 1/2	1 5/16-12	37,6	1.48	37,3	1.47
16-20S	31,7	1.25	1-11 1/2	1 5/8-12	41,7	1.64	40,4	1.59
20-20S	31,7	1.25	1 1/4-11 1/2	1 5/8-12	42,4	1.67	40,4	1.59
24-24S	38,1	1.50	1 1/2-11 1/2	1 7/8-12	45,0	1.77	45,2	1.78
32-32S	50,8	2.00	2-11 1/2	2 1/2-12	53,6	2.11	56,4	2.22

* Also available in stainless steel as part number 259-2023-(dash size).
(Formerly Weatherhead 5367x)

NPTF internal pipe/SAE 37° flare swivel

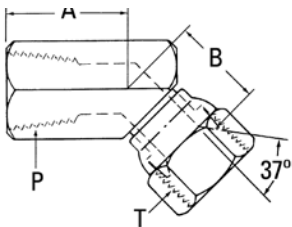

2243-(Dash size)

Dash size	Tube O. D.		Thread P	Thread T	A		B	
	mm	in			mm	in	mm	in
8-6S	9,6	0.38	1/2-14	9/16-18	23,1	0.91	21,3	0.84
8-10S	16,0	0.63	1/2-14	7/8-14	23,1	0.91	23,9	0.94

Steel adapters

Pipe to SAE 37° flare

Pipe to SAE 37° flare

NPTF external pipe/SAE 37° flare

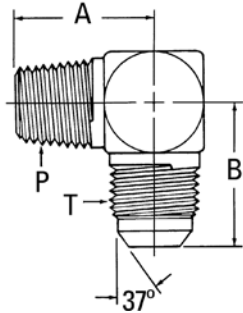

2024-(Dash size) (Ref. SAE 070202)
(Formerly Weatherhead series C5405x)

Dash size	Tube O. D.		Thread P	Thread T	A		B	
	mm	in			mm	in	mm	in
2-3S	4,8	0.19	1/8-27	3/8-24	18,3	0.72	21,1	0.83
2-4S*	6,3	0.25	1/8-27	7/16-20	19,8	0.78	22,6	0.89
2-5S	7,9	0.31	1/8-27	1/2-20	19,8	0.78	24,1	0.95
2-6S	9,6	0.38	1/8-27	9/16-18	22,9	0.90	26,9	1.06
4-4S*	6,3	0.25	1/4-18	7/16-20	27,7	1.09	26,7	1.05
4-5S	7,9	0.31	1/4-18	1/2-20	27,7	1.09	26,7	1.05
4-6S*	9,6	0.38	1/4-18	9/16-18	27,7	1.09	26,9	1.06
4-8S	12,7	0.50	1/4-18	3/4-16	31,0	1.22	31,8	1.25
6-4S	6,3	0.25	3/8-18	7/16-20	31,0	1.22	28,4	1.12
6-5S	7,9	0.31	3/8-18	1/2-20	31,0	1.22	28,4	1.12
6-6S	9,6	0.38	3/8-18	9/16-18	31,0	1.22	29,0	1.14
6-8S	12,7	0.50	3/8-18	3/4-16	31,0	1.22	31,8	1.25
6-10S	16,0	0.63	3/8-18	7/8-14	32,5	1.28	36,8	1.45
6-12S	19,0	0.75	3/8-18	1 1/16-12	35,6	1.40	42,2	1.66
8-4S	6,3	0.25	1/2-14	7/16-20	37,3	1.47	30,7	1.21
8-6S	9,6	0.38	1/2-14	9/16-18	37,3	1.47	31,0	1.22
8-8S*	12,7	0.50	1/2-14	3/4-16	37,3	1.47	33,8	1.33
8-10S	16,0	0.63	1/2-14	7/8-14	37,3	1.47	36,8	1.45
8-12S	19,0	0.75	1/2-14	1 1/16-12	40,4	1.59	42,2	1.66
8-16S	25,4	1.00	1/2-14	1 5/16-12	45,2	1.78	46,0	1.81
12-6S	9,6	0.38	3/4-14	9/16-18	40,4	1.59	33,3	1.31
12-8S	12,7	0.50	3/4-14	3/4-16	40,4	1.59	36,1	1.42
12-10S	16,0	0.63	3/4-14	7/8-14	40,4	1.59	39,1	1.54
12-12S	19,0	0.75	3/4-14	1 1/16-12	40,4	1.59	42,2	1.66
12-16S	25,4	1.00	3/4-14	1 5/16-12	45,2	1.78	46,0	1.81
16-8S	12,7	0.50	1-11 1/2	3/4-16	50,0	1.97	38,6	1.52
16-12S	19,0	0.75	1-11 1/2	1 1/16-12	50,0	1.97	44,7	1.76
16-16S	25,4	1.00	1-11 1/2	1 5/16-12	50,0	1.97	46,0	1.81
16-20S	31,7	1.25	1-11 1/2	1 5/8-12	59,7	2.35	52,3	2.06
20-16S	25,4	1.00	1 1/4-11 1/2	1 5/16-12	60,5	2.38	51,1	2.01
20-20S	31,7	1.25	1 1/4-11 1/2	1 5/8-12	60,5	2.38	52,3	2.06
20-24S	38,1	1.50	1 1/4-11 1/2	1 7/8-12	66,3	2.61	59,2	2.33
24-20S	31,7	1.25	1 1/2-11 1/2	1 5/8-12	67,1	2.64	55,9	2.20
24-24S	38,1	1.50	1 1/2-11 1/2	1 7/8-12	67,1	2.64	59,2	2.33
24-32S	50,8	2.00	1 1/2-11 1/2	2 1/2-12	75,4	2.97	77,7	3.06
32-32S	50,8	2.00	2-11 1/2	2 1/2-12	76,2	3.00	77,7	3.06

* Also available in stainless steel as part number 259-2024-(dash size)
(Formerly Weatherhead 5417x)

Pipe to SAE 37° flare

Extra pipe/SAE 37° flare

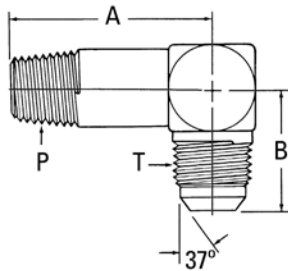

202411-(Dash size) (Ref. SAE 071502)
(Formerly Weatherhead series C5425x)

Dash size	Tube O. D.		Thread P	Thread T	A		B	
	mm	in			mm	in	mm	in
2-4S	6,3	0.25	1/8-27	7/16-20	29,7	1.17	22,6	0.89
2-5S	7,9	0.31	1/8-27	1/2-20	29,7	1.17	24,1	0.95
4-4S	6,3	0.25	1/4-18	7/16-20	40,1	1.58	26,7	1.05
4-6S	9,6	0.38	1/4-18	9/16-18	40,1	1.58	26,9	1.06
4-8S	12,7	0.50	1/4-18	3/4-16	46,2	1.82	31,8	1.25
6-6S	9,6	0.38	3/8-18	9/16-18	46,2	1.82	29,0	1.14
6-8S	12,7	0.50	3/8-18	3/4-16	46,2	1.82	31,8	1.25
8-8S	12,7	0.50	1/2-14	3/4-16	55,1	2.17	33,8	1.33
8-10S	16,0	0.63	1/2-14	7/8-14	55,1	2.17	36,8	1.45
12-10S	16,0	0.63	3/4-14	7/8-14	62,0	2.44	39,1	1.54
12-12S	19,0	0.75	3/4-14	1 1/16-12	62,0	2.44	42,2	1.66
12-16S	25,4	1.00	3/4-14	1 5/16-12	71,6	2.82	46,0	1.81
16-16S	25,4	1.00	1-11 1/2	1 5/16-12	76,5	3.01	46,0	1.81
20-20S	31,70	1.25	1 1/4-11 1/2	1 5/8-12	93,7	3.69	52,3	2.06

Long NPTF external pipe/SAE 37° flare

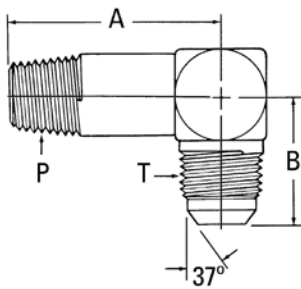

202413-(Dash size) (Ref. SAE 071602)
(Formerly Weatherhead series C5435x)

Dash size	Tube O. D.		Thread P	Thread T	A		B	
	mm	in			mm	in	mm	in
2-4S	6,3	0.25	1/8-27	7/16-20	39,6	1.56	22,6	0.89
2-5S	7,9	0.31	1/8-27	1/2-20	41,4	1.63	24,1	0.95
4-4S	6,3	0.25	1/4-18	7/16-20	52,6	2.07	26,7	1.05
4-5S	7,9	0.31	1/4-18	1/2-20	52,6	2.07	26,7	1.05
4-6S	9,6	0.38	1/4-18	9/16-18	52,6	2.07	26,9	1.06
6-6S	9,6	0.38	3/8-18	9/16-18	61,5	2.42	29,0	1.14
6-8S	12,7	0.50	3/8-18	3/4-16	61,5	2.42	31,8	1.25
8-8S	12,7	0.50	1/2-14	3/4-16	72,9	2.87	33,8	1.33
8-10S	16,0	0.63	1/2-14	7/8-14	72,9	2.87	36,8	1.45
8-12S	19,0	0.75	1/2-14	1 1/16-12	83,3	3.28	42,2	1.66
12-12S	19,0	0.75	3/4-14	1 1/16-12	83,3	3.28	42,2	1.66
12-16S	25,4	1.00	3/4-14	1 5/16-12	98,0	3.86	46,0	1.81
16-16S	25,4	1.00	1-11 1/2	1 5/16-12	102,9	4.05	46,0	1.81
20-20S	31,7	1.25	1 1/4-11 1/2	1 5/8-12	122,9	4.84	52,3	2.06

Steel adapters

Pipe to SAE 37° flare

Pipe to SAE 37° flare

Extra long NPTF external pipe/SAE 37° flare

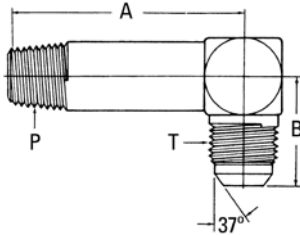

202414-(Dash size)

Dash size	Tube O. D.		Thread P	Thread T	A		B	
	mm	in			mm	in	mm	in
2-4S	6,3	0.25	1/8-27	7/16-20	58,7	2.31	22,6	0.89
4-4S	6,3	0.25	1/4-18	7/16-20	75,9	2.99	24,6	0.97
4-6S	9,6	0.38	3/8-18	9/16-18	77,7	3.06	26,9	1.06
8-10S	16,0	0.63	1/2-14	7/8-14	114,5	4.51	36,8	1.45

NPTF external pipe/SAE 37° flare swivel

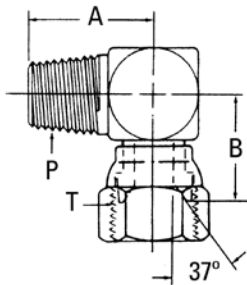

2250-(Dash size)

(Formerly Weatherhead series C5406x)

Dash size	Tube O. D.		Thread P	Thread T	A		B	
	mm	in			mm	in	mm	in
2-4S	6,3	0.25	1/8-27	7/16-20	19,8	0.78	16,8	0.66
2-5S	7,9	0.31	1/8-27	1/2-20	19,8	0.78	17,3	0.68
4-4S	6,3	0.25	1/4-18	7/16-20	27,7	1.09	20,8	0.82
4-6S	9,6	0.38	1/4-18	9/16-18	27,7	1.09	22,3	0.88
6-6S	9,6	0.38	3/8-18	9/16-18	31,0	1.22	21,6	0.85
6-8S	12,7	0.50	3/8-18	3/4-16	31,0	1.22	24,4	0.96
8-8S	12,7	0.50	1/2-14	3/4-16	37,3	1.47	25,4	1.00
8-10S	16,0	0.63	1/2-14	7/8-14	37,3	1.47	28,5	1.12
12-8S	12,7	0.50	3/4-14	3/4-16	40,4	1.59	29,7	1.17
12-12S	19,0	0.75	3/4-14	1 1/16-12	40,4	1.59	30,3	1.19
12-14S	22,3	0.88	3/4-14	1 3/16-12	42,9	1.69	30,5	1.20
16-16S	25,4	1.00	1-11 1/2	1 5/16-12	50,0	1.97	35,8	1.41
20-20S	31,7	1.25	1 1/4-11 1/2	1 5/8-12	60,4	2.38	42,7	1.68
24-24S	38,1	1.50	1 1/2-11 1/2	1 7/8-12	67,0	2.64	47,2	1.86
32-32S	50,8	2.00	2-11 1/2	2 1/2-12	76,2	3.00	62,0	2.44

NPTF external pipe swivel/SAE 37° flare

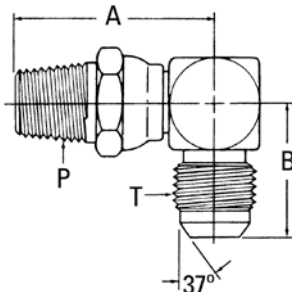

2249-(Dash size)

Dash size	Tube O. D.		Thread P	Thread T	A		B	
	mm	in			mm	in	mm	in
4-6S	9,6	0.38	1/4-18	9/16-18	40,6	1.60	26,9	1.06
6-8S	12,7	0.50	3/8-18	3/4-16	43,4	1.71	31,0	1.22
8-10S	16,0	0.63	1/2-14	7/8-14	50,8	2.00	36,8	1.45
12-12S	19,0	0.75	3/4-14	1 1/16-12	41,1	1.62	42,2	1.66

Note: The above adapter is not a rotating union or swivel joint. Care must be exercised to avoid misuse. To be used with petroleum or water glycol fluids.

Pipe to SAE 37° flare

NPTF internal pipe/SAE 37° flare swivel

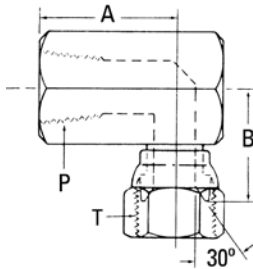

2244-(Dash size)

Dash size	Tube O. D.		Thread P	Thread T	A		B	
	mm	in			mm	in	mm	in
6-6S	9,6	0.38	3/8-18	9/16-18	25,9	1.02	23,4	0.92
8-8S	12,7	0.50	1/2-14	3/4-16	31,2	1.23	27,4	1.08
8-10S	16,0	0.63	1/2-14	7/8-14	31,2	1.23	28,5	1.12

NPTF internal pipe/SAE 37° flare

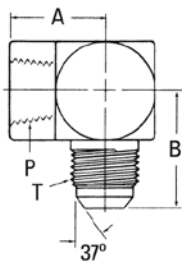

2025-(Dash size) (Ref. SAE 070203) (Formerly Weatherhead series C5455x)

Dash size	Tube O. D.		Thread P	Thread T	A		B	
	mm	in			mm	in	mm	in
2-4S	6,3	0.25	1/8-27	7/16-20	16,8	0.66	27,4	1.08
2-5S	7,9	0.31	1/8-27	1/2-20	16,8	0.66	27,4	1.08
2-6S	9,6	0.38	1/8-27	9/16-18	17,0	0.67	31,2	1.23
4-4S	6,3	0.25	1/4-18	7/16-20	22,4	0.88	31,0	1.22
4-5S	7,9	0.31	1/4-18	1/2-20	22,4	0.88	31,0	1.22
4-6S	9,6	0.38	1/4-18	9/16-18	22,4	0.88	31,2	1.23
4-8S	12,7	0.50	1/4-18	3/4-16	25,7	1.01	36,1	1.42
6-4S	6,3	0.25	3/8-18	7/16-20	25,9	1.02	32,8	1.29
6-5S	7,9	0.31	3/8-18	1/2-20	25,9	1.02	32,8	1.29
6-6S	9,6	0.38	3/8-18	9/16-18	25,9	1.02	33,3	1.31
6-8S	12,7	0.50	3/8-18	3/4-16	25,9	1.02	36,1	1.42
8-4S	6,3	0.25	1/2-14	7/16-20	31,2	1.23	35,6	1.40
8-8S	12,7	0.50	1/2-14	3/4-16	31,2	1.23	38,6	1.52
8-10S	16,0	0.63	1/2-14	7/8-14	31,2	1.23	41,7	1.64
8-12S	19,0	0.75	1/2-14	1 1/16-12	34,3	1.35	48,0	1.89
12-12S	19,0	0.75	3/4-14	1 1/16-12	34,5	1.36	48,0	1.89
16-16S	25,4	1.00	1-11 1/2	1 5/16-12	41,1	1.62	55,1	2.17
20-20S	31,7	1.25	1 1/4-11 1/2	1 5/8-12	43,2	1.70	59,2	2.33
24-24S	38,1	1.50	1 1/2-11 1/2	1 7/8-12	52,8	2.08	73,4	2.89
32-32S	50,8	2.00	2-11 1/2	2 1/2-12	60,7	2.39	83,8	3.30

NPTF external pipe/SAE 37° flare

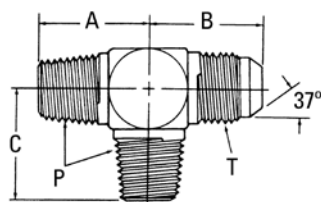

203007-(Dash size)

Dash size	Tube O. D.		Thread P	Thread T	A		B		C	
	mm	in			mm	in	mm	in		
2-4S	6,3	0.25	1/8-27	7/16-20	19,8	0.78	22,6	0.89	19,8	0.78
4-6S	9,6	0.38	1/4-18	9/16-18	27,7	1.09	26,9	1.06	27,7	1.09
6-8S	12,7	0.50	3/8-18	3/4-16	31,0	1.22	31,8	1.25	31,0	1.22
12-12S	19,0	0.75	3/4-14	1 1/16-12	40,4	1.59	42,2	1.66	40,4	1.59
16-16S	25,4	1.00	1-11 1/2	1 5/16-12	50,0	1.97	46,0	1.81	50,0	1.97

Steel adapters

Pipe to SAE 37° flare

Pipe to SAE 37° flare

NPTF external pipe/ NPTF internal pipe/SAE 37° flare

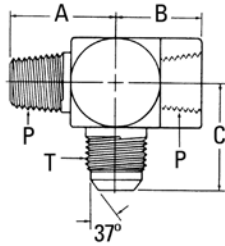

203301-(Dash size)

Dash size	Tube O. D.		Thread P	Thread T	A		B		C	
	mm	in			mm	in	mm	in	mm	in
2-4S	6,3	0.25	1/8-27	7/16-20	19,8	0.78	16,8	0.66	27,4	1.08
4-6S	9,6	0.38	1/4-18	9/16-18	27,7	1.09	22,3	0.88	31,2	1.23
6-8S	12,7	0.50	3/8-18	3/4-16	31,0	1.22	25,9	1.02	36,1	1.42
8-10S	16,0	0.63	1/2-14	7/8-14	37,3	1.47	31,2	1.23	41,6	1.64
12-12S	19,0	0.75	3/4-14	1 1/16-12	40,4	1.59	34,5	1.36	48,0	1.89
16-16S	25,4	1.00	1-11 1/2	1 5/16-12	50,0	1.97	41,1	1.62	55,2	2.17

NPTF external pipe/SAE 37° flare/NPTF internal pipe

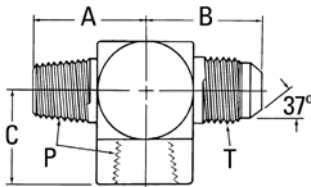

203103-(Dash size)

Dash size	Tube O. D.		Thread P	Thread T	A		B		C	
	mm	in			mm	in	mm	in	mm	in
2-4S	6,3	0.25	1/8-27	7/16-20	19,8	0.78	27,4	1.08	16,8	0.66
4-6S	9,6	0.38	1/4-18	9/16-18	27,7	1.09	31,2	1.23	22,3	0.88
6-6S	9,6	0.38	3/8-18	9/16-18	31,0	1.22	33,3	1.31	25,9	1.02
6-8S	12,7	0.50	3/8-18	3/4-16	31,0	1.22	36,1	1.42	25,9	1.02
8-10S	16,0	0.63	1/2-14	7/8-14	37,3	1.47	41,6	1.64	31,2	1.23
12-12S	19,0	0.75	3/4-14	1 1/16-12	40,4	1.59	48,0	1.89	34,5	1.36
16-16S	25,4	1.00	1-11 1/2	1 5/16-12	53,1	2.09	53,1	2.09	42,1	1.62

NPTF external pipe/SAE 37° flare

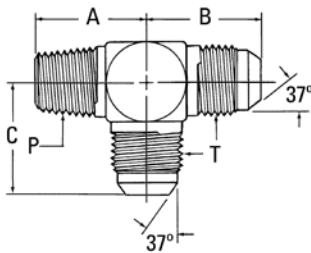

2028-(Dash size) (Ref. SAE 070424) (Formerly Weatherhead series C5755x)

Dash size	Tube O. D.		Thread P	Thread T	A		B		C	
	mm	in			mm	in	mm	in	mm	in
2-3S	4,8	0.19	1/8-27	3/8-24	18,3	0.72	21,1	0.83	21,1	0.83
2-4S	6,3	0.25	1/8-27	7/16-20	19,8	0.78	22,6	0.89	22,6	0.89
4-4S	6,3	0.25	1/4-18	7/16-20	27,7	1.09	26,7	1.05	26,7	1.05
4-5S	7,9	0.31	1/4-18	1/2-20	27,7	1.09	26,7	1.05	26,7	1.05
4-6S	9,6	0.38	1/4-18	9/16-18	27,7	1.09	26,9	1.06	26,9	1.06
6-6S	9,6	0.38	3/8-18	9/16-18	31,0	1.22	29,0	1.14	29,0	1.14
6-8S	12,7	0.50	3/8-18	3/4-16	31,0	1.22	31,8	1.25	31,8	1.25
8-8S	12,7	0.50	1/2-14	3/4-16	37,3	1.47	33,8	1.33	33,8	1.33
8-10S	16,0	0.63	1/2-14	7/8-14	37,3	1.47	36,8	1.45	36,8	1.45
8-12S	19,0	0.75	1/2-14	1 1/16-12	40,4	1.59	42,2	1.66	42,2	1.66
12-10S	16,0	0.63	3/4-14	7/8-14	40,4	1.59	39,1	1.54	39,1	1.54
12-12S	19,0	0.75	3/4-14	1 1/16-12	40,4	1.59	42,2	1.66	42,2	1.66
16-16S	25,4	1.00	1-11 1/2	1 5/16-12	50,0	1.97	46,0	1.81	46,0	1.81
20-20S	31,7	1.25	1 1/4-11 1/2	1 5/8-12	60,5	2.38	52,3	2.06	52,3	2.06
24-24S	38,1	1.50	1 1/2-11 1/2	1 7/8-12	67,1	2.64	59,2	2.33	59,2	2.33
32-32S	50,8	2.00	2-11 1/2	2 1/2-12	76,2	3.00	77,7	3.06	77,7	3.06

Pipe to SAE 37° flare

NPTF external pipe/ NPTF internal pipe/SAE 37° flare

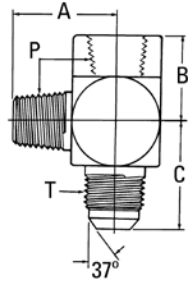

203006-(Dash size)

Dash size	Tube O. D.		Thread P	Thread T	A		B		C	
	mm	in			mm	in	mm	in	mm	in
4-6S	9,6	0.38	1/4-18	9/16-18	27,7	1.09	22,3	0.88	31,2	1.23
6-8S	12,7	0.50	3/8-18	3/4-16	31,0	1.22	25,9	1.02	36,1	1.42
8-10S	16,0	0.63	1/2-14	7/8-14	41,7	1.64	31,2	1.23	37,3	1.47
12-12S	19,0	0.75	3/4-14	1 1/16-12	40,4	1.59	34,5	1.36	48,0	1.89
16-16S	25,4	1.00	1-11 1/2	1 5/16-12	50,0	1.97	42,1	1.62	55,1	2.17
20-20S	31,7	1.25	1 1/4-11 1/2	1 5/8-12	59,2	2.33	43,2	1.70	60,5	2.38

NPTF external pipe/SAE 37° flare

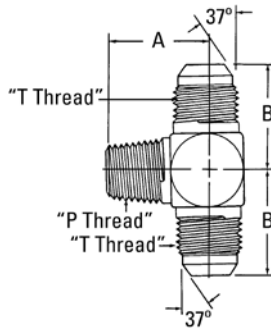

2030-(Dash size) (Ref. SAE 070425) (Formerly Weatherhead series C5605x)

Dash size	Tube O.D.		Thread P	Thread T	A		B	
	mm	in			mm	in	mm	in
2-4S	6,3	0.25	1/8-27	7/16-20	19,8	0.78	22,6	0.89
2-5S	7,9	0.31	1/8-27	1/2-20	19,8	0.78	24,1	0.95
4-4S	6,3	0.25	1/4-18	7/16-20	27,7	1.09	26,7	1.05
4-5S	7,9	0.31	1/4-18	1/2-20	27,7	1.09	26,7	1.05
4-6S	9,6	0.38	1/4-18	9/16-18	27,7	1.09	26,9	1.06
6-6S	9,6	0.38	3/8-18	9/16-18	31,0	1.22	29,0	1.14
6-8S	12,7	0.50	3/8-18	3/4-16	31,0	1.22	31,8	1.25
8-6S	9,6	0.38	1/2-14	9/16-18	37,3	1.47	31,0	1.22
8-8S	12,7	0.50	1/2-14	3/4-16	37,3	1.47	33,8	1.33
8-10S	16,0	0.63	1/2-14	7/8-14	37,3	1.47	36,8	1.45
12-12S	19,0	0.75	3/4-14	1 1/16-12	40,4	1.59	42,2	1.66
12-16S	25,4	1.00	3/4-14	1 5/16-12	45,2	1.78	46,0	1.81
16-16S	25,4	1.00	1-11 1/2	1 5/16-12	50,0	1.97	46,0	1.81
20-20S	31,7	1.25	1 1/4-11 1/2	1 5/8-12	60,5	2.38	52,3	2.06

NPTF internal pipe/SAE 37° flare

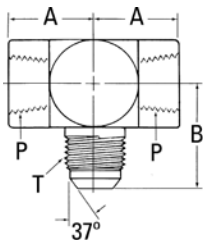

202901-(Dash size)

Dash size	Tube O.D.		Thread P	Thread T	A		B	
	mm	in			mm	in	mm	in
4-6S	9,6	0.38	1/4-18	9/16-18	22,3	0.88	31,2	1.23
12-12S	19,0	0.75	3/4-14	1 1/16-12	34,5	1.36	48,0	1.89
16-16S	25,4	1.00	1-11 1/2	1 5/16-12	42,1	1.62	55,1	2.17

NPTF internal pipe/ NPTF internal pipe/SAE 37° flare

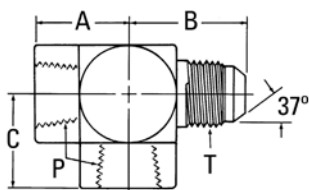

203104-(Dash size) (Ref. SAE 070427)

Dash size	Tube O.D.		Thread P	Thread T	A		B		C	
	mm	in			mm	in	mm	in	mm	in
4-6S	9,6	0.38	1/4-18	9/16-18	22,3	0.88	31,2	1.23	22,3	0.88
16-16S	25,4	1.00	1-11 1/2	1 5/16-12	42,1	1.62	55,1	2.17	42,1	1.62

Steel adapters

Pipe to SAE 37° flare

Pipe to SAE 37° flare

NPTF internal pipe/SAE 37° flare

2029-(Dash size) (Ref. SAE 070426)
(Formerly Weatherhead series C5805x)

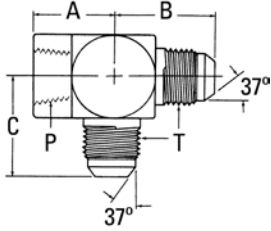

Dash size	Tube O.D.		Thread P	Thread T	A		B		C	
	mm	in			mm	in	mm	in	mm	in
2-4S	6,3	0.25	1/8-27	7/16-20	16,8	0.66	27,4	1.08	24,1	0.95
4-4S	6,3	0.25	1/4-18	7/16-20	22,4	0.88	25,4	1.00	25,4	1.00
4-6S	9,6	0.38	1/4-18	9/16-18	22,6	0.89	31,2	1.23	28,2	1.11
8-8S	12,7	0.50	1/2-14	3/4-16	31,2	1.23	36,1	1.42	35,6	1.40
12-12S	19,0	0.75	3/4-14	1 1/16-12	34,5	1.36	48,0	1.89	48,0	1.89
16-16S	25,4	1.00	1-11 1/2	1 5/16-12	41,1	1.62	55,2	2.17	53,1	2.09

NPTF internal pipe/ SAE 37° flare swivel

2031-(Dash size) (Ref. SAE 070427)
(Formerly Weatherhead series 5655x)

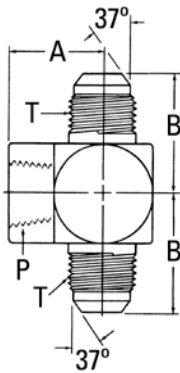

Dash size	Tube O.D.		Thread P	Thread T	A		B	
	mm	in			mm	in	mm	in
2-3S	4,8	0.19	1/8-27	3/8-24	16,8	0.66	26,2	1.03
2-4S	6,3	0.25	1/8-27	7/16-20	16,8	0.66	27,4	1.08
4-4S	6,3	0.25	1/4-18	7/16-20	22,4	0.88	31,0	1.22
4-6S	9,6	0.38	1/4-18	9/16-18	22,4	0.88	31,2	1.23
6-8S	12,7	0.50	3/8-18	3/4-16	25,9	1.02	36,1	1.42
8-8S	12,7	0.50	1/2-14	3/4-16	31,2	1.23	38,6	1.52
8-10S	16,0	0.63	1/2-14	7/8-14	31,2	1.23	41,6	1.64
12-12S	19,0	0.75	3/4-14	1 1/16-12	34,5	1.36	48,0	1.89
16-16S	25,4	1.00	1-11 1/2	1 5/16-12	41,1	1.62	53,1	2.09
32-32S	50,8	2.00	2-11 1/2	2 1/2-12	60,7	2.39	83,8	3.30

NPTF external pipe/SAE 37° flare

202003-(Dash size)

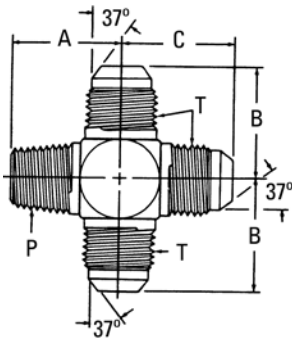

Dash size	Tube O.D.		Thread P	Thread T	A		B		C	
	mm	in			mm	in	mm	in	mm	in
6-6S	9,6	0.38	3/8-18	9/16-18	26,9	1.06	26,9	1.06	26,9	1.06

Pipe to 45° flare – Brass

NPTF external pipe/ SAE 45° flare

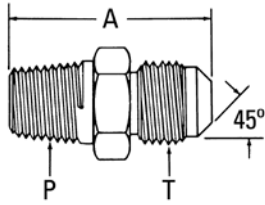

WARNING: California Proposition 65, see below.

2000-(Dash size) (Ref. SAE 010102)

Dash size	Tube O.D.		Thread P	Thread T	A	
	mm	in			mm	in
2-4B	6,3	0.25	1/8-27	7/16-20	26,9	1.06
2-5B	7,9	0.31	1/8-27	1/2-20	29,5	1.16
2-6B	9,6	0.38	1/8-27	5/8-18	31,8	1.25
4-4B	6,3	0.25	1/4-18	7/16-20	31,8	1.25
4-5B	7,9	0.31	1/4-18	1/2-20	34,0	1.34
4-6B	9,6	0.38	1/4-18	5/8-18	36,6	1.44
4-8B	12,7	0.50	1/4-18	3/4-16	41,1	1.62
6-4B	6,3	0.25	3/8-18	7/16-20	33,3	1.31
6-5B	7,9	0.31	3/8-18	1/2-20	35,1	1.38
6-6B	9,6	0.38	3/8-18	5/8-18	36,6	1.44
6-8B	12,7	0.50	3/8-18	3/4-16	41,1	1.62
6-10B	16,0	0.63	3/8-18	7/8-14	46,0	1.81
8-4B	6,3	0.25	1/2-14	7/16-20	39,6	1.56
8-6B	9,6	0.38	1/2-14	5/8-18	42,9	1.69
8-8B	12,7	0.50	1/2-14	3/4-16	46,0	1.81
8-10B	16,0	0.63	1/2-14	7/8-14	50,8	2.00
8-12B	19,0	0.75	1/2-14	1 1/16-14	55,6	2.19
12-8B	12,7	0.50	3/4-14	3/4-16	49,3	1.94
12-10B	16,0	0.63	3/4-14	7/8-14	52,3	2.06
12-12B	19,0	0.75	3/4-14	1 1/16-14	55,6	2.19

For more brass fittings see E-BRFI-MC001-E

NPTF internal pipe/ SAE 45° flare

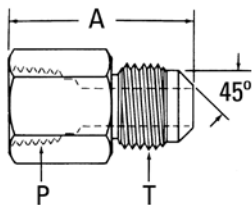

WARNING: California Proposition 65, see below.

2001-(Dash size) (Ref. SAE 010103)

Dash size	Tube O.D.		Thread P	Thread T	A	
	mm	in			mm	in
2-4B	6,3	0.25	1/8-27	7/16-20	26,9	1.06
2-5B	7,9	0.31	1/8-27	1/2-20	29,5	1.16
2-6B	6,3	0.25	1/8-27	9/16-18	28,4	1.12
4-4B	6,3	0.25	1/4-18	7/16-20	30,3	1.19
4-5B	7,9	0.31	1/4-18	1/2-20	31,8	1.25
6-4B	6,3	0.25	3/8-18	7/16-20	30,3	1.19
6-6B	9,6	0.38	3/8-18	5/8-18	33,3	1.31
6-8B	12,7	0.50	3/8-18	3/4-16	39,6	1.56
6-10B	16,0	0.63	3/8-18	7/8-14	39,6	1.56
8-6B	9,6	0.38	1/2-14	5/8-18	38,1	1.50
8-8B	12,7	0.50	1/2-14	3/4-16	41,1	1.62
8-10B	16,0	0.63	1/2-14	7/8-14	46,0	1.81
8-12B	19,0	0.75	1/2-14	1 1/16-14	50,8	2.00
12-10B	16,0	0.63	3/4-14	7/8-14	46,0	1.81
12-12B	19,0	0.75	3/4-14	1 1/16-14	49,3	1.94

CALIFORNIA PROPOSITION 65 WARNING

WARNING: This product contains lead and other chemicals which are known to the state of California to cause cancer and birth defects or other reproductive harm.

CAUTION: A Proposition 65 warning may be required for any item removed from the package for sale separately if an item is to be sold or offered for sale in California.

IT IS ILLEGAL TO USE THIS PRODUCT FOR DRINKING WATER OR OTHER POTABLE SERVICES.

CAUTION: The warning must accompany any item removed from the package for resale.

Steel adapters

Pipe to 45° flare

Pipe to 45° flare – Brass

NPTF external pipe/ SAE 45° flare

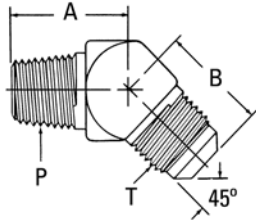

WARNING: California Proposition 65, see page 89.

2007-(Dash size) (Ref. SAE 010302)

Dash size	Tube O.D.		Thread P	Thread T	A		B	
	mm	in			mm	in	mm	in
2-4B	6,3	0.25	1/8-27	7/16-20	16,2	0.64	17,3	0.68
4-4B	6,3	0.25	1/4-18	7/16-20	20,8	0.82	17,8	0.70
4-6B	9,6	0.38	1/4-18	5/8-18	21,8	0.86	22,6	0.89
6-6B	9,6	0.38	3/8-18	5/8-18	24,1	0.95	24,6	0.97
6-8B	12,7	0.50	3/8-18	3/4-16	24,4	0.96	29,2	1.15
6-10B	16,0	0.63	3/8-18	7/8-14	24,9	0.98	31,2	1.23
8-6B	9,6	0.38	1/2-14	5/8-18	29,7	1.17	25,1	0.99
8-8B	12,7	0.50	1/2-14	3/4-16	29,7	1.17	28,5	1.12
8-10B	16,0	0.63	1/2-14	7/8-14	29,7	1.17	31,2	1.23

For more brass fittings see E-BRFI-MC001-E

NPTF internal pipe/ SAE 45° flare

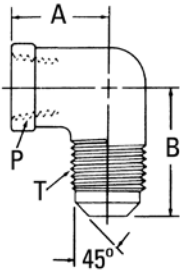

WARNING: California Proposition 65, see page 89.

2002-(Dash size) (Ref. SAE 010203)

Dash size	Tube O.D.		Thread P	Thread T	A		B	
	mm	in			mm	in	mm	in
2-4B	6,3	0.25	1/8-27	7/16-20	11,7	0.46	22,9	0.90
4-4B	6,3	0.25	1/4-18	7/16-20	17,5	0.69	25,4	0.97
4-6B	9,6	0.38	1/4-18	5/8-18	17,5	0.69	27,7	1.09
6-4B	6,3	0.25	3/8-18	7/16-20	14,5	0.57	26,2	1.03
6-6B	9,6	0.38	3/8-18	5/8-18	27,7	1.09	26,9	1.06
6-8B	12,7	0.50	3/8-18	3/4-16	28,4	1.12	32,5	1.28
6-10B	16,0	0.63	3/8-18	7/8-14	31,0	1.22	34,3	1.35
8-8B	12,7	0.50	1/2-14	3/4-16	23,9	0.94	35,1	1.38
8-10B	16,0	0.63	1/2-14	7/8-14	25,4	1.00	38,1	1.50
8-12B	19,0	0.75	1/2-14	1 1/16-14	26,9	1.06	41,4	1.63
12-12B	19,0	0.75	3/4-14	1 1/16-14	26,9	1.06	45,2	1.78

NPTF external pipe/ SAE 45° flare

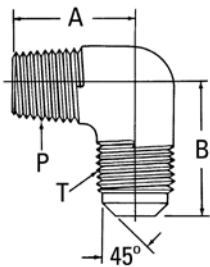

WARNING: California Proposition 65, see page 89.

2003-(Dash size) (Ref. SAE 010202)

Dash size	Tube O.D.		Thread P	Thread T	A		B	
	mm	in			mm	in	mm	in
2-4B	6,3	0.25	1/8-27	7/16-20	19,3	0.76	20,1	0.79
2-5B	7,9	0.31	1/8-27	1/2-20	19,8	0.78	23,1	0.91
2-6B	9,6	0.38	1/8-27	5/8-18	23,1	0.91	26,2	1.03
4-4B	6,3	0.25	1/4-18	7/16-20	22,4	0.88	25,1	0.99
4-5B	7,9	0.31	1/4-18	1/2-20	23,3	0.92	24,1	0.95
4-6B	9,6	0.38	1/4-18	5/8-18	26,7	1.05	24,7	0.98
4-8B	12,7	0.50	1/4-18	3/4-16	30,2	1.19	31,2	1.23
6-4B	6,3	0.25	3/8-18	7/16-20	26,2	1.03	23,9	0.94
6-5B	7,9	0.31	3/8-18	1/2-20	23,1	0.91	25,4	1.00
6-6B	9,6	0.38	3/8-18	5/8-18	27,7	1.09	26,4	1.04
6-8B	12,7	0.50	3/8-18	3/4-16	28,4	1.12	31,2	1.23
6-10B	16,0	0.63	3/8-18	7/8-14	31,0	1.22	36,1	1.42
8-6B	9,6	0.38	1/2-14	5/8-18	34,3	1.35	29,5	1.16
8-8B	12,7	0.50	1/2-14	3/4-16	31,8	1.25	33,5	1.32
8-10B	16,0	0.63	1/2-14	7/8-14	34,8	1.37	36,1	1.42
8-12B	19,0	0.75	1/2-14	1 1/16-14	37,6	1.48	41,1	1.62
12-8B	12,7	0.50	3/4-14	3/4-16	37,6	1.48	41,1	1.62
12-10B	16,0	0.63	3/4-14	7/8-14	33,3	1.31	36,3	1.43
12-12B	19,0	0.75	3/4-14	1 1/16-14	38,1	1.50	41,1	1.62

For more brass fittings see document E-BRFI-MC001-E

Pipe to SAE O-Ring boss

NPTF external pipe/SAE O-Ring boss (internal)

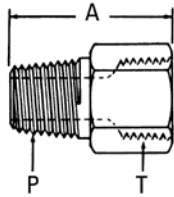
**2246-(Dash size)**

(Formerly Weatherhead series C3239x)

Dash size	Thread P	Thread T	A	
			mm	in
2-4S	1/8-27	7/16-20	27,7	1.09
2-5S	1/8-27	1/2-20	27,7	1.09
4-6S	1/4-18	9/16-18	34,5	1.36
6-6S	3/8-18	9/16-18	35,1	1.38
6-8S	3/8-18	3/4-16	36,8	1.45
8-6S	1/2-14	9/16-18	40,6	1.60
8-8S	1/2-14	3/4-16	42,4	1.67
8-10S	1/2-14	7/8-14	45,2	1.78
12-12S	3/4-14	1 1/16-12	48,8	1.92
12-14S	3/4-14	1 3/16-12	48,8	1.92
16-16S	1-11 1/2	1 5/16-12	54,1	2.13

NPSM internal pipe swivel/SAE O-Ring boss

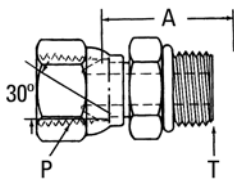
**2066-(Dash size)**

(Formerly Weatherhead series 9315x)

Dash size	Thread P	Thread T	A	
			mm	in
4-4S	1/4-18	7/16-20	26,7	1.05
4-5S	1/4-18	1/2-20	25,9	1.02
4-6S	1/4-18	9/16-18	29,0	1.14
4-8S	1/4-18	3/4-16	32,0	1.26
6-4S	3/8-18	7/16-20	26,6	1.05
6-6S	3/8-18	9/16-18	29,0	1.14
6-8S	3/8-18	3/4-16	30,3	1.19
6-10S	3/8-18	7/8-14	33,5	1.32
8-6S	1/2-14	9/16-18	31,0	1.22
8-8S	1/2-14	3/4-16	31,2	1.23
8-10S	1/2-14	7/8-14	33,0	1.30
8-12S	1/2-14	1 1/16-12	37,1	1.46
12-8S	3/4-14	3/4-16	37,8	1.49
12-10S	3/4-14	7/8-14	39,4	1.55
12-12S	3/4-14	1 1/16-12	40,1	1.58
12-14S	3/4-14	1 3/16-12	40,1	1.58
12-16S	3/4-14	1 5/16-12	47,2	1.86
16-16S	1-11 1/2	1 5/16-12	40,4	1.59
16-20S	1-11 1/2	1 5/8-12	40,4	1.59
20-20S	1 1/4-11 1/2	1 5/8-12	48,5	1.91
24-24S	1 1/2-11 1/2	1 7/8-12	51,3	2.02

Note: Available without O-Ring. Order by 206604-(dash size).

Steel adapters

Pipe to SAE O-Ring boss

Pipe to SAE O-Ring boss

NPTF internal pipe/SAE O-Ring boss

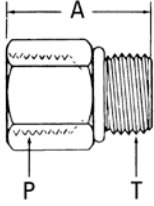

2216-(Dash size)
(Formerly Weatherhead series C3269x)

Dash size	Thread P	Thread T	A	
			mm	in
2-4S	1/8-27	7/16-20	23,4	0.92
2-5S	1/8-27	1/2-20	31,0	1.22
4-4S	1/4-18	7/16-20	30,5	1.20
4-5S	1/4-18	1/2-20	30,5	1.20
4-6S	1/4-18	9/16-18	31,5	1.24
4-8S	1/4-18	3/4-16	26,9	1.06
4-10S	1/4-18	7/8-14	20,6	0.81
6-6S	3/8-18	9/16-18	33,0	1.30
6-6S	3/8-18	9/16-18	33,0	1.30
6-8S	3/8-18	3/4-16	31,8	1.25
6-10S	3/8-18	7/8-14	31,7	1.25
8-6S	1/2-14	9/16-18	37,1	1.46
6-12S	3/8-18	1 1/16-12	34,0	1.34
8-8S	1/2-14	3/4-16	41,9	1.65
8-10S	1/2-14	7/8-14	39,1	1.54
8-12S	1/2-14	1 1/16-12	43,7	1.72
8-16S	1/2-14	1 5/16-12	25,4	1.00
12-10S	3/4-14	7/8-14	45,0	1.77
12-12S	3/4-14	1 1/16-12	42,4	1.67
12-14S	3/4-14	1 3/16-12	42,7	1.68
12-16S	3/4-14	1 5/16-12	25,4	1.00
16-16S	1-11 1/2	1 5/16-12	48,5	1.91
16-20S	1-11 1/2	1 5/8-12	25,4	1.00
20-20S	1 1/4-11 1/2	1 5/8-12	50,8	2.00
24-24S	1 1/2-11 1/2	1 7/8-12	50,8	2.00
32-32S	2-11 1/2	2 1/2-12	53,3	2.10

Note: Also available without O-Ring. Order by 2216-1-(dash size).

NPSM internal pipe swivel/SAE O-Ring boss (adj.)

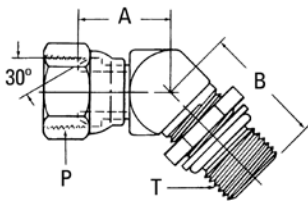

2067-(Dash size)
(Formerly Weatherhead series 9365x)

Dash size	Thread P	Thread T	A		B	
			mm	in	mm	in
4-4S	1/4-18	7/16-20	15,5	0.61	27,4	1.08
6-4S	3/8-18	7/16-18	20,1	0.72	28,0	1.10
6-6S	3/8-18	9/16-18	23,4	0.92	30,5	1.20
6-8S	3/8-18	3/4-16	23,4	0.92	33,8	1.33
8-6S	1/2-14	9/16-18	23,1	0.91	30,5	1.20
8-8S	1/2-14	3/4-16	23,1	0.91	35,3	1.39
8-10S	1/2-14	7/8-14	23,1	0.91	39,4	1.55
12-8S	3/4-14	3/4-16	27,9	1.10	36,6	1.44
12-12S	3/4-14	1 1/16-12	27,9	1.10	44,7	1.76
12-16S	3/4-14	1 5/16-12	27,9	1.10	48,0	1.89
16-16S	1-11 1/2	1 5/16-12	32,0	1.26	48,0	1.89
20-20S	1 1/4-11 1/2	1 5/8-12	30,5	1.20	48,5	1.91

Note: Available without O-Ring. Order by 2067-1-(dash size).

Pipe to SAE O-Ring boss

NPSM internal pipe swivel/SAE O-Ring boss (adj.)

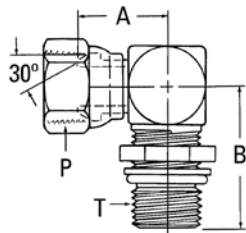

2068-(Dash size) (Formerly Weatherhead series 9515x)

Dash size	Thread P	Thread T	A		B	
			mm	in	mm	in
4-4S	1/4-18	7/16-20	23,1	0.91	29,5	1.16
4-6S	1/4-18	9/16-18	23,1	0.91	31,0	1.22
6-4S	3/8-18	7/16-20	27,7	1.09	33,8	1.33
6-6S	3/8-18	9/16-18	27,7	1.09	34,3	1.35
6-8S	3/8-18	3/4-16	27,7	1.09	37,6	1.48
6-10S	3/8-18	7/8-14	27,7	1.09	42,4	1.67
8-6S	1/2-14	9/16-18	27,4	1.08	38,4	1.51
8-8S	1/2-14	3/4-16	27,4	1.08	38,4	1.51
8-10S	1/2-14	7/8-14	27,4	1.08	42,4	1.67
8-12S	1/2-14	1 1/16-12	30,0	1.18	50,0	1.97
12-8S	3/4-14	3/4-16	33,0	1.30	41,9	1.65
12-10S	3/4-14	7/8-14	33,5	1.32	46,0	1.81
12-12S	3/4-14	1 1/16-12	34,5	1.36	50,0	1.97
12-16S	3/4-14	1 5/16-12	35,8	1.41	53,8	2.12
16-16S	1-11 1/2	1 5/16-12	38,9	1.53	53,8	2.12
20-16S	1 1/4-11 1/2	1 5/16-12	46,2	1.82	63,5	2.50
20-20S	1 1/4-11 1/2	1 5/8-12	46,2	1.82	63,5	2.50

Note: Available without O-Ring. Order by 2068-1-(dash size).

NPTF internal pipe/SAE O-Ring boss (adj.)

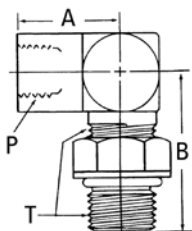

206801-(Dash size) (Formerly Weatherhead series C3459x)

Dash size	Thread P	Thread T	A		B	
			mm	in	mm	in
4-6S	1/4-18	9/16-18	22,4	0.88	34,3	1.35
6-8S	3/8-18	3/4-16	25,9	1.02	41,1	1.62
8-8S	1/2-14	3/4-16	31,2	1.23	43,9	1.73
8-10S	1/2-14	7/8-14	31,2	1.23	48,0	1.89
12-12S	3/4-14	1 1/16-12	34,5	1.36	55,2	2.17
16-16S	1-11 1/2	1 5/16-12	41,1	1.62	61,2	2.41
20-20S	1 1/4-11 1/2	1 5/8-12	43,2	1.70	63,5	2.50

Note: Available without O-Ring. Order by 206801-1-(dash size).

NPTF internal pipe/SAE O-Ring boss (adj.)

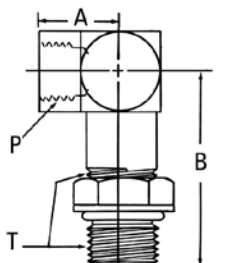

206804-(Dash size) (Formerly Weatherhead series C3469x)

Dash size	Thread P	Thread T	A		B	
			mm	in	mm	in
6-8S	3/8-18	3/4-16	25,9	1.02	75,4	2.97
8-10S	1/2-14	7/8-14	31,2	1.23	90,4	3.56
12-12S	3/4-14	1 1/16-12	34,5	1.36	104,6	4.12
16-16S	1-11 1/2	1 5/16-12	41,1	1.62	117,8	4.64

Note: Available without O-Ring. Order by 206804-1-(dash size).

Steel adapters

Pipe to braze and weld
SAE 37° flare union

Pipe to braze and weld

Braze port/ NPTF external pipe

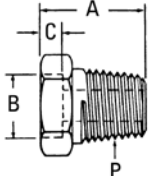

73056-(Dash size)

Dash size	Tube O.D.		Thread P	A		B		C	
	mm	in		mm	in	mm	in	mm	in
2-4S	6,3	0.25	1/8-27	16,8	0.66	6,3	0.25	4,0	0.16
2-6S	9,6	0.38	1/8-27	18,0	0.71	9,6	0.38	4,0	0.16
4-6S	9,6	0.38	1/4-18	22,5	0.89	9,6	0.38	4,0	0.16
16S	25,4	1.00	1-11 1/2	33,6	1.32	25,4	1.00	6,4	0.25

Braze port/ NPTF external pipe

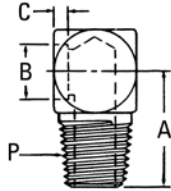

FF1159-(Dash size)

Dash size	Tube O.D.		Thread P	A		B		C	
	mm	in		mm	in	mm	in	mm	in
0406S	9,6	0.38	1/4-18	22,9	0.90	9,7	0.38	4,0	0.16
2020S	31,7	1.25	1 1/4-11 1/2	59,7	2.35	31,8	1.25	6,4	0.25

SAE 37° (JIC) flare union

Union SAE 37° flare/SAE 37° flare

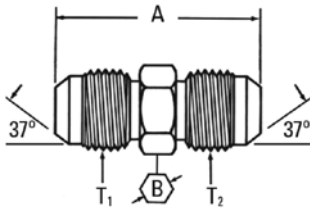

2027-(Dash size) (Ref. SAE 070101) (Formerly Weatherhead series C5305x)

Dash size	Tube O.D.		Thread T1	Thread T2	A		B	
	mm	in			mm	in	mm	in
2-2S	3,3	0.13	5/16-24	5/16-24	29,7	1.17	11,2	0.44
3-3S	4,8	0.19	3/8-24	3/8-24	31,2	1.23	11,2	0.44
4-3S	4,8	0.19	7/16-20	3/8-24	33,0	1.30	12,7	0.50
4-4S*	6,3	0.25	7/16-20	7/16-20	34,8	1.37	12,7	0.50
5-4S	6,3	0.25	1/2-20	7/16-20	34,8	1.37	14,2	0.56
5-5S	7,9	0.31	1/2-20	1/2-20	34,8	1.37	14,2	0.56
6-4S	6,3	0.25	9/16-18	7/16-20	35,6	1.40	15,7	0.62
6-5S	7,9	0.31	9/16-18	1/2-20	35,6	1.40	15,7	0.62
6-6S*	9,6	0.38	9/16-18	9/16-18	35,8	1.41	15,7	0.62
8-4S	6,3	0.25	3/4-16	7/16-20	38,4	1.51	20,6	0.81
8-6S	9,6	0.38	3/4-16	9/16-18	38,6	1.52	20,6	0.81
8-8S*	12,7	0.50	3/4-16	3/4-16	41,1	1.62	20,6	0.81
10-6S	9,6	0.38	7/8-14	9/16-18	42,7	1.68	23,9	0.94
10-8S	12,7	0.50	7/8-14	3/4-16	45,2	1.78	23,9	0.94
10-10S	16,0	0.63	7/8-14	7/8-14	47,8	1.88	23,9	0.94
12-8S	9,6	0.38	1 1/16-12	3/4-16	49,5	1.95	28,4	1.12
12-10S	15,5	0.61	1 1/16-12	7/8-14	52,1	2.05	28,4	1.12
12-12S*	19,0	0.75	1 1/16-12	1 1/16-12	54,9	2.16	28,4	1.12
14-14S	21,1	0.83	1 3/16-12	1 3/16-12	56,1	2.21	31,8	1.25
16-12S	19,0	0.75	1 5/16-12	1 1/16-12	55,9	2.20	35,1	1.38
16-16S*	25,4	1.00	1 5/16-12	1 5/16-12	57,2	2.25	35,1	1.38
20-16S	25,4	1.00	1 5/8-12	1 5/16-12	60,5	2.38	42,7	1.68
20-20S	31,7	1.25	1 5/8-12	1 5/8-12	61,7	2.43	42,9	1.69
24-24S	38,1	1.50	1 7/8-12	1 7/8-12	69,9	2.75	50,8	2.00
32-32S	50,8	2.00	2 1/2-12	2 1/2-12	86,4	3.40	66,5	2.62

* Also available in stainless steel as 259-2027-(dash size)
(Formerly Weatherhead 5317x)

SAE 37° flare union

SAE 37° flare/SAE 37° flare (large hex)

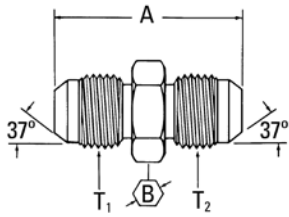

202712-(Dash size) (Ref. SAE 070119)
(Formerly Weatherhead series C5306x)

Dash size	Tube O.D.		Thread T1	Thread T2	A		B	
	mm	in			mm	in	mm	in
4-4S	6,3	0.25	7/16-20	7/16-20	34,8	1.37	17,5	0.69
6-4S	6,3	0.25	9/16-18	7/16-20	35,6	1.40	20,6	0.81
6-6S	7,9	0.31	9/16-18	9/16-18	35,6	1.40	20,6	0.81
8-8S	12,7	0.50	3/4-16	3/4-16	41,1	1.62	25,4	1.00
10-8S	12,7	0.50	7/8-14	3/4-16	45,2	1.78	28,5	1.12
10-10S	16,0	0.63	7/8-14	7/8-14	47,7	1.88	28,5	1.12
12-12S	19,0	0.75	1 1/16-12	1 1/16-12	54,9	2.16	35,1	1.38
16-16S	25,4	1.00	1 5/16-12	1 5/16-12	57,2	2.25	41,1	1.62
20-20S	31,7	1.25	1 5/8-12	1 5/8-12	61,7	2.43	47,6	1.88

SAE 37° flare bulkhead/SAE 37° flare

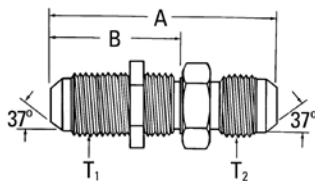

2041-(Dash size) (Ref. SAE 070601)
(Formerly Weatherhead series C5325x)

Dash size	Tube O.D.		Thread T1	Thread T2	A		B	
	mm	in			mm	in	mm	in
3-3S	4,80	0.19	3/8-24	3/8-24	48,3	1.9	29,0	1.14
4-4S	6,3	0.25	7/16-20	7/16-20	52,6	2.07	31,2	1.23
4-6S	9,6	0.38	7/16-20	9/16-18	53,3	2.10	31,2	1.23
5-5S	7,9	0.31	1/2-20	1/2-20	52,6	2.07	31,2	1.23
6-6S	9,6	0.38	9/16-18	9/16-18	55,4	2.18	33,3	1.31
8-8S*	12,7	0.50	3/4-16	3/4-16	62,0	2.44	37,3	1.47
10-10S	16,0	0.63	7/8-14	7/8-14	69,6	2.74	40,9	1.61
12-12S	19,0	0.75	1 1/16-12	1 1/16-12	78,5	3.09	45,2	1.78
12-16S	25,4	1.00	1 1/16-12	1 5/16-12	79,8	3.14	45,2	1.78
16-16S	25,4	1.00	1 5/16-12	1 5/16-12	79,8	3.14	45,2	1.78
20-20S	31,7	1.25	1 5/8-12	1 5/8-12	84,1	3.31	46,5	1.83
24-24S	38,1	1.50	1 7/8-12	1 7/8-12	89,4	3.52	46,7	1.84

Note: Available without nut. Order by 2041-1-(dash size).

* Also available in stainless steel without nut as part number 259-2041-1-(dash size). (Formerly Weatherhead 5337x)

SAE 37° flare plug

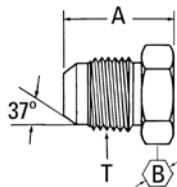

900599-(Dash size) (Ref. SAE 070109)
(Formerly Weatherhead series C5229x)

Dash size	Tube O.D.		Thread T1	A		B	
	mm	in		mm	in	mm	in
3S	4,8	0.19	3/8-24	18,5	0.73	11,2	0.44
4S	6,3	0.25	7/16-20	20,3	0.80	12,7	0.50
5S	7,9	0.31	1/2-20	20,3	0.80	14,2	0.56
6S*	9,6	0.38	9/16-18	21,3	0.84	15,7	0.62
8S	12,7	0.50	3/4-16	23,9	0.94	20,6	0.81
10S	16,0	0.63	7/8-14	27,9	1.10	23,9	0.94
12S*	19,0	0.75	1 1/16-12	32,5	1.28	28,4	1.12
14S	21,1	0.83	1 3/16-12	33,3	1.31	31,8	1.25
16S	25,4	1.00	1 5/16-12	33,8	1.33	35,1	1.38
20S	31,7	1.25	1 5/8-12	36,8	1.45	42,9	1.69
24S	38,1	1.50	1 7/8-12	41,9	1.65	50,8	2.00
32S	50,8	2.00	2 1/2-12	52,1	2.05	66,5	2.62

* Also available in stainless steel as part number 259-900599-(dash Size). (Formerly Weatherhead 5241x).

Steel adapters

SAE 37° flare union

SAE 37° flare union

Cap nut

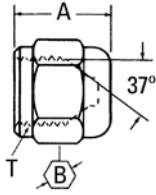

210292-(Dash size) (Ref. SAE 070112)
(Formerly Weatherhead series C5129x)

Dash size	Tube O.D.		Thread T	A		B	
	mm	in		mm	in	mm	in
3S	4,8	0.19	3/8-24	14,2	0.56	11,2	0.44
4S*	6,3	0.25	7/16-20	15,0	0.59	14,2	0.56
5S	7,9	0.31	1/2-20	15,5	0.61	15,7	0.62
6S*	9,6	0.38	9/16-18	15,7	0.62	17,6	0.69
8S*	12,7	0.50	3/4-16	19,0	0.75	22,4	0.88
10S	16,0	0.63	7/8-14	21,3	0.84	25,4	1.00
12S*	19,0	0.75	1 1/16-12	23,1	0.91	31,8	1.25
16S	25,4	1.00	1 5/16-12	25,9	1.02	38,1	1.50
20S	31,7	1.25	1 5/8-12	26,9	1.06	50,8	2.00
24S	38,1	1.50	1 7/8-12	30,3	1.19	57,2	2.25
32S	50,8	2.00	2 1/2-12	36,6	1.44	73,1	2.88

* Also available in stainless steel as stainless steel as 259-210292-(dash size)
(Formerly Weatherhaed 5141x)

SAE 37° flare (internal)/SAE 37° flare

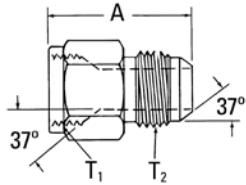

2215-(Dash size)
(Formerly Weatherhead series C5015x)

Dash size	Tube O.D.		Thread T1	Thread T2	A	
	mm	in			mm	in
4-6S	9,6	0.38	7/16-20	9/16-18	31,8	1.25
6-5S	7,9	0.31	9/16-18	1/2-20	30,0	1.18
8-10S	16,0	0.63	3/4-16	7/8-14	38,4	1.51
10-4S	6,3	0.25	7/16-20	7/8-14	35,6	1.40
10-6S	9,6	0.38	9/16-18	7/8-14	35,8	1.41
10-8S	12,7	0.50	7/8-14	3/4-16	38,9	1.53
10-12S	19,0	0.75	7/8-14	1 1/16-12	44,2	1.74
12-10S	16,0	0.63	1 1/16-12	7/8-14	43,9	1.73
12-16S	25,4	1.00	1 1/16-12	1 5/16-12	50,8	2.00
14-8S	12,7	0.50	1 3/16-12	3/4-16	42,9	1.69
16-8S	12,7	0.50	3/4-16	1 5/16-12	42,4	1.67
16-10S	16,0	0.63	7/8-14	1 5/16-12	45,2	1.78
16-20S	31,8	1.25	1 5/16-12	1 5/8-12	58,4	2.30
20-16S	25,4	1.00	1 5/8-12	1 5/16-12	50,3	1.98
24-16S	25,4	1.00	1 7/8-12	1 5/16-12	58,7	2.31
24-20S	31,8	1.25	1 7/8-12	1 5/8-12	58,4	2.30
24-32S	50,8	2.00	1 7/8-12	2 1/2-12	68,1	2.68
32-24S	38,1	1.50	1 7/8-12	2 1/2-12	64,0	2.52

SAE 37° flare union

SAE 37° flare swivel reducer/SAE 37° flare

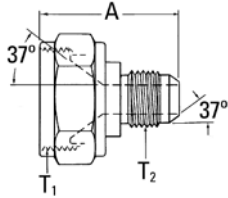

221501-(Dash size) (Ref. SAE 070123)
(Formerly Weatherhead series C5015x)

Dash size	Tube O.D.		Thread T1	Thread T2	A	
	mm	in			mm	in
6-4S	6,3	0.25	9/16-18	7/16-20	35,6	1.40
8-4S	6,3	0.25	3/4-16	7/16-20	38,1	1.50
8-6S	9,6	0.38	3/4-16	9/16-18	38,1	1.50
10-6S	9,6	0.38	7/8-14	9/16-18	41,1	1.62
12-4	6,3	0.25	1 1/16-12	7/16-20	27,7	1.09
12-6S	9,6	0.38	1 1/16-12	9/16-18	42,9	1.69
12-8S	12,7	0.50	1 1/16-12	3/4-16	45,5	1.79
16-6S	9,6	0.38	1 5/16-12	9/16-18	46,7	1.84
16-8S	12,7	0.50	1 5/16-12	3/4-16	49,3	1.94
16-10S	16,0	0.63	1 5/16-12	7/8-14	51,8	2.04
16-12S	19,0	0.75	1 5/16-12	1 1/16-12	54,6	2.15
20-12	19,0	0.75	1 5/8-12	1 1/16-12	38,1	1.50
20-16S	25,4	1.00	1 5/8-12	1 5/16-12	56,6	2.23

Note: Available without nut. Order by Part no. FF1066-(dash size).

SAE 37° flare bulkhead/SAE 37° flare

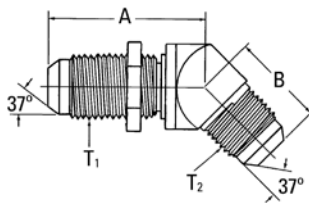

2042-(Dash size) (Ref. SAE 070801)
(Formerly Weatherhead series C5375x)

Dash size	Tube O.D.		Thread T1	Thread T2	A		B	
	mm	in			mm	in	mm	in
4-4S	6,3	0.25	7/16-20	7/16-20	38,9	1.53	18,3	0.72
5-5S	7,9	0.31	1/2-20	1/2-20	42,2	1.66	19,6	0.77
6-6S	9,6	0.38	9/16-18	9/16-18	42,4	1.67	21,1	0.83
8-8S	12,7	0.50	3/4-16	3/4-16	49,3	1.94	24,9	0.98
10-10S	16,0	0.63	7/8-14	7/8-14	55,1	2.17	28,2	1.11
12-12S	19,0	0.75	1 1/16-12	1 1/16-12	35,8	1.41	59,9	2.36
16-16S	25,4	1.00	1 5/16-12	1 5/16-12	37,3	1.47	63,5	2.58
20-20S	31,7	1.25	1 5/8-12	1 5/8-12	64,3	2.53	42,9	1.69

Note: Available without nut. Order by 2042-1-(dash size).

SAE 37° flare swivel/SAE 37° flare

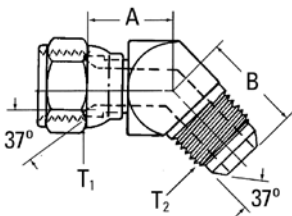

2070-(Dash size) (Ref. SAE 070321)
(Formerly Weatherhead series C5356x)

Dash size	Tube O.D.		Thread T1	Thread T2	A		B	
	mm	in			mm	in	mm	in
4-4S	6,3	0.25	7/16-20	7/16-20	15,2	0.60	18,3	0.72
5-5S	7,9	0.31	1/2-20	1/2-20	15,7	0.62	19,6	0.77
6-6S	9,6	0.38	9/16-18	9/16-18	18,8	0.74	21,1	0.83
8-8S	12,7	0.50	3/4-16	3/4-16	21,8	0.86	24,9	0.98
10-10S	16,0	0.63	7/8-14	7/8-14	23,9	0.94	28,2	1.11
12-12S	19,0	0.75	1 1/16-12	1 1/16-12	23,9	0.94	32,5	1.28
14-14S	22,3	0.88	1 3/16-12	1 3/16-12	26,4	1.04	36,8	1.45
16-16S	25,4	1.00	1 5/16-12	1 5/16-12	29,5	1.16	37,3	1.47
20-20S	31,7	1.25	1 5/8-12	1 5/8-12	35,6	1.40	40,4	1.59

Steel adapters

SAE 37° flare union

SAE 37° flare union

SAE 37° flare/SAE 37° flare

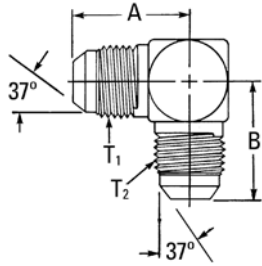

2039-(Dash size) (Ref. SAE 070201)
(Formerly Weatherhead series C5505x)

Dash size	Tube O.D.		Thread T1	Thread T2	A		B	
	mm	in			mm	in	mm	in
4-4S	6,3	0.25	7/16-20	7/16-20	22,6	0.89	22,6	0.89
5-5S	7,9	0.31	1/2-20	1/2-20	24,1	0.95	24,1	0.95
6-6S	9,6	0.38	9/16-18	9/16-18	26,9	1.06	26,9	1.06
8-6S	9,6	0.38	3/4-16	9/16-16	31,8	1.25	29,0	1.14
8-8S	12,7	0.50	3/4-16	3/4-16	31,8	1.25	31,8	1.25
10-10S	16,0	0.63	7/8-14	7/8-14	36,8	1.45	36,8	1.45
12-12S	19,0	0.75	1 1/16-12	1 1/16-12	42,2	1.66	42,2	1.66
16-12S	19,0	0.75	1 5/16-12	1 1/16-12	46,0	1.81	44,7	1.76
16-16S	25,4	1.00	1 5/16-12	1 5/16-12	46,0	1.81	46,0	1.81
20-20S	31,7	1.25	1 5/8-12	1 5/8-12	52,3	2.06	52,3	2.06
24-24S	38,1	1.50	1 7/8-12	1 7/8-12	59,2	2.33	59,2	2.33
32-32S	50,8	2.00	2 1/2-12	2 1/2-12	77,7	3.06	77,7	3.06

SAE 37° flare bulkhead/SAE 37° flare

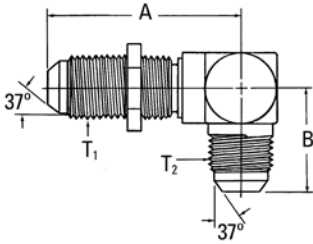

2043-(Dash size) (Ref. SAE 070701)
(Formerly Weatherhead series C5525x)

Dash size	Tube O.D.		Thread T1	Thread T2	A		B	
	mm	in			mm	in	mm	in
4-4S	6,3	0.25	7/16-20	7/16-20	40,4	1.59	24,6	0.97
5-5S	7,9	0.31	1/2-20	1/2-20	43,7	1.72	26,9	1.06
6-6S	9,6	0.38	9/16-18	9/16-18	46,0	1.81	27,7	1.09
8-8S	12,7	0.50	3/4-16	3/4-16	53,6	2.11	34,5	1.36
10-10S	16,0	0.63	7/8-14	7/8-14	60,7	2.39	39,6	1.56
12-12S	19,0	0.75	1 1/16-12	1 1/16-12	67,8	2.67	45,2	1.78
16-16S	25,4	1.00	1 5/16-12	1 5/16-12	71,1	2.80	49,3	1.94

SAE 37° flare swivel/SAE 37° flare

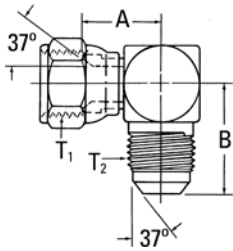

2071-(Dash size) (Ref. SAE 070221)
(Formerly Weatherhead series C5506x)

Dash size	Tube O.D.		Thread T1	Thread T2	A		B	
	mm	in			mm	in	mm	in
4-4S*	6,3	0.25	7/16-20	7/16-20	16,8	0.66	22,6	0.89
4-6S	9,6	0.38	7/16-20	9/16-18	20,8	0.82	26,9	1.06
5-5S	7,9	0.31	1/2-20	1/2-20	17,3	0.68	24,1	0.95
6-4S	6,3	0.25	9/16-18	7/16-20	22,4	0.88	26,7	1.05
6-6S*	9,6	0.38	9/16-18	9/16-18	22,4	0.88	26,9	1.06
8-6S	9,6	0.38	3/4-16	9/16-18	24,4	0.96	29,0	1.14
8-8S	12,7	0.50	3/4-16	3/4-16	24,4	0.96	31,8	1.25
8-10S	16,0	0.63	3/4-16	7/8-14	25,4	1.00	36,8	1.45
10-8S	12,7	0.50	7/8-14	3/4-16	28,4	1.12	33,8	1.33
10-10S	16,0	0.63	7/8-14	7/8-14	28,4	1.12	36,8	1.45
12-12S	19,0	0.75	1 1/16-12	1 1/16-12	30,2	1.19	42,2	1.66
14-14S	22,3	0.88	1 3/16-12	1 3/16-12	30,5	1.20	45,7	1.80
16-16S	25,4	1.00	1 5/16-12	1 5/16-12	35,8	1.41	46,0	1.81
20-20S	31,7	1.25	1 5/8-12	1 5/8-12	42,7	1.68	52,3	2.06
24-24S	38,1	1.50	1 7/8-12	1 7/8-12	47,2	1.86	59,2	2.33
32-32S	50,8	2.00	2 1/2-12	2 1/2-12	62,0	2.44	77,7	3.06

* Also available in stainless steel as part number 259-2071-(dash size).
(Formerly Weatherhead 5518x)

SAE 37° flare union

SAE 37° flare swivel/SAE 37° flare

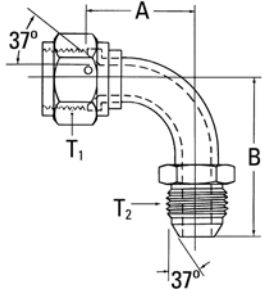

FF5163-(Dash size)

Dash size	Tube O.D.		Thread T1	Thread T2	A		B	
	mm	in			mm	in	mm	in
0808S	12,7	0.50	3/4-16	3/4-16	47,5	1.87	54,9	2.16
1212S	19,0	0.75	1 1/16-12	1 1/16-12	59,7	2.35	71,4	2.81
1616S	25,4	1.00	1 5/16-12	1 5/16-12	77,2	3.04	86,6	3.41
2020S	31,7	1.25	1 5/8-12	1 5/8-12	86,4	3.40	94,2	3.71
2424S	38,1	1.50	1 7/8-12	1 7/8-12	100,3	3.95	110,0	4.33

SAE 37° flare swivel/SAE 37° flare

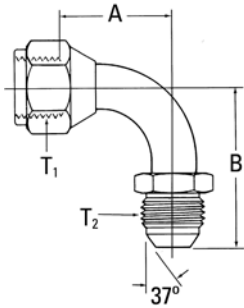

500454-(Dash size)

Dash size	Tube O.D.		Thread T1	Thread T2	A		B	
	mm	in			mm	in	mm	in
4S	6,3	0.25	7/16-20	7/16-20	17,3	0.68	28,5	1.12
6S	9,6	0.38	9/16-18	9/16-18	21,6	0.85	33,3	1.31
8S	12,7	0.50	3/4-16	3/4-16	27,7	1.09	42,2	1.66
10S	16,0	0.63	7/8-14	7/8-14	31,2	1.23	46,2	1.82
12S	19,0	0.75	1 1/16-12	1 1/16-12	46,2	1.82	63,2	2.49
16S	25,4	1.00	1 5/16-12	1 5/16-12	60,7	2.39	70,9	2.79
20S	31,7	1.25	1 5/8-12	1 5/8-12	69,8	2.75	79,7	3.14

SAE 37° flare swivel/SAE 37° flare

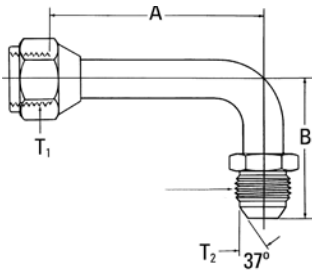

504095-(Dash size)

Dash size	Tube O.D.		Thread T1	Thread T2	A		B	
	mm	in			mm	in	mm	in
4S	6,3	0.25	7/16-20	7/16-20	45,7	1.80	28,5	1.12
5S	7,9	0.31	1/2-20	1/2-20	44,9	1.77	31,5	1.24
6S	9,6	0.38	9/16-18	9/16-18	55,4	2.18	33,3	1.31
8S	12,7	0.50	3/4-16	3/4-16	61,7	2.43	45,2	1.78
10S	16,0	0.63	7/8-14	7/8-14	65,3	2.57	52,6	2.07
12S	19,0	0.75	1 1/16-12	1 1/16-12	94,7	3.73	63,2	2.49
16S	25,4	1.00	1 5/16-12	1 5/16-12	116,3	4.58	70,9	2.79
20S	31,7	1.25	1 5/8-12	1 5/8-12	140,5	5.53	79,7	3.14

Steel adapters

SAE 37° flare union

SAE 37° flare union

SAE 37° flare swivel/SAE 37° flare

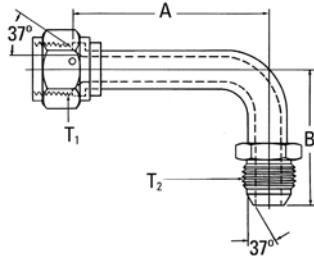

FF5164-(Dash size)

Dash size	Tube O.D.		Thread T1	Thread T2	A		B	
	mm	in			mm	in	mm	in
0808S	12,7	0.50	3/4-16	3/4-16	84,8	3.34	54,9	2.16
1212S	19,0	0.75	1 1/16-12	1 1/16-12	112,0	4.41	71,4	2.81
1616S	25,4	1.00	1 5/16-12	1 5/16-12	133,1	5.24	86,6	3.41
2020S	31,7	1.25	1 5/8-12	1 5/8-12	164,6	6.48	94,2	3.71

SAE 37° flare/SAE 37° flare/SAE 37° flare

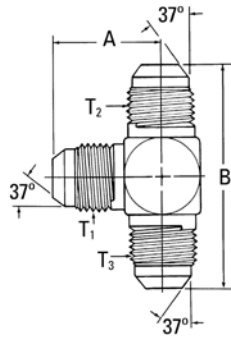

2033-(Dash size) (Ref. SAE 070401) (Formerly Weatherhead series C5705x)

Dash size	Tube O.D.		Thread T	Thread T2	Thread T3	A		B	
	mm	in				mm	in	mm	in
4-4S	6,3	0.25	7/16-20	7/16-20	7/16-20	22,6	0.89	45,2	1.78
5-5S	7,9	0.31	1/2-20	1/2-20	1/2-20	24,1	0.95	48,3	1.90
6-6S	9,6	0.38	9/16-18	9/16-18	9/16-18	26,9	1.06	53,8	2.12
8-6-6S	9,6	0.38	3/4-16	9/16-18	9/16-18	31,8	1.25	57,9	2.28
8-8S	12,7	0.50	3/4-16	3/4-16	3/4-16	31,8	1.25	63,5	2.50
8-12-12S	19,0	0.75	3/4-16	1 1/16-12	1 1/16-12	36,1	1.42	84,3	3.32
10-10S	16,0	0.63	7/8-14	7/8-14	7/8-14	36,8	1.45	73,7	2.90
12-12S	19,0	0.75	1 1/16-12	1 1/16-12	1 1/16-12	42,2	1.66	84,3	3.32
12-12-16S	19,0	0.75	1 1/16-12	1 1/16-12	1 5/16-12	44,7	1.76	92,7	3.65
16-16S	25,4	1.00	1 5/16-12	1 5/16-12	1 5/16-12	46,0	1.81	91,9	3.62
16-16-20S	31,7	1.25	1 5/16-12	1 5/16-12	1 5/8-12	50,8	2.00	103,1	4.06
20-16-16S	25,4	1.00	1 5/8-12	1 5/16-12	1 5/16-12	52,3	2.06	102,1	4.02
20-20S	31,7	1.25	1 5/8-12	1 5/8-12	1 5/8-12	52,3	2.06	104,6	4.12
24-24S	38,1	1.50	1 7/8-12	1 7/8-12	1 7/8-12	59,2	2.33	118,4	4.66

SAE 37° flare bulkhead/SAE 37° flare

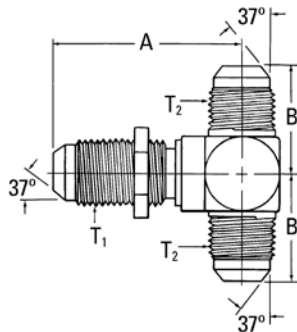

203002-(Dash size) (Ref. SAE 070959) (Formerly Weatherhead series C5725x)

Dash size	Tube O.D.		Thread T	Thread T2	A		B	
	mm	in			mm	in	mm	in
4-4S	6,3	0.25	7/16-20	7/16-20	40,4	1.59	24,6	0.97
5-5S	7,9	0.31	1/2-20	1/2-20	43,7	1.72	26,9	1.06
6-6S	9,6	0.38	9/16-18	9/16-18	46,0	1.81	27,7	1.09
8-8S	12,7	0.50	3/4-16	3/4-16	53,6	2.11	34,5	1.36
10-10S	16,0	0.63	7/8-14	7/8-14	60,7	2.39	39,6	1.56
12-12S	19,0	0.75	1 1/16-12	1 1/16-12	67,8	2.67	45,2	1.78
16-16S	25,4	1.00	1 5/16-12	1 5/16-12	71,1	2.80	49,3	1.94

Note: Available without nut. Order by 203002-1-(dash size).

SAE 37° flare union

SAE 37° flare bulkhead/SAE 37° flare

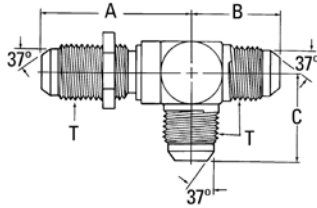

203008-(Dash size) (Ref. SAE 070958)

Dash size	Tube O.D.		Thread T	A		B		C	
	mm	in		mm	in	mm	in	mm	in
6-6S	9,6	0.38	9/16-18	46,0	1.81	27,7	1.09	27,7	1.09
8-8S	12,7	0.50	3/4-16	53,6	2.11	34,5	1.36	34,5	1.36
12-12S	19,0	0.75	1 1/16-12	67,8	2.67	45,2	1.78	45,2	1.78
16-16S	25,4	1.00	1 5/16-12	71,1	2.80	49,3	1.94	49,3	1.94
20-20S	31,7	1.25	1 5/8-12	79,2	3.12	55,1	2.17	55,1	2.17

SAE 37° flare swivel/SAE 37° flare

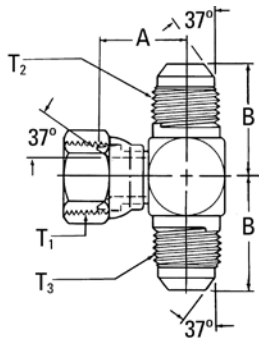

203101-(Dash size) (Ref. SAE 070433)
(Formerly Weatherhead series C5707x)

Dash size	Tube O.D.		Thread T	Thread T2	Thread T3	A		B	
	mm	in				mm	in	mm	in
4-4S	6,3	0.25	7/16-20	7/16-20	7/16-20	16,8	0.66	22,6	0.89
5-5S	7,9	0.31	1/2-20	1/2-20	1/2-20	17,3	0.68	24,1	0.95
6-5S	7,9	0.31	9/16-18	9/16-18	9/16-18	22,4	0.88	26,7	1.05
6-6S	9,6	0.38	9/16-18	9/16-18	9/16-18	22,4	0.88	26,9	1.06
8-8S	12,7	0.50	3/4-16	3/4-16	3/4-16	24,4	0.96	31,8	1.25
10-10S	16,0	0.63	7/8-14	7/8-14	7/8-14	28,4	1.12	36,8	1.45
12-12S	19,0	0.75	1 1/16-12	1 1/16-12	1 1/16-12	30,0	1.18	42,2	1.66
16-16S	25,4	1.00	1 5/16-12	1 5/16-12	1 5/16-12	35,6	1.40	46,0	1.81
20-20S	31,7	1.25	1 5/8-12	1 5/8-12	1 5/8-12	42,7	1.68	52,3	2.06

SAE 37° flare bulkhead/SAE 37° flare

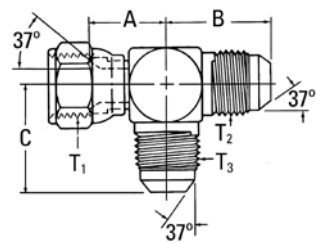

203102-(Dash size) (Ref. SAE 070432)
(Formerly Weatherhead series C5706x)

Dash size	Tube O.D.		Thread T	Thread T2	Thread T3	A		B		C	
	mm	in				mm	in	mm	in	mm	in
4-4S	6,3	0.25	7/16-20	7/16-20	7/16-20	16,8	0.66	22,6	0.89	22,6	0.89
5-5S	7,9	0.31	1/2-20	1/2-20	1/2-20	17,5	0.69	24,1	0.95	24,1	0.95
6-6S	9,6	0.38	9/16-18	9/16-18	9/16-18	22,4	0.88	26,9	1.06	26,9	1.06
8-8S	12,7	0.50	3/4-16	3/4-16	3/4-16	24,4	0.96	31,8	1.25	31,8	1.25
10-10S	16,0	0.63	7/8-14	7/8-14	7/8-14	28,4	1.12	36,8	1.45	36,8	1.45
12-12S	19,0	0.75	1 1/16-12	1 1/16-12	1 1/16-12	30,2	1.19	42,2	1.66	42,2	1.66
16-16S	25,4	1.00	1 5/16-12	1 5/16-12	1 5/16-12	35,8	1.41	46,0	1.81	46,0	1.81
20-20S	31,7	1.25	1 5/8-12	1 5/8-12	1 5/8-12	42,7	1.68	52,3	2.06	52,3	2.06

Steel adapters

SAE 37° flare union

SAE 37° flare union

SAE 37° flare

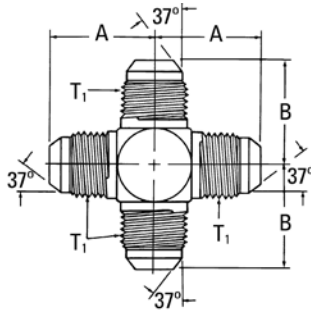

2020-(Dash size) (Ref. SAE 070501)
(Formerly Weatherhead series C5955x)

Dash size	Tube O.D.		Thread T	A		B	
	mm	in		mm	in	mm	in
4-4S	6,3	0.25	7/16-20	22,6	0.89	22,6	0.89
6-6S	9,6	0.38	9/16-18	26,9	1.06	26,9	1.06
8-8S	12,7	0.50	3/4-16	31,8	1.25	31,8	1.25
12-12S	19,0	0.75	1 1/16-12	42,2	1.66	44,2	1.74
16-16S	25,4	1.00	1 5/16-12	46,0	1.81	49,8	1.96

Bulkhead lock nut

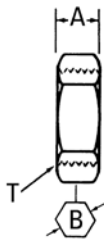

210212-(Dash size) (Ref. SAE 070118)
(Formerly Weatherhead series C5924x)

Dash size	Tube O.D.		Thread T	A		B	
	mm	in		mm	in	mm	in
4S	6,3	0.25	7/16-20	6,4	0.25	17,6	0.69
5S	7,9	0.31	1/2-20	6,4	0.25	19,0	0.75
6S*	9,6	0.38	9/16-18	6,8	0.27	20,6	0.81
8S*	12,7	0.50	3/4-16	7,9	0.31	25,4	1.00
10S	16,0	0.63	7/8-14	9,1	0.36	28,5	1.12
12S*	19,0	0.75	1 1/16-12	10,4	0.41	35,1	1.38
16S	25,4	1.00	1 5/16-12	10,4	0.41	41,1	1.62
20S	31,7	1.25	1 5/8-12	10,4	0.41	47,7	1.88
24S	38,1	1.50	1 7/8-12	10,4	0.41	53,9	2.12

* Also available in stainless steel as part number 259-210212-(dash size).
(Formerly Weatherhead 7936x).

SAE 45° flare union

SAE 45° flare bulkhead/45° flare

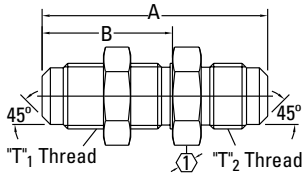

2056-(Dash size)

Dash size	Tube O.D.		Thread T1	Thread T2	A		B		1	
	mm	in			mm	in	mm	in	mm	in
10-10S	16,0	0.63	7/8-14	7/8-14	75,9	2.99	43,9	1.73	28,5	1.12

Note: Available without nut. Order by 2056-1-(dash size).

45° flare/45° flare

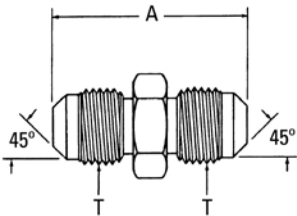

2060-(Dash size) (Ref. SAE 010101)

Dash size	Tube O.D.		Thread T	A	
	mm	in		mm	in
4-4B	6,3	0.25	7/16-20	30,3	1.19
5-5B	7,9	0.31	1/2-20	34,0	1.34
6-6B	9,6	0.38	5/8-18	38,1	1.50
8-8B	12,7	0.50	3/4-16	46,0	1.81
10-10B	16,0	0.63	7/8-14	53,9	2.12
12-12B	19,0	0.75	1 1/16-14	62,0	2.44

WARNING: California Proposition 65, see page 89.

45° swivel elbow female 45° SAE /male 45° SAE (Steel)

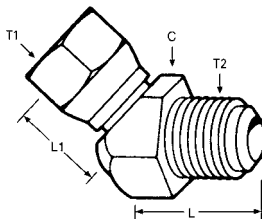

FF4174-(Dash size) (Formerly Weatherhead series 9154x)

Dash size	Tube O.D.		Hex C		L		L1		T1	T2
	mm	in	mm	in	mm	in	mm	in		
0606S	9,7	.38	19,0	.75	35,6	1.40	10,9	.43	5/8-18	5/8-18
0808S	12,7	.50	25,4	1.00	44,7	1.76	15,2	.60	3/4-16	3/4-16
1010S	15,9	.63	31,8	1.25	48,8	1.92	16,4	.65	7/8-14	7/8-14

Steel adapters

SAE O-Ring boss to SAE 37° flare

SAE O-Ring boss to SAE 37° flare

SAE O-Ring boss/SAE 37° flare

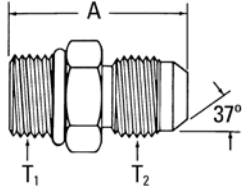

202702-(Dash size) (Ref. SAE 070120)
(Formerly Weatherhead series C5315x)

Dash size	Tube O.D.		Thread T1	Thread T2	A	
	mm	in			mm	in
2-2S	3,3	0.13	5/16-24	5/16-24	26,9	1.06
3-3S	4,8	0.19	3/8-24	3/8-24	27,9	1.10
4-4S*	6,3	0.25	7/16-20	7/16-20	31,2	1.23
4-5S	7,9	0.31	7/16-20	1/2-20	31,2	1.23
4-6S	9,6	0.38	7/16-20	9/16-18	32,3	1.27
4-8S	12,7	0.50	7/16-20	3/4-16	37,8	1.49
5-4S	6,3	0.25	1/2-20	7/16-20	31,2	1.23
5-5S	7,9	0.31	1/2-20	1/2-20	31,2	1.23
5-6S	9,6	0.38	1/2-20	9/16-18	32,3	1.27
6-4S	6,3	0.25	9/16-18	7/16-20	32,8	1.29
6-5S	7,9	0.31	9/16-18	1/2-20	32,8	1.29
6-6S*	9,6	0.38	9/16-18	9/16-18	33,0	1.30
6-8S	12,7	0.50	9/16-18	3/4-16	36,6	1.44
6-10S	16,0	0.63	9/16-18	7/8-14	43,4	1.71
8-4S	6,3	0.25	3/4-16	7/16-20	34,8	1.37
8-5S	7,9	0.31	3/4-16	1/2-20	34,8	1.37
8-6S*	9,6	0.38	3/4-16	9/16-18	35,1	1.38
8-8S*	12,7	0.50	3/4-16	3/4-16	37,6	1.48
8-10S	16,0	0.63	3/4-16	7/8-14	41,7	1.64
8-12S	19,0	0.75	3/4-16	1 1/16-12	49,3	1.94
10-4S	6,3	0.25	7/8-14	7/16-20	37,8	1.49
10-6S	9,6	0.38	7/8-14	9/16-18	38,1	1.50
10-8S	12,7	0.50	7/8-14	3/4-16	40,6	1.60
10-10S	16,0	0.63	7/8-14	7/8-14	43,2	1.70
10-12S	19,0	0.75	7/8-14	1 1/16-12	47,8	1.88
10-16S	25,4	1.00	7/8-14	1 5/16-12	52,6	2.07
12-6S	9,6	0.38	1 1/16-12	9/16-18	42,2	1.66
12-8S	12,7	0.50	1 1/16-12	3/4-16	44,7	1.76
12-10S	16,0	0.63	1 1/16-12	7/8-14	47,2	1.86
12-12S*	19,0	0.75	1 1/16-12	1 1/16-12	50,0	1.97
12-14S	22,3	0.88	1 1/16-12	1 3/16-12	50,5	1.99
12-16S	25,4	1.00	1 1/16-12	1 5/16-12	51,8	2.04
12-20S	31,7	1.25	1 1/16-12	1 5/8-12	58,4	2.30
14-10S	16,0	0.63	1 3/16-12	7/8-14	47,2	1.86
14-12S	19,0	0.75	1 3/16-12	1 1/16-12	49,8	1.96
14-14S	22,3	0.88	1 3/16-12	1 3/16-12	50,5	1.99
14-16S	25,4	1.00	1 3/16-12	1 5/16-12	51,8	2.04
16-8S*	12,7	0.50	1 5/16-12	3/4-16	45,5	1.79
16-10S	16,0	0.63	1 5/16-12	7/8-14	48,0	1.89
16-12S	19,0	0.75	1 5/16-12	1 1/16-12	50,5	1.99
16-16S*	25,4	1.00	1 5/16-12	1 5/16-12	51,8	2.04
16-20S	31,7	1.25	1 5/16-12	1 5/8-12	59,2	2.33
20-12S	19,0	0.75	1 5/8-12	1 1/16-12	52,8	2.08

Note: Also available in stainless steel without O-ring, order 259-202701-(Dash size).

*Also available in stainless steel as 259-202702-(dash size). (Formerly Weatherhead part number 5327x)

(continued next page)

SAE O-Ring boss to SAE 37° flare

SAE O-Ring boss/SAE 37° flare

(continued from previous page)

202702-(Dash size) Continued (Ref. SAE 070120)
(Formerly Weatherhead series C5315x)

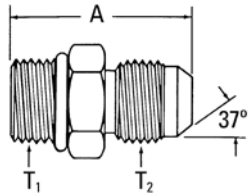

Dash size	Tube O.D.		Thread T1	Thread T2	A	
	mm	in			mm	in
20-16S	25,4	1.00	1 5/8-12	1 5/16-12	53,8	2.12
20-20S	31,7	1.25	1 5/8-12	1 5/8-12	55,1	2.17
20-24S	38,1	1.50	1 5/8-12	1 7/8-12	64,3	2.53
24-16S	25,4	1.00	1 7/8-12	1 5/16-12	55,9	2.20
24-20S	31,7	1.25	1 7/8-12	1 5/8-12	56,9	2.24
24-24S	38,1	1.50	1 7/8-12	1 7/8-12	60,2	2.37
24-32S	50,8	2.00	1 7/8-12	2 1/2-12	74,7	2.94
32-32S	50,8	2.00	2 1/2-12	2 1/2-12	70,6	2.78

Note: Also available in stainless steel without O-ring, order 259-202701-(dash size).

*Also available in stainless steel as 259-202702-(dash size).

(Formerly Weatherhead part number 5327x)

SAE O-Ring boss/SAE 37° flare

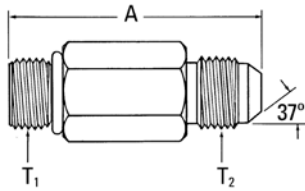

Straight thread O-ring extended connector

202713-(Dash size) (Ref. SAE 070122)
(Formerly Weatherhead series C5316x)

Dash size	Tube O.D.		Thread T1	Thread T2	A	
	mm	in			mm	in
4-4S	6,3	0.25	7/16-20	7/16-20	52,8	2.08
6-6S	9,6	0.38	9/16-18	9/16-18	58,7	2.31
6-8S	12,7	0.50	9/16-18	3/4-16	60,5	2.38
8-8S	12,7	0.50	3/4-16	3/4-16	68,6	2.70
10-10S	16,0	0.63	7/8-14	7/8-14	77,2	3.04
12-12S	19,0	0.75	1 1/16-12	1 1/16-12	91,7	3.61
16-16S	25,4	1.00	1 5/16-12	1 5/16-12	101,1	3.98

SAE O-Ring boss/SAE 37° flare swivel

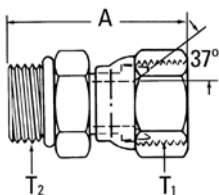

2266-(Dash size)
(Formerly Weatherhead series C5216x)

Dash size	Tube O.D.		Thread T1	Thread T2	A	
	mm	in			mm	in
4-4S	6,4	0.25	7/16-20	7/16-20	32,6	1.28
6-4S	6,3	.025	7/16-20	9/16-18	33,5	1.32
6-6S	9,6	0.38	9/16-18	9/16-18	35,6	1.40
6-8S	12,7	0.50	3/4-16	9/16-18	41,4	1.63
8-6S	9,6	0.38	9/16-18	3/4-16	36,8	1.45
8-8S	12,7	0.50	3/4-16	3/4-16	39,4	1.55
10-10S	16,0	0.63	7/8-14	7/8-14	43,7	1.72
12-12S	19,0	0.75	1 1/16-12	1 1/16-12	48,3	1.90
12-16S	19,0	0.75	1 5/16-12	1 1/16-12	56,6	2.23
16-16S	25,4	1.00	1 5/16-12	1 5/16-12	53,6	2.11
20-20S	31,7	1.25	1 5/8-12	1 5/8-12	64,5	2.54
24-24S	38,1	1.50	1 7/8-12	1 7/8-12	68,3	2.69

Steel adapters

SAE O-Ring boss to SAE 37° flare

SAE O-Ring boss to SAE 37° flare

SAE O-Ring boss (adj.)/SAE 37° flare

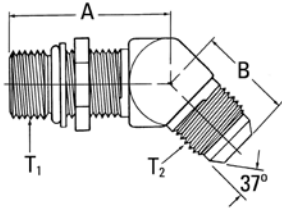

2061-(Dash size) (Ref. SAE 070320)
(Formerly Weatherhead series C5365x)

Dash size	Tube O.D.		Thread T1	Thread T2	A		B	
	mm	in			mm	in	mm	in
4-4S	6,3	0.25	7/16-20	7/16-20	26,7	1.05	18,3	0.72
5-5S	7,9	0.31	1/2-20	1/2-20	26,7	1.05	19,6	0.77
6-4S	6,3	0.25	9/16-18	7/16-20	29,0	1.14	20,8	0.82
6-6S	9,6	0.38	9/16-18	9/16-18	29,0	1.14	21,1	0.83
6-8S	12,7	0.50	9/16-18	3/4-16	30,5	1.20	24,9	0.98
8-6S	9,6	0.38	3/4-16	9/16-18	33,0	1.30	22,1	0.87
8-8S	12,7	0.50	3/4-16	3/4-16	33,0	1.30	24,9	0.98
8-10S	16,0	0.63	3/4-16	7/8-14	34,5	1.36	28,2	1.11
10-8S	12,7	0.50	7/8-14	3/4-16	38,6	1.52	25,1	0.99
10-10S	16,0	0.63	7/8-14	7/8-14	38,6	1.52	28,2	1.11
10-12S	19,0	0.75	7/8-14	1 1/16-12	39,9	1.57	32,5	1.28
12-8S	12,7	0.50	1 1/16-12	3/4-16	43,9	1.73	26,4	1.04
12-10S	16,0	0.63	1 1/16-12	7/8-14	43,9	1.73	29,5	1.16
12-12S	19,0	0.75	1 1/16-12	1 1/16-12	43,9	1.73	32,5	1.28
12-16S	25,4	1.00	1 1/16-12	1 5/16-12	47,2	1.86	37,3	1.47
14-14S	22,3	0.88	1 3/16-12	1 3/16-12	47,2	1.86	36,8	1.45
16-12S	19,0	0.75	1 5/16-12	1 1/16-12	47,2	1.86	36,1	1.42
16-16S	25,4	1.00	1 5/16-12	1 5/16-12	47,2	1.86	37,3	1.47
16-20S	31,7	1.25	1 5/16-12	1 5/8-12	48,5	1.91	40,4	1.59
20-16S	25,4	1.00	1 5/8-12	1 5/16-12	48,5	1.91	39,1	1.54
20-20S	31,7	1.25	1 5/8-12	1 5/8-12	48,5	1.91	40,4	1.59

SAE O-Ring flare (adj.)/SAE 37° flare - Long

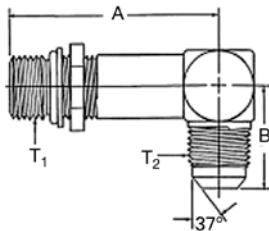

FF3910-(Dash size)
(Formerly Weatherhead series C5515xL)

Dash size	Tube O.D.		Thread T1	Thread T2	A		B	
	mm	in			mm	in	mm	in
6-6S	9,6	0.38	9/16-18	9/16-18	42,2	1.66	26,9	1.06
8-8S	12,7	0.50	3/4-16	3/4-16	45,9	1.81	31,8	1.25
12-12S	19,0	0.75	1 1/16-12	1 1/16-12	62,7	2.47	42,2	1.66

SAE O-Ring flare (adj.)/SAE 37° flare - Extra long

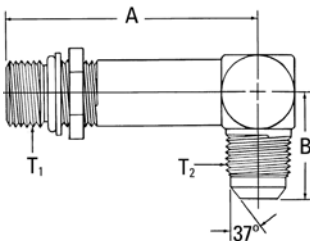

206209-(Dash size)
(Formerly Weatherhead series C5515xLL)

Dash size	Tube O.D.		Thread T1	Thread T2	A		B	
	mm	in			mm	in	mm	in
4-4S	6,3	0.25	7/16-20	7/16-20	43,9	1.73	22,6	0.89
6-6S	9,6	0.38	9/16-18	9/16-18	52,8	2.08	26,9	1.06
8-8S	12,7	0.50	3/4-16	3/4-16	63,0	2.48	31,8	1.25
8-10S	16,0	0.63	3/4-16	7/8-14	64,0	2.52	36,8	1.45
10-10S	16,0	0.63	7/8-14	7/8-14	73,4	2.89	36,8	1.45
12-12S	19,0	0.75	1 1/16-12	1 1/16-12	84,8	3.34	42,2	1.66
16-16S	25,4	1.00	1 5/16-12	1 5/16-12	94,5	3.72	46,0	1.81

SAE O-Ring boss to SAE 37° flare

SAE O-Ring boss (adj.)/SAE 37° flare

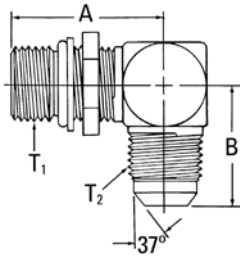

2062-(Dash size) (Ref. SAE 070220)
(Formerly Weatherhead series C5515x)

Dash size	Tube O.D.		Thread T1	Thread T2	A		B	
	mm	in			mm	in	mm	in
4-4S	6,3	0.25	7/16-20	7/16-20	26,2	1.03	22,6	0.89
4-5S	7,9	0.31	7/16-20	1/2-20	28,7	1.13	24,1	0.95
4-6S	9,6	0.38	7/16-20	9/16-18	30,2	1.19	26,9	1.06
5-4S	6,3	0.25	1/2-20	7/16-20	28,7	1.13	24,1	0.95
5-5S	7,9	0.31	1/2-20	1/2-20	28,7	1.13	24,1	0.95
5-6S	9,6	0.38	1/2-20	9/16-18	30,2	1.19	26,9	1.06
6-4S	6,3	0.25	9/16-18	7/16-20	31,8	1.25	26,7	1.05
6-5S	7,9	0.31	9/16-18	1/2-20	31,8	1.25	26,7	1.05
6-6S	9,6	0.38	9/16-18	9/16-18	31,8	1.25	26,9	1.06
6-8S	12,7	0.50	9/16-18	3/4-16	33,5	1.32	31,8	1.25
8-6S	9,6	0.38	3/4-16	9/16-18	36,8	1.45	29,0	1.14
8-8S	12,7	0.50	3/4-16	3/4-16	36,8	1.45	31,8	1.25
8-10S	16,0	0.63	3/4-16	7/8-14	39,1	1.54	36,8	1.45
8-12S	19,0	0.75	3/4-16	1 1/16-12	41,1	1.62	42,2	1.66
10-6S	9,6	0.38	7/8-14	9/16-18	43,2	1.70	31,0	1.22
10-8S	12,7	0.50	7/8-14	3/4-16	43,2	1.70	33,8	1.33
10-10S	16,0	0.63	7/8-14	7/8-14	43,2	1.70	36,8	1.45
10-12S	19,0	0.75	7/8-14	1 1/16-12	45,2	1.78	42,2	1.66
12-8S	12,7	0.50	1 1/16-12	3/4-16	49,3	1.94	36,1	1.42
12-10S	16,0	0.63	1 1/16-12	7/8-14	49,3	1.94	39,1	1.54
12-12S	19,0	0.75	1 1/16-12	1 1/16-12	49,3	1.94	42,2	1.66
12-16S	25,4	1.00	1 1/16-12	1 5/16-12	52,1	2.05	46,0	1.81
12-20S	31,7	1.25	1 1/16-12	1 5/8-12	57,2	2.25	52,3	2.06
14-16S	25,4	1.00	1 3/16-12	1 5/16-12	52,1	2.05	46,0	1.81
16-8S	12,7	0.50	1 5/16-12	3/4-16	52,1	2.05	38,6	1.52
16-10S	16,0	0.63	1 5/16-12	7/8-14	52,1	2.05	41,7	1.64
16-12S	19,0	0.75	1 5/16-12	1 1/16-12	52,1	2.05	44,7	1.76
16-16S	25,4	1.00	1 5/16-12	1 5/16-12	52,1	2.05	46,0	1.81
16-20S	31,7	1.25	1 5/16-12	1 5/8-12	57,2	2.25	52,3	2.06
20-16S	25,4	1.00	1 5/8-12	1 5/16-12	57,2	2.25	51,1	2.01
20-20S	31,7	1.25	1 5/8-12	1 5/8-12	57,2	2.25	52,3	2.06
20-24S	38,1	1.50	1 5/8-12	1 7/8-12	60,7	2.39	59,2	2.33
24-20S	31,7	1.25	1 7/8-12	1 5/8-12	60,7	2.39	55,9	2.20
24-24S	38,1	1.50	1 7/8-12	1 7/8-12	60,7	2.39	59,2	2.33

Steel adapters

SAE O-Ring boss to SAE 37° flare

SAE O-Ring boss to SAE 37° flare

SAE O-Ring boss (adj.)/SAE 37° flare

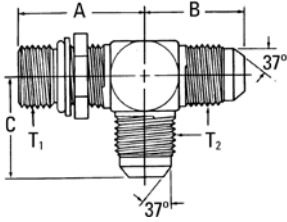

203005-(Dash size) (Ref. SAE 070428)
(Formerly Weatherhead series C5716x)

Dash size	Tube O.D.		Thread T1	Thread T2	A		B		C	
	mm	in			mm	in	mm	in	mm	in
4-4S	6,3	0.25	7/16-20	7/16-20	26,2	1.03	22,6	0.89	22,6	0.89
5-5S	7,9	0.31	1/2-20	1/2-20	28,7	1.13	24,1	0.95	24,1	0.95
6-4-4S	6,3	0.25	9/16-18	7/16-20	31,8	1.25	26,7	1.05	26,7	1.05
6-6S	9,6	0.38	9/16-18	9/16-18	31,8	1.25	26,9	1.06	26,9	1.06
8-8S	12,7	0.50	3/4-16	3/4-16	36,8	1.45	31,8	1.25	31,8	1.25
10-10S	16,0	0.63	7/8-14	7/8-14	43,2	1.70	36,8	1.45	36,8	1.45
12-12S	19,0	0.75	1 1/16-12	1 1/16-12	49,3	1.94	42,2	1.66	42,2	1.66
12-16-16S	25,4	1.00	1 1/16-12	1 5/16-12	52,1	2.05	46,0	1.81	46,0	1.81
16-16S	25,4	1.00	1 5/16-12	1 5/16-12	52,1	2.05	46,0	1.81	46,0	1.81
20-20S	31,7	1.25	1 5/8-12	1 5/8-12	57,2	2.25	52,3	2.06	52,3	2.06

SAE O-Ring boss (adj.)/SAE 37° flare

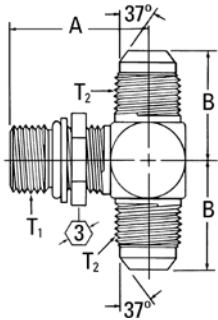

203003-(Dash size) (Ref. SAE 070429)
(Formerly Weatherhead series C5715x)

Dash size	Tube O.D.		Thread T1	Thread T2	A		B	
	mm	in			mm	in	mm	in
4-4S	6,3	0.25	7/16-20	7/16-20	26,2	1.03	22,6	0.89
6-6S	9,6	0.38	9/16-18	9/16-18	31,8	1.25	26,9	1.06
8-8S	12,7	0.50	3/4-16	3/4-16	36,8	1.45	31,8	1.25
10-10S	16,0	0.63	7/8-14	7/8-14	43,2	1.70	36,8	1.45
10-12-12S	19,0	0.95	7/8-14	1 1/16-12	45,2	1.78	42,2	1.66
12-12S	19,0	0.75	1 1/16-12	1 1/16-12	49,3	1.94	42,2	1.66
12-16-16S	25,4	1.00	1 1/16-12	1 5/16-12	52,1	2.05	46,0	1.81
16-16S	25,4	1.00	1 5/16-12	1 5/16-12	52,1	2.05	46,0	1.81
20-20S	31,7	1.25	1 5/8-12	1 5/8-12	57,2	2.25	52,3	2.06

Split flanges

Split flanges

Eaton has standard pressure series (code 61) and high pressure series (code 62) split flange components in kit form that save time in selecting and ordering. Each kit includes two flange halves, four grade-8 hex bolts, four lock washers and an O-Ring. The standard kit has a Buna-N 90 durometer O-Ring that is compatible with petroleum and water-base hydraulic fluids. Optional kits contain EPDM and Viton* O-Ring for applications where fluid compatibility or high temperatures require other than Buna-N O-Ring.

*Viton is a trademark of The Chemours Company FC, LLC.



Two methods can be used to determine the flange dash size and code. The first is by measuring the flange head diameter on the fitting itself. This is referred to as the "K" dimension. The second is by measuring the "A" dimension on the flange or the flange port. Either will determine the dash size and the code since these dimensions are exclusive to either code 61 or code 62 split flange kits. See chart below for these dimensions.

In some cases, split flange fittings are available for hoses which exceed the pressures listed; when ordering fittings or hose assemblies, the terminal end performance rating may reduce the overall rating of the assembly.

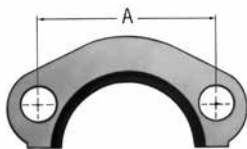

"A" Dim.	"K" Flange head diameter	Flange dash size	Maximum operating pressure*		Recommended bolt torque
			in	psi	
in	in	mm	bar	psi	lb-in
Code 61					
1.50	1.19	-08	350,0	5000	175-225
1.88	1.50	-12	350,0	5000	225-350
2.06	1.75	-16	350,0	5000	325-425
2.31	2.00	-20	280,0	4000	425-550
2.75	2.38	-24	210,0	3000	550-700
3.06	2.81	-32	210,0	3000	650-800
3.50	3.31	-40	175,0	2500	950-1100
4.19	4.00	-48	140,0	2000	1650-1800
Code 62					
1.59	1.25	-08	420,0	6000	175-225
2.00	1.63	-12	420,0	6000	300-400
2.25	1.88	-16	420,0	6000	500-600
2.62	2.12	-20	420,0	6000	750-900
3.12	2.50	-24	420,0	6000	1400-1600
3.81	3.12	-32	420,0	6000	2400-2600

*Per SAE J518 standard.

Assembly procedure

Many leakage problems can be avoided if the split flanges are properly assembled.

To properly assemble

1. Clean all mating surfaces.
2. Lubricate the O-Ring.
3. Partially tighten each bolt in rotation until all are fully tightened to the recommended torque value.

How to order

1. Determine the dash size and the code.
2. Select O-Ring for fluid compatibility.
3. Order by kit number shown on page 110.

Steel adapters

Split flanges, O-Ring and kits

Split flange kits

SAE standard pressure series (Code 61) SAE J518

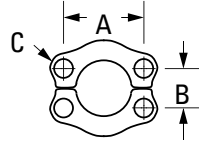
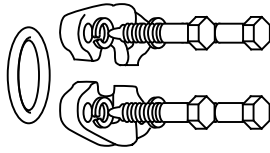

O-Rings material:
Buna-N 90 Durometer
Temperature range:
-40°F to +250°F
(-40°C to + 121°C)

Nominal flange size	Complete kit	*Flange halves 2 required	*Buna-N O-Ring 1 required	*Bolts 4 required	*Lock washer 4 required	A	B	C	Bolt torque lb.-in
1/2	FF593-08	449-74446-8	FF9446-210	FF9442-0520-94	210104-5S	1.50	0.68	0.34	175-225
3/4	FF593-12	449-74446-12	FF9446-214	FF9442-0620-94	210104-6S	1.88	0.88	0.41	250-350
1	FF593-16	449-74446-16	FF9446-219	FF9442-0620-94	210104-2-6S	2.06	1.04	0.41	325-425
1-1/4	FF593-20	449-74446-20	FF9446-222	FF9442-0724-94	210104-7S	2.31	1.18	0.48	425-550
1-1/2	FF593-24	449-74446-24	FF9446-225	FF9442-0824-94	210104-8S	2.75	1.40	0.53	550-700
2	FF593-32	449-74446-32	FF9446-228	FF9442-0824-94	210104-8S	3.06	1.68	0.53	650-800
2-1/2	FF593-40	449-74446-40	FF9446-232	FF9442-0828-94	210104-8S	3.50	2.00	0.53	950-1100
3	FF593-48	449-74446-48	FF9446-237	FF9442-1028-94	210104-10S	4.19	2.44	0.66	1650-1800

* Included in kit.

*Viton kit available as part number FF687-Size. EPDM kit available as part number FF688-size. See page 111 for Viton and EPDM O-Ring part numbers.

Note: All measurements in inches.

SAE high pressure series (Code 62) SAE J518

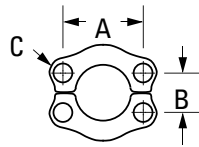
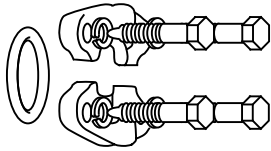

O-Ring material:
Buna-N 90 Durometer
Temperature range:
-40°F to +250°F
(-40°C to + 121°C)

Note: Code 62 split flange kits cannot be used with Cat flange fittings. Use existing split flanges.

Nominal flange size	Complete kit	*Flange halves 2 required	*Buna-N O-Ring 1 required	*Bolts 4 required	*Lock washer 4 required	A	B	C	Bolt torque lb.-in
3/4	FF595-12	FC3425-12-449	FF9446-214	FF9442-0624-94	210104-6S	2.00	0.94	0.42	300-400
1	FF595-16	FC3425-16-449	FF9446-219	FF9442-0728-94	210104-7S	2.25	1.10	0.50	500-600
1-1/4	FF595-20	FC3425-20-449	FF9446-222	FF9442-0828-94	210104-8S	2.62	1.24	0.60	750-900
1-1/2	FF595-24	FC3425-24-449	FF9446-225	FF9442-1036-94	210104-10S	3.12	1.44	0.66	1400-1600
2	FF595-32	FC3425-32-449	FF9446-228	FF9442-1244-94	210104-12S	3.81	1.76	0.78	2400-2600

* Included in kit.

* Viton kit available as part number FF689-size. See page 111 for Viton O-Ring part numbers.

Note: All measurements in inches.

Viton is a trademark of The Chemours Company FC, LLC.

Split flange kits

4 hole flange SAE standard pressure series (Code 61) SAE J518

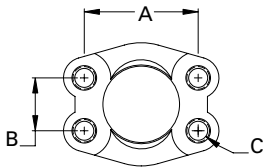

Nominal flange size	4 bolt flange	A	B	C (Threaded)
3/4	FC2119-12-449	1.88	0.88	3/8-16
1	FC2119-16-449	2.06	1.03	7/16-14
1-1/4	FC2119-20-449	2.31	1.19	3/8-16
1-1/2	FC2119-24-449	2.75	1.41	1/2-13
2	FC2119-32-449	3.06	1.69	1/2-13
2-1/2	FC2119-40-449	3.50	2.00	1/2-13

*Available without threads as part number FC3459-size-449.

Note: All measurements in inches.

O-Ring for SAE J518 Split flange

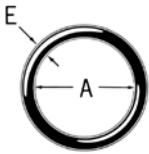

O-Ring base number	Material	Operating temperature range
FF9016 EPDM	80 Durometer	-65°F to +300°F (-55°C to +150°C)
FF9446 Buna-N	90 Durometer Buna-N	-40°F to +250°F (-40°C to +121°C)
22046 Viton	90 Durometer	-15°F to +400°F (-25°C to +205°C)

Viton is a trademark of The Chemours Company FC, LLC.

O-Ring dash size designation	Flange dash size	Nominal flange size	A		E	
			mm	in	mm	in
-210	08	1/2	18,5	0.734	3,5	0.139
-214	12	3/4	24,9	0.984	3,5	0.139
-219	16	1	32,9	1.296	3,5	0.139
-222	20	1 1/4	37,7	1.484	3,5	0.139
-225	24	1 1/2	47,2	1.859	3,5	0.139
-228	32	2	56,7	2.234	3,5	0.139
-232	40	2 1/2	69,4	2.734	3,5	0.139
-237	48	3	85,3	3.359	3,5	0.139

Steel adapters

Split flanges, O-Ring and kits

O-Rings and kits

O-Ring seal kit FF16087-01

Includes: metal box,
O-Rings for ORS -4 through -24,
O-Ring boss -04 through -32,
Split flange -08 through -32,
24 packages with twelve
90 durometer nitrile
O-Ring per package.
Replacement O-Ring can be
ordered individually by
part number listed.



FF16087-01

Connection	Size	Individual O-Ring part no.
ORS	-04	FF9446-11
ORS	-06	FF9446-12
ORS	-08	FF9446-14
ORS	-10	FF9446-16
ORS	-12	FF9446-18
ORS	-16	FF9446-21
ORS	-20	FF9446-25
ORS	-24	FF9446-29
O-Ring Boss	-04	22617-4
O-Ring Boss	-05	22617-5
O-Ring Boss	-06	22617-6
O-Ring Boss	-08	22617-8
O-Ring Boss	-10	22617-10
O-Ring Boss	-12	22617-12
O-Ring Boss	-16	22617-16
O-Ring Boss	-20	22617-20
O-Ring Boss	-24	22617-24
O-Ring Boss	-32	22617-32
Split Flange	-08	FF9446-210
Split Flange	-12	FF9446-214
Split Flange	-16	FF9446-219
Split Flange	-20	FF9446-222
Split Flange	-24	FF9446-225
Split Flange	-32	FF9446-228

BSPB bonded seal for DIN 3852-2 ports

FF9895

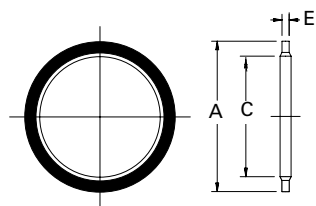

Bonded seal part number	BSPB thread size	A Ref	C Ref	E Ref
		inch	inch	inch
FF9895-02	1/8-28	0.625	0.403	0.080
FF9895-04	1/4-19	0.810	0.536	0.080
FF9895-06	3/8-19	0.937	0.675	0.080
FF9895-08	1/2-14	1.125	0.843	0.097
FF9895-10	5/8-14	1.250	0.920	0.097
FF9895-12	3/4-14	1.375	1.060	0.097
FF9895-16	1-11	1.685	1.329	0.133
FF9895-20	1 1/4-11	2.062	1.685	0.133
FF9895-24	1 1/2-11	2.307	1.902	0.133
FF9895-32	2-11	2.875	2.380	0.133

Material: Steel with bonded Nitrile (Buna-N) seal.

Designating separate SAE O-Ring boss

To order Eaton O-Ring separately without fittings specify the size and material by using the O-Ring base number and dash size. The charts offer a simple method to assure the correct O-Ring for your application.

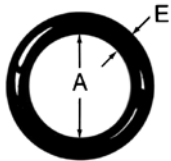

O-Ring base no.	Material	Operating temperature range
22617 (Standard)	Buna-N Nitrile rubber 90 Durometer	-30°F to +250°F (-34°C to +121°C)
22033	EPDM Ethylene propylene diene monomer	-65°F to +212°F (-55°C to +100°C)
22068	Viton Fluoroelastomer 90 Durometer	-15°F to +400°F (-25°C to +205°C)
22012	Buna-N, Low temperature nitrile rubber 90 Durometer	-65°F to +225°F (-55°C to +107°C)

O-Ring dash size	Tube size	A		E	
		mm	in	mm	in
-4	-04 (1/4)	8,9	0.351	1,8	0.072
-6	-06 (3/8)	11,9	0.468	2,0	0.078
-8	-08 (1/2)	16,3	0.644	2,3	0.087
-10	-10 (5/8)	19,3	0.755	2,5	0.097
-12	-12 (3/4)	23,4	0.924	3,0	0.116
-16	-16 (1)	29,7	1.171	3,0	0.116
-20	-20 (1 1/4)	37,6	1.475	3,0	0.118
-24	-24 (1 1/2)	43,7	1.720	3,0	0.118

Designating separate ORS O-Ring

To order Eaton O-Ring separately without fittings specify the size and material by using the O-Ring designator and O-Ring base number. The charts to the right offer a simple method to assure the correct O-Ring for your application.

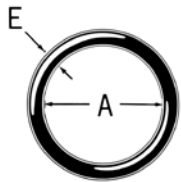

O-Ring base no.	Material	Operating temperature range
FF9446 (Standard)	Buna-N Nitrile Rubber 90 Durometer	-40°F to +250°F (-40°C to +121°C)
FF9807	EPDM Ethylene propylene diene monomer	-65°F to +300°F (-55°C to +150°C)
22046	Viton Fluoroelastomer 90 Durometer	-15°F to +400°F (-25°C to +205°C)
FF9855	Buna-N, Low Temperature Nitrile Rubber 90 Durometer	-65°F to +225°F (-55°C to +107°C)
22546	Neoprene 90 Durometer	-65°F to +300°F (-55°C to +150°C)

O-Ring dash size	Tube size	A		E	
		mm	in	mm	in
-11	-04	7,6	0.301	1,8	0.07
-12	-06	9,2	0.364	1,8	0.07
-14	-08	12,4	0.489	1,8	0.07
-16	-10	15,6	0.614	1,8	0.07
-18	-12	18,8	0.739	1,8	0.07
-21	-16	23,5	0.926	1,8	0.07
-25	-20	29,9	1.176	1,8	0.07
-29	-24	37,8	1.489	1,8	0.07

Viton is a trademark of The Chemours Company FC, LLC.

Steel adapters

SAE split flange to ORS

SAE split flange to ORS

ORS/split flange (Code 62)

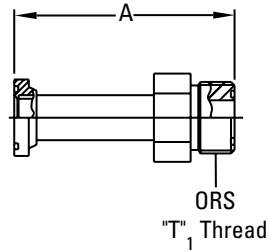

FF5943T(Dash size)

Dash size	Tube O.D.		Thread T1	A	
	mm	in		mm	in
1212S	19,0	0.75	1 3/16-12	77,7	3.06
1616S	25,4	1.00	1 7/16-12	90,7	3.57

45° ORS/split flange (Code 61)

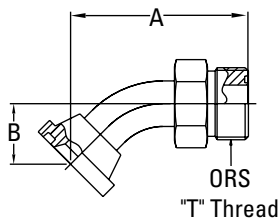

FF6001T(Dash size)

Dash size	Tube O.D.		Thread T	A		B	
	mm	in		mm	in	mm	in
1216S	19,0	0.75	1 3/16-12	74,7	2.94	25,4	1.00

45° ORS/split flange (Code 62)

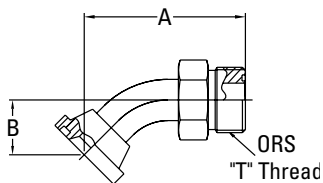

FF6002T(Dash size)

Dash size	Tube O.D.		Thread T	A		B	
	mm	in		mm	in	mm	in
1212S	19,0	0.75	1 3/16-12	74,7	2.94	25,4	1.00
1616S	25,4	1.00	1 7/16-12	86,6	3.41	26,9	1.06

SAE split flange to ORS

90° ORS/split flange (Code 61)

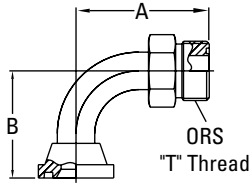

FF5946T(Dash size)

Dash size	Tube O.D.		Thread T	A		B	
	mm	in		mm	in	mm	in
1212S	19,0	0.75	1 3/16-12	67,3	2.65	54,1	2.13
1216S	19,0	0.75	1 3/16-12	67,3	2.65	54,1	2.13
1616S	25,4	1.00	1 7/16-12	81,8	3.22	60,2	2.37
2020S	31,7	1.25	1 11/16-12	88,1	3.47	66,5	2.62
2424S	38,1	1.50	2-12	100,8	3.97	79,2	3.12

90° ORS/split flange (Code 62)

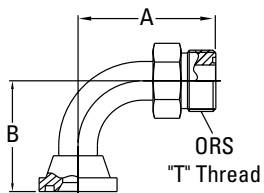

FF5945T(Dash size)

Dash size	Tube O.D.		Thread T	A		B	
	mm	in		mm	in	mm	in
1212S	19,0	0.75	1 3/16-12	67,3	2.65	54,1	2.13
1612S	25,4	1.00	1 7/16-12	67,3	2.65	54,1	2.13
1616S	25,4	1.00	1 7/16-12	81,8	3.22	60,2	2.37
1620S	25,4	1.00	1 7/16-12	88,1	3.47	66,5	2.62
2020S	31,7	1.25	1 11/16-12	88,1	3.47	66,5	2.62
2424S	38,1	1.50	2-12	100,8	3.97	79,2	3.12

90° ORS/split flange (Code 62)

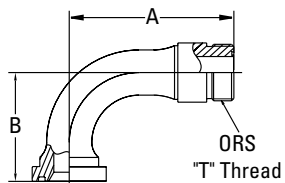

FF6062T(Dash size)

Dash size	Tube O.D.		Thread T	A		B	
	mm	in		mm	in	mm	in
1616S	25,4	1.00	1 7/16-12	105,9	4.17	70,1	2.76

ORS/split flange (Code 62)

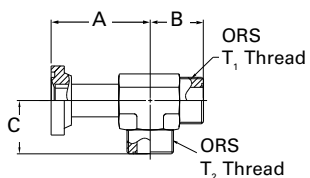

FF2522T(Dash size)

Dash size	Tube O.D.		Thread T1	Thread T2	A		B		C	
	mm	in			mm	in	mm	in	mm	in
1624S	38,1	1.50	1 7/16-12	1 7/16-12	77,8	3.06	41,7	1.64	41,7	1.64

Steel adapters

SAE split flange to SAE 37° flare

SAE split flange to SAE 37° flare

Split flange/SAE 37° flare
Standard pressure series (Code 61)

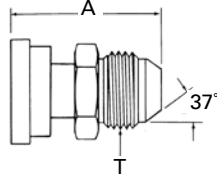

500025-(Dash size) (mates with 449-74446 flanges)
(Formerly Weatherhead 500 series)

The performance rating of these adapters is the lower of the two terminal ends. These adapters are rated to JIC pressures as specified in SAE J514.

Dash size	Split flange size	Tube O.D.		Thread T	A	
		mm	in		mm	in
8S	1/2	12,7	0.50	3/4-16	42,2	1.66
12S	3/4	19,0	0.75	1 1/16-12	48,5	1.91
12-8S	3/4	12,7	0.50	3/4-16	51,6	2.03
16S	1	25,4	1.00	1 5/16-12	51,1	2.01
16-10S	1	16,0	0.63	7/8-14	47,2	1.86
16-12S	1	19,0	0.75	1 1/16-12	58,4	2.30
20S	1 1/4	31,7	1.25	1 5/8-12	62,5	2.46
20-16S	1 1/4	25,4	1.00	1 5/16-12	59,7	2.35
20-24S	1 1/4	38,1	1.50	1 7/8-12	67,0	2.64
24S	1 1/2	38,1	1.50	1 7/8-12	68,8	2.71
24-16S	1 1/2	25,4	1.00	1 5/16-12	61,2	2.41
24-20S	1 1/2	31,7	1.25	1 5/8-12	62,5	2.46
32-16S	2	25,4	1.00	1 5/16-12	58,9	2.32
32-20S	2	31,7	1.25	1 5/8-12	64,0	2.52
32-24S	2	38,1	1.50	1 7/8-12	68,8	2.71
40-24S	2 1/2	38,1	1.50	1 7/8-12	70,4	2.77

Split flange/SAE 37° flare
Standard pressure series (Code 61) -
Long adapter

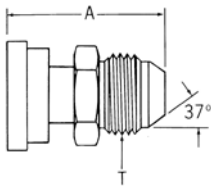

FF5239-(Dash size) (mates with 449-74446 flanges)
(Formerly Weatherhead 500 series)

The performance rating of these adapters is the lower of the two terminal ends. These adapters are rated to JIC pressures as specified in SAE J514.

Dash size	Split flange size	Tube O.D.		Thread T	A	
		mm	in		mm	in
3232S	2	50,8	2.00	2 1/2-12	143,0	5.63

Split flange/SAE 37° flare
Standard pressure series (Code 62)

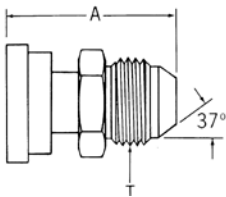

FF5541-(Dash size) (mates with FC3425- size-449 flanges)
(Formerly Weatherhead 600 series)

The performance rating of these adapters is the lower of the two terminal ends. These adapters are rated to JIC pressures as specified in SAE J514.

Dash size	Split flange size	Tube O.D.		Thread T	A	
		mm	in		mm	in
1212S	3/4	19,0	0.75	1 1/16-12	80,5	3.17
1616S	1	25,4	1.00	1 5/16-12	95,5	3.76
2016S	1 1/4	25,4	1.00	1 5/16-12	95,5	3.76
2020S	1 1/4	31,7	1.25	1 5/8-12	97,5	3.84
2416S	1 1/2	25,4	1.00	1 5/16-12	95,5	3.76
2420S	1 1/2	31,7	1.25	1 5/8-12	97,5	3.84
2424S	1 1/2	38,1	1.50	1 7/8-12	118,6	4.67

SAE split flange to SAE 37° flare

Split flange/SAE 37° flare Standard pressure series (Code 62) - Long adapter

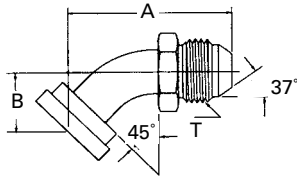

FF5539-(Dash size) (mates with FC3425-size-449 flanges)
(Formerly Weatherhead 645 series)

The performance rating of these adapters is the lower of the two terminal ends.
These adapters are rated to JIC pressures as specified in SAE J514.

Dash size	Split flange size	Tube O.D.		Thread T	A		B	
		mm	in		mm	in	mm	in
12-12S	3/4	19,0	0.75	1 1/16-12	79,8	3.14	25,9	1.02
1612S	1	19,0	0.75	1 1/16-12	78,5	3.09	25,4	1.00
1616S	1	25,4	1.00	1 5/16-12	91,4	3.60	26,9	1.06
2016S	1 1/4	25,4	1.00	1 5/16-12	91,4	3.60	26,9	1.06
2020S	1 1/4	31,7	1.25	1 5/8-12	98,0	3.86	29,2	1.15
2416S	1 1/2	25,4	1.00	1 5/16-12	103,1	4.06	31,8	1.25
2420S	1 1/2	31,7	1.25	1 5/8-12	98,0	3.86	29,2	1.15
2424S	1 1/2	38,1	1.50	1 7/8-12	117,1	4.61	35,8	1.41

Split flange/SAE 37° flare Standard pressure series (Code 61)

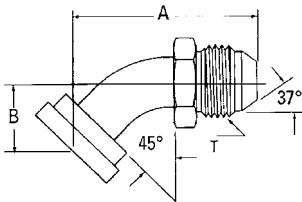

500023-(Dash size) (mates with 449-74446 flanges)
(Formerly Weatherhead 545 series)

The performance rating of these adapters is the lower of the two terminal ends.
These adapters are rated to JIC pressures as specified in SAE J514.

Dash size	Split flange size	Tube O.D.		Thread T	A		B	
		mm	in		mm	in	mm	in
8S	1/2	12,7	0.50	3/4-16	59,4	2.34	25,4	1.00
12S	3/4	19,0	0.75	1 1/16-12	70,3	2.77	25,7	1.01
12-8S	3/4	12,7	0.50	3/4-16	59,4	2.34	25,4	1.00
16S	1	25,4	1.00	1 5/16-12	77,2	3.04	28,7	1.13
16-10S	1	16,0	0.63	7/8-14	65,5	2.58	25,4	1.00
16-12S	1	19,0	0.75	1 1/16-12	70,3	2.77	25,7	1.01
16-20S	1	31,7	1.25	1 5/8-12	82,4	3.25	28,5	1.13
20-12S	1 1/4	19,0	0.75	1 1/16-12	70,3	2.77	25,7	1.01
20-16S	1 1/4	25,4	1.00	1 5/16-12	77,2	3.04	28,7	1.13
24-16S	1 1/2	25,4	1.00	1 5/16-12	78,2	3.08	29,7	1.17
24-20S	1 1/2	31,7	1.25	1 5/8-12	82,3	3.24	28,5	1.12
24-32S	1 1/2	50,8	2.00	2 1/2-12	99,3	3.91	28,5	1.12
40S	2 1/2	63,5	2.50	3-12	131,6	5.18	42,2	1.66
40-24S	2 1/2	38,1	1.50	1 7/8-12	90,9	3.58	29,7	1.17

Split flange/SAE 37° flare Standard pressure series (Code 61) - Long adapter

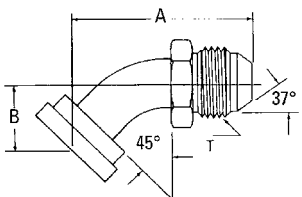

FF5238-(Dash size) (mates with 449-74446 flanges)
(Formerly Weatherhead 545 series)

The performance rating of these adapters is the lower of the two terminal ends.
These adapters are rated to JIC pressures as specified in SAE J514.

Dash size	Split flange size	Tube O.D.		Thread T	A		B	
		mm	in		mm	in	mm	in
1212S	3/4	19,0	0.75	1 1/16-12	78,5	3.09	25,4	1.00
1616S	1	25,4	1.00	1 5/16-12	91,4	3.60	26,9	1.06
1620S	1	31,7	1.25	1 5/8-12	92,6	3.64	26,9	1.06
2020S	1 1/4	31,7	1.25	1 5/8-12	98,0	3.86	29,2	1.15
2420S	1 1/2	31,7	1.25	1 5/8-12	98,0	3.86	35,8	1.41
2424S	1 1/2	38,1	1.50	1 7/8-12	117,1	4.61	35,8	1.41
3232S	2	50,8	2.00	2 1/2-12	153,4	6.04	50,8	2.00

Steel adapters

SAE split flange to SAE 37° flare

SAE split flange to SAE 37° flare

Split flange/SAE 37° flare
Standard pressure series (Code 61)

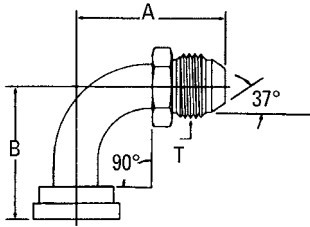

500024-(Dash size) (mates with 449-74446 flanges)
(Formerly Weatherhead 590 series)

The performance rating of these adapters is the lower of the two terminal ends.
These adapters are rated to JIC pressures as specified in SAE J514.

Dash size	Split flange size	Tube O.D.		Thread T	A		B	
		mm	in		mm	in	mm	in
8S	1/2	12,7	0.50	3/4-16	45,2	1.78	41,1	1.62
12-8S	3/4	12,7	0.50	3/4-16	45,2	1.78	41,1	1.62
12-10S	3/4	16,0	0.63	7/8-14	60,4	2.38	54,6	2.15
16-10S	1	16,0	0.63	7/8-14	54,9	2.16	53,9	2.12
16-12S	1	19,0	0.75	1 1/16-12	63,2	2.49	54,6	2.15
20-12S	1 1/4	19,0	0.75	1 1/16-12	63,2	2.49	54,6	2.15
20-24S	1 1/4	38,1	1.50	1 7/8-12	90,9	3.58	68,3	2.69
24-16S	1 1/2	25,4	1.00	1 5/16-12	70,9	2.79	62,0	2.44
24-20S	1 1/2	31,7	1.25	1 5/8-12	79,7	3.14	63,5	2.50
24-32S	1 1/2	50,8	2.00	1 7/8-12	100,4	3.95	69,8	2.75
32-20S	2	31,7	1.25	1 5/8-12	79,7	3.14	65,0	2.56
32-24S	2	38,1	1.50	1 7/8-12	90,9	3.58	69,8	2.75
40-24S	2 1/2	38,1	1.50	1 7/8-12	90,9	3.58	71,4	2.81
40-32S	2 1/2	50,8	2.00	2 1/2-12	113,3	4.46	84,1	3.31
40-40S	2 1/2	63,5	2.50	3-12	148,8	5.86	131,8	5.19

Split flange/SAE 37° flare
Standard pressure series (Code 61)

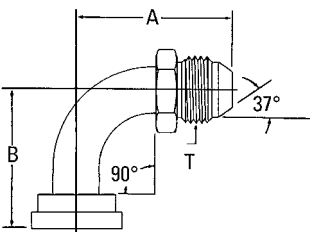

FF5162-(Dash size) (mates with 449-74446 flanges)
(Formerly Weatherhead 590 series)

The performance rating of these adapters is the lower of the two terminal ends.
These adapters are rated to JIC pressures as specified in SAE J514.

Dash size	Split flange size	Tube O.D.		Thread T	A		B	
		mm	in		mm	in	mm	in
0808S	1/2	12,7	0.50	3/4-16	54,9	2.16	41,1	1.62
1212S	3/4	19,0	0.75	1 1/16-12	71,4	2.81	54,1	2.13
1612S	1	19,0	0.75	1 1/16-12	71,4	2.81	54,1	2.13
1616S	1	25,4	1.00	1 5/16-12	86,6	3.41	60,4	2.38
1620S	1	31,7	1.25	1 5/8-12	87,9	3.46	60,4	2.38
2016S	1 1/4	25,4	1.00	1 5/16-12	86,6	3.41	60,4	2.38
2020S	1 1/4	31,7	1.25	1 5/8-12	94,2	3.71	66,5	2.62
2416S	1 1/2	25,4	1.00	1 5/16-12	86,6	3.41	60,4	2.38
2420S	1 1/2	31,7	1.25	1 5/8-12	94,2	3.71	66,5	2.62
2424S	1 1/2	38,1	1.50	1 7/8-12	110,0	4.33	79,2	3.12
3232S	2	50,8	2.00	2 1/2-12	145,0	5.71	114,3	4.50

SAE split flange to SAE 37° flare

Split flange/SAE 37° flare High pressure series (Code 62)

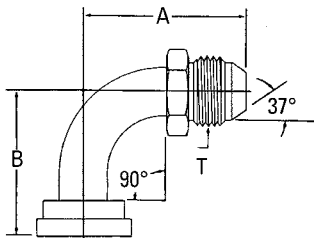

FF5540-(Dash size) (mates with FC3425 - size-449 flanges)

The performance rating of these adapters is the lower of the two terminal ends. These adapters are rated to JIC pressures as specified in SAE J514.

Dash size	Split flange size	Tube O.D.		Thread T	A		B	
		mm	in		mm	in	mm	in
1212S	3/4	19,0	0.75	1 1/16-12	71,4	2.81	54,1	2.13
1612S	1	19,0	0.75	1 1/16-12	71,4	2.81	54,1	2.13
1616S	1	25,4	1.00	1 5/16-12	86,6	3.41	60,4	2.38
2020S	1 1/4	31,7	1.25	1 5/8-12	94,2	3.71	66,5	2.62
2416S	1 1/2	25,4	1.00	1 5/16-12	86,6	3.41	69,8	2.75
2420S	1 1/2	31,7	1.25	1 5/8-12	94,2	3.71	66,5	2.62
2424S	1 1/2	38,1	1.50	1 7/8-12	110,0	4.33	79,2	3.12

SAE swivel flange to SAE split flange

SAE swivel flange/split flange SAE Standard pressure series (Code 61)

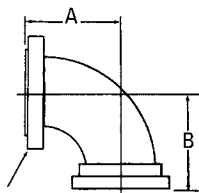

504089-(Dash size)

(suitable for pressures through SAE 100R16 2 wire braid hose)

Dash size	Shoulder size	Flange size	A		B	
			mm	in	mm	in
16S	1	1	52,3	2.06	60,2	2.37
20S	1 1/4	1 1/4	58,7	2.31	63,5	2.50
24S	1 1/2	1 1/2	66,5	2.62	69,8	2.75
32S	2	2	79,2	3.12	82,5	3.25
40S	2 1/2	2 1/2	119,1	4.69	131,8	5.19

SAE swivel flange/split flange SAE Standard pressure series (Code 61)

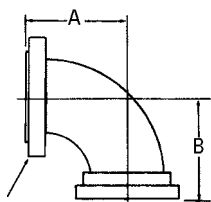

FF5321-(Dash size)

(suitable for pressures through SAE 100R12 4 spiral hose)

Dash size	Shoulder size	Flange size	A		B	
			mm	in	mm	in
1616S	1	1	60,4	2.38	60,4	2.38
2020S	1 1/4	1 1/4	66,5	2.62	66,5	2.62
2424S	1 1/2	1 1/2	79,2	3.12	79,2	3.12
3232S	2	2	114,3	4.50	114,3	4.50

Steel adapters

SAE flareless to SAE 37° union

SAE flareless to SAE 37° union

Male SAE flareless/SAE 37° flare*

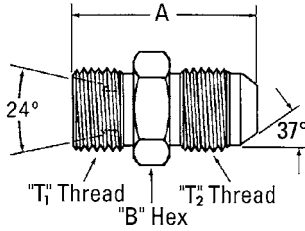

FF1315-(Dash size)

Dash size	Tube O.D.		Thread T1	Thread T2	A		B	
	mm	in			mm	in	mm	in
0404S	6,3	0.25	7/16-20	7/16-20	31,0	1.22	12,7	0.50
0604S	9,6	0.38	9/16-18	7/16-20	32,3	1.27	15,7	0.62
0606S	9,6	0.38	9/16-18	9/16-18	32,5	1.28	15,7	0.62
0806S	12,7	0.50	3/4-16	9/16-18	34,8	1.37	20,6	0.81
0808S	12,7	0.50	3/4-16	3/4-16	37,3	1.47	20,6	0.81
1008S	16,0	0.63	7/8-14	3/4-16	40,4	1.59	23,9	0.94
1010S	16,0	0.63	7/8-14	7/8-14	42,9	1.69	23,9	0.94
1212S	19,0	0.75	1 1/16-12	1 1/16-12	49,0	1.93	28,5	1.12
1616S	25,4	1.00	1 5/16-12	1 5/16-12	50,3	1.98	35,1	1.38

Flareless tube nut*

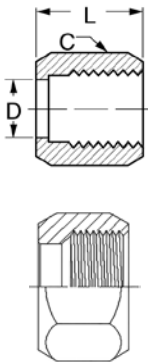

210294-(Dash size)

Use with FF1315-(Dash size) body only
(Ref. SAE 080110)

Dash size	Tube O.D.		Thread T	A		B	
	mm	in		mm	in	mm	in
4S	6,3	0.25	7/16-20	17,8	0.70	14,2	0.56
6S	9,6	0.38	9/16-18	19,0	0.75	17,6	0.69
8S	12,7	0.50	3/4-16	21,3	0.84	22,4	0.88
10S	16,0	0.63	7/8-14	23,4	0.92	25,4	1.00
12S	19,0	0.75	1 1/16-12	24,6	0.97	31,8	1.25
14S	22,3	0.88	1 3/16-12	25,4	1.00	35,1	1.38
16S	25,4	1.00	1 5/16-12	26,7	1.05	38,1	1.50

Ferrule-style A* (for flareless tube fittings)

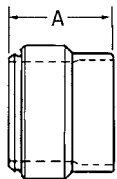

FF9173-(Dash size)

Use with FF1315-(Dash size) body only
(Ref. SAE 080115A)

Dash size	Tube O.D.		A	
	mm	in	mm	in
04S	6,3	0.25	9,1	0.36
06S	9,6	0.38	9,9	0.39
08S	12,7	0.50	10,9	0.43
10S	16,0	0.63	11,2	0.44
12S	19,0	0.75	11,9	0.47
16S	25,4	1.00	12,2	0.48

Note: *All three components (adapter FF1315, tube nut 210294 and ferrule FF9173) required for assembly. Order by Part Number FF1316-(dash size) for complete assembly.

Brace and weld to split flange

Brace/solid flanged head SAE
Standard pressure series (Code 61)

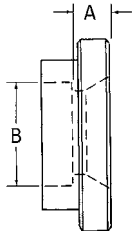

71418-(Dash size)

Dash size	Split flange size	Tube O.D.		A		B	
		mm	in	mm	in	mm	in
12-12S	3/4	19,0	0.75	7,9	0.31	19,0	0.75
16-12S	3/4	25,4	1.00	7,9	0.31	25,4	1.00
16-16S	1	25,4	1.00	7,9	0.31	25,4	1.00
20-20S	1 1/4	31,7	1.25	7,9	0.31	31,8	1.25
24-24S	1 1/2	38,1	1.50	9,7	0.38	38,1	1.50
32-32S	2	50,8	2.00	9,7	0.38	50,8	2.00
40-40S	2 1/2	63,5	2.50	11,2	0.44	63,5	2.50

Brace/(flanged head) SAE
Standard pressures series (Code 61)

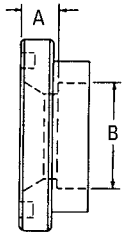

4624-(Dash size)

Dash size	Split flange size	Tube O.D.		A		B	
		mm	in	mm	in	mm	in
12S	3/4	19,0	0.75	7,9	0.31	19,0	0.75
12-16S	3/4	25,4	1.00	7,9	0.31	25,4	1.00
16S	1	25,4	1.00	7,9	0.31	25,4	1.00
16-12S	1	19,0	0.75	7,9	0.31	19,0	0.75
16-20S	1	31,7	1.25	7,9	0.31	31,8	1.25
20S	1 1/4	31,7	1.25	7,9	0.31	31,8	1.25
20-16S	1 1/4	25,4	1.00	7,9	0.31	25,4	1.00
24S	1 1/2	38,1	1.50	9,7	0.38	38,1	1.50
24-16S	1 1/2	25,4	1.00	9,7	0.38	25,4	1.00
24-20S	1 1/2	31,7	1.25	7,9	0.31	31,8	1.25
32S	2	50,8	2.00	9,7	0.38	50,8	2.00
32-16S	2	25,4	1.00	7,1	0.28	25,4	1.00
32-24S	2	38,1	1.50	9,7	0.38	38,1	1.50
40-32S	2 1/2	50,8	2.00	11,2	0.44	50,8	2.00

Steel adapters

Braze and weld to split flange

Braze and weld to split flange

Buttweld (pipe)/solid flanged head SAE Standard pressure series (Code 61)

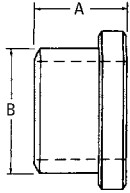

71416-(Dash size)

Dash size	Flange size	A		B	
		mm	in	mm	in
16S	1	27,4	1.08	33,6	1.32
20S	1 1/4	27,4	1.08	42,2	1.66
24S	1 1/2	29,0	1.14	48,3	1.90
32S	2	29,0	1.14	60,4	2.38

Saddle weld (pipe)/solid flanged head SAE Standard pressure series (Code 61)

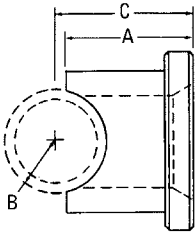

71422-(Dash size)

Dash size	Flange size	A		B		C	
		mm	in	mm	in	mm	in
20-20S	1 1/4	32,3	1.27	21,0	0.83	44,9	1.77

Braze/(flanged head) SAE High pressure series (Code 62)

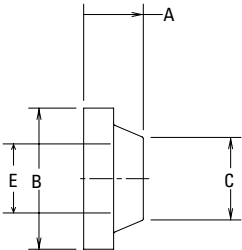

FC1102-(Dash size)

Dash size	Tube O.D.		A		B		C		E	
	mm	in	mm	in	mm	in	mm	in	mm	in
0808S	12,7	0.50	15,7	0.62	31,7	1.25	17,8	0.70	9,9	0.39
1208S	12,7	0.50	15,7	0.62	41,4	1.63	24,1	0.95	9,9	0.39
1212S	19,0	0.75	17,5	0.69	41,4	1.63	24,1	0.95	14,7	0.58
1612S	25,4	1.00	17,5	0.69	47,7	1.88	31,5	1.24	14,7	0.58
1616S	25,4	1.00	15,7	0.62	47,7	1.88	31,5	1.24	20,8	0.82
2012S	31,7	1.25	15,7	0.62	54,1	2.13	38,3	1.51	19,0	0.75
2016S	31,7	1.25	15,7	0.62	54,1	2.13	38,3	1.51	20,8	0.82
2020S	31,7	1.25	15,7	0.62	54,1	2.13	38,1	1.50	26,7	1.05
2416S	38,1	1.50	15,7	0.62	63,5	2.50	46,5	1.83	20,8	0.82
2420S	38,1	1.50	15,7	0.62	63,5	2.50	46,5	1.83	26,7	1.05
2424S	38,1	1.50	19,0	0.75	63,5	2.50	46,5	1.83	32,2	1.27
3224S	50,8	2.00	19,0	0.75	79,5	3.13	63,0	2.48	32,2	1.27
3232S	50,8	2.00	28,4	1.12	79,5	3.13	58,7	2.31	43,7	1.72

Braze/solid flanged head SAE High pressure series (Code 62)

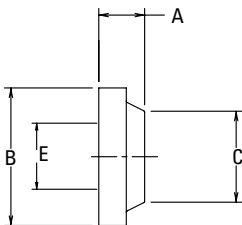

FC1132-(Dash size)

Dash size	Tube O.D.		A		B		C		E	
	mm	in	mm	in	mm	in	mm	in	mm	in
1616	25,4	1.00	15,7	0.62	47,7	1.88	31,5	1.24	20,5	0.81

Braze and weld to SAE 37° flare

Weld port/SAE 37° flare

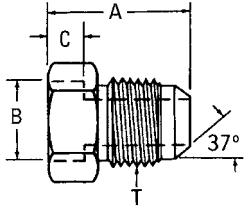

202232-(Dash size)

Dash size	IPS Size		Thread T	A		B		C	
	mm	in		mm	in	mm	in	mm	in
1/4-8S	6,3	0.25	3/4-16	30,5	1.20	14,2	0.56	9,7	0.38
1/2-12S	12,7	0.50	1 1/16-12	39,1	1.54	21,8	0.86	12,7	0.50
1-20S	25,4	1.00	1 5/8-12	46,0	1.81	34,0	1.34	16,0	0.63

Braze port/SAE 37° flare

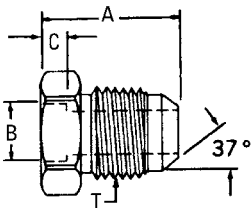

73014-(Dash size)

Dash size	Tube O.D.		Thread T	A		B		C	
	mm	in		mm	in	mm	in	mm	in
4S	6,3	0.25	7/16-20	18,8	0.74	6,4	0.25	4,0	0.16
5S	7,9	0.31	1/2-20	20,3	0.80	7,9	0.31	4,0	0.16
6S	9,6	0.38	9/16-18	20,6	0.81	9,7	0.38	4,0	0.16
8S	12,7	0.50	3/4-16	23,9	0.94	12,7	0.50	4,0	0.16
8-6S	12,7	0.50	9/16-18	21,3	0.84	12,7	0.50	4,0	0.16
10S	15,7	0.62	7/8-14	27,2	1.07	15,7	0.62	4,0	0.16
12S	19,0	0.75	1 1/16-12	31,5	1.24	19,0	0.75	6,4	0.25
12-10S	19,0	0.75	7/8-14	28,7	1.13	19,0	0.75	6,4	0.25
16S	25,4	1.00	1 5/16-12	32,8	1.29	25,4	1.00	6,4	0.25
16-12S	25,4	1.00	1 1/16-12	31,5	1.24	25,4	1.00	6,4	0.25
16-20S	31,7	1.25	1 5/8-12	35,6	1.40	25,4	1.00	6,4	0.25
20S	31,7	1.25	1 5/8-12	35,6	1.40	31,8	1.25	6,4	0.25
20-16S	31,7	1.25	1 5/16-12	32,8	1.29	31,8	1.25	6,4	0.25
24S	38,1	1.50	1 7/8-12	40,1	1.58	38,1	1.50	6,4	0.25
24-20S	38,1	1.50	1 5/8-12	37,1	1.46	38,1	1.50	6,4	0.25
24-32S	38,1	1.50	2 1/2-12	49,5	1.95	38,1	1.50	6,4	0.25
32S	50,8	2.00	2 1/2-12	49,8	1.96	50,8	2.00	6,4	0.25
40S	63,5	2.50	3-12	47,2	1.86	63,5	2.50	6,4	0.25

Steel adapters

Application data

Versil-Flare™ flareless and Versil-Flare SAE 37° flared type

Both styles use the same SAE 37° flared body

Before connection

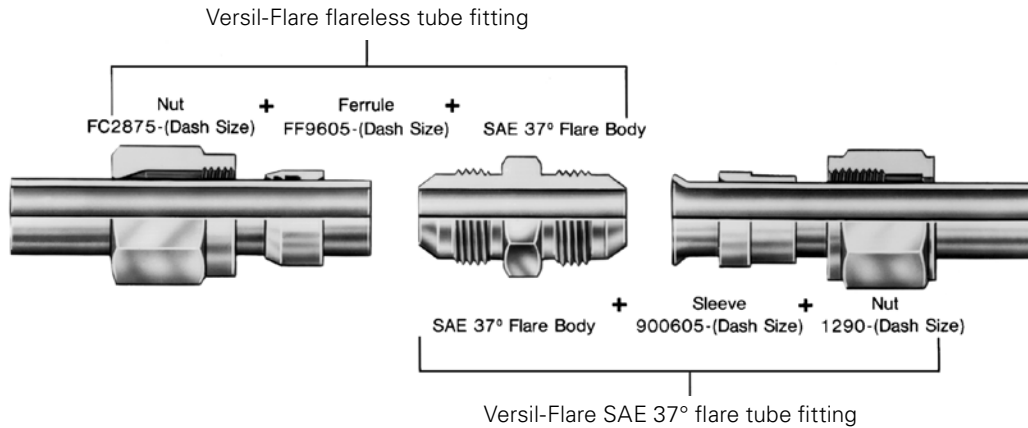

After connection

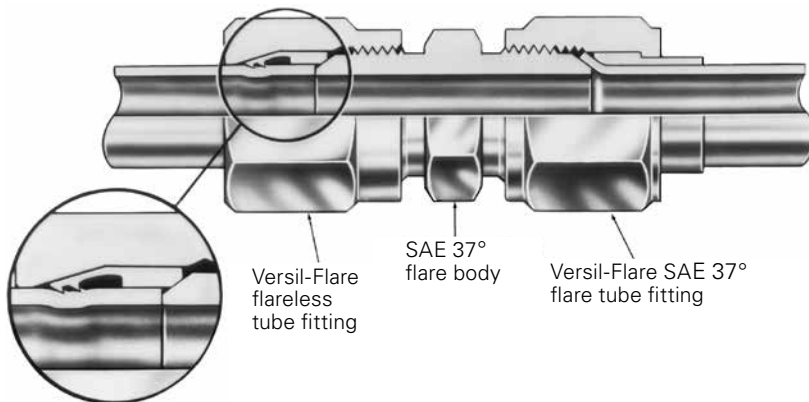

One inventory of bodies (any standard SAE 37° flare fitting) allows both flareless and flared type connection of standard steel hydraulic tubing. It is no longer necessary to inventory flared tube fittings plus the special bodies, nuts and sleeves for flareless tube fittings. The Eaton total tube fitting concept reduces inventory expense.

Versil-Flare™ flareless tube fitting

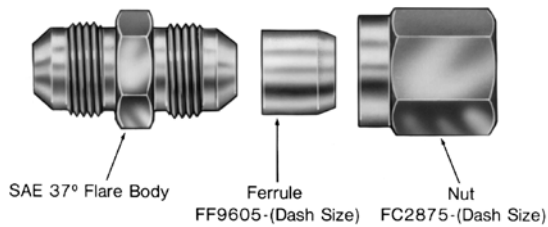

The Eaton Versil-Flare flareless tube fitting can use any standard SAE 37° male flare adapter or hose fitting as a body. This eliminates the need to inventory special flareless tube fitting bodies and results in reduced inventory expense. Eaton Versil-Flare flareless tube fittings are available in size from 3/16" tube O.D. to 2" tube O.D.

Presetting tools and extra assembly time are eliminated because there's no need for flaring, special preparation or presetting with the Eaton Versil-Flare flareless tube fitting. The chance of assembly error is reduced because the ferrule can be installed only one way and assembly is the same for all sizes and tube wall thicknesses. This assures a tight joint every time. These features improve production rates.

Versil-Flare™ flared tube fitting

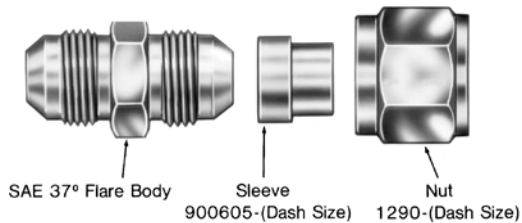

The Eaton industrial standard three piece Versil-Flare flared type tube fitting can be used on the full range of standard steel hydraulic tubing in various wall thicknesses from 3/16" tube O.D. to 2" tube O.D. All three components are constructed from high quality zinc plated steel for long service life.

The standard SAE 37° flare angle is used to produce a highly efficient seal under hydraulic pressures. The sleeve is used to help support the tube and absorb vibration.

Assembly is easy. A properly sized wrench and flaring tool are all that is necessary. This is important in tight locations. Eaton standard SAE 37° flare type fittings can also be dis-assembled and reassembled repeatedly.

Eaton quality is built into every component to assure leakproof connections. The Eaton standard SAE 37° flare type tube fitting conforms to the following hydraulic tube fitting standards. Society of Automotive Engineers, SAE J514.

Selection and sizing for both Eaton Versil-Flare flareless and Versil-Flare flared tube fittings

Tubing selection and sizing

Both Eaton Versil-Flare flareless and flared tube fittings can be used with SAE J-525 electric resistance welded, cold worked annealed, SAE J-524 seamless annealed tubing and SAE J527 brazed double wall low carbon steel tubing. SAE J356 welded flash controlled normalized steel tubing can only be used with Eaton Versil-Flare flareless tube fittings. **The maximum hardness of the above tubing should not exceed Rockwell B65.** Selection of proper tubing material, size and wall thickness depends on corrosion conditions, pressure and flow requirements and other operating requirements of the system.

Steel adapters

Versil-Flare™ - flareless and flared

Versil-Flare - flareless and flared

Versil-Flare flareless tube nut

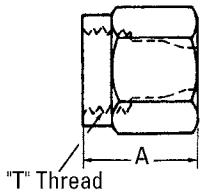

FC2875-(Dash size)

Use with FF9605-(Dash size) ferrule only

Dash size	Tube O.D.		Thread T	A	
	mm	in		mm	in
03S	4,8	0.19	3/8-24	20,1	0.79
04S	6,3	0.25	7/16-20	20,8	0.82
05S	7,9	0.31	1/2-20	20,8	0.82
06S	9,6	0.38	9/16-18	21,8	0.86
08S	12,7	0.50	3/4-16	27,4	1.08
10S	16,0	0.63	7/8-14	28,5	1.12
12S	19,0	0.75	1 1/16-12	34,5	1.36
16S	25,4	1.00	1 5/16-12	35,6	1.40
20S	31,7	1.25	1 5/8-12	45,7	1.80
24S	38,1	1.50	1 7/8-12	46,7	1.84

Versil-Flare flareless tube ferrule

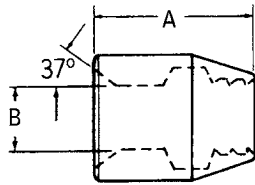

FF9605-(Dash size)

Use with FC2875-(Dash size) nut only

Dash size	Tube O.D.		A		B	
	mm	in	mm	in	mm	in
03S	4,8	0.19	10,2	0.40	4,8	0.19
04S	6,3	0.25	10,7	0.42	6,4	0.25
05S	7,9	0.31	10,7	0.42	7,9	0.31
06S	9,6	0.38	11,7	0.46	9,7	0.38
08S	12,7	0.50	14,5	0.57	12,7	0.50
10S	16,0	0.63	14,7	0.58	15,7	0.62
12S	19,0	0.75	17,8	0.70	19,0	0.75
16S	25,4	1.00	17,8	0.70	25,4	1.00
20S	31,7	1.25	25,4	1.00	31,8	1.25
24S	38,1	1.50	25,4	1.00	38,1	1.50
32S	50,8	2.00	29,7	1.17	50,8	2.00

Versil-Flare SAE 37° Nut

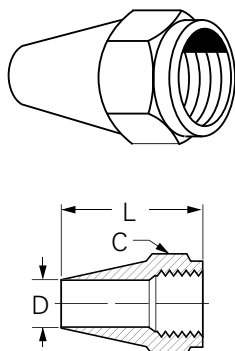

221000-(Dash size) (Ref. SAE 070111)

(Formerly Weatherhead series C5115x)

Dash size	Tube O.D.		Hex C		D		L
	mm	in	mm	in	mm	in	
4S	6,3	1/4	14,3	9/16	6,4	.255	25,4 1.00
5S	7,9	5/16	16,0	5/8	7,9	.318	26,9 1.06
6S	9,6	3/8	17,8	11/16	9,7	.380	27,6 1.09
8S	12,7	1/2	22,3	7/8	12,8	.505	32,5 1.28
10S	16,0	5/8	25,4	1	16,0	.631	37,6 1.48
12S	19,0	3/4	31,7	1-1/4	19,2	.756	42,2 1.66
14S	22,2	7/8	34,9	1-3/8	22,4	.881	46,0 1.81
16S	25,4	1	38,1	1-1/2	25,6	1.006	49,3 1.94

Versil-Flare - flareless and flared

Versil-Flare SAE 37° flared style "B" nut

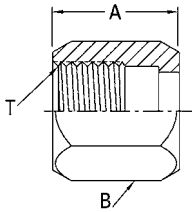

1290-(Dash size) (Ref. SAE 070110)
(Formerly Weatherhead series C5105x)
Use with 900605 tube sleeve only

Dash size	Tube O.D.		Thread T	A		B	
	mm	in		mm	in	mm	in
2S	3,3	0.13	5/16-24	14,0	0.55	9,5	0.38
3S	4,8	0.19	3/8-24	15,2	0.60	11,2	0.44
4S*	6,3	0.25	7/16-20	15,7	0.62	14,2	0.56
5S	7,9	0.31	1/2-20	17,0	0.67	15,7	0.62
6S*	9,6	0.38	9/16-18	18,3	0.72	17,6	0.69
8S*	12,7	0.50	3/4-16	21,3	0.84	22,4	0.88
10S*	16,0	0.63	7/8-14	24,6	0.97	25,4	1.00
12S*	19,0	0.75	1 1/16-12	25,9	1.02	31,8	1.25
14S	22,3	0.88	1 3/16-12	27,4	1.08	35,1	1.38
16S*	25,4	1.00	1 5/16-12	28,5	1.12	38,1	1.50
20S	31,7	1.25	1 5/8-12	31,0	1.22	50,8	2.00
24S*	38,1	1.50	1 7/8-12	35,8	1.41	57,2	2.25
32S	50,8	2.00	2 1/2-12	40,4	1.59	73,1	2.88

* Also available in stainless steel as 259-1290-(dash size).
(Formerly Weatherhead part number 5117x)

Versil-Flare SAE 37° flared sleeve

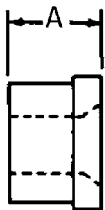
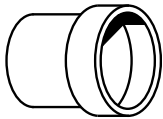

900605-(Dash size) (Ref. SAE 070115)
(Formerly Weatherhead series C5165x)
Use with 1290 short nut only

Dash size	Tube O.D.		A	
	mm	in	mm	in
2S	3,3	0.13	8,6	0.34
3S	4,8	0.19	8,6	0.34
4S	6,3	0.25	10,4	0.41
5S	7,9	0.31	11,2	0.44
6S	9,6	0.38	12,7	0.50
8S	12,7	0.50	14,2	0.56
10S	16,0	0.63	16,8	0.66
12S	19,0	0.75	17,6	0.69
14S	22,3	0.88	19,3	0.76
16S	25,4	1.00	19,8	0.78
20S	31,7	1.25	23,1	0.91
24S	38,1	1.50	28,5	1.12
32S	50,8	2.00	30,3	1.19

* Also available in stainless steel as 259-900605-(dash size).
(Formerly Weatherhead part number 5177x)

Steel adapters

Specials

Specials

External pipe/30° flare

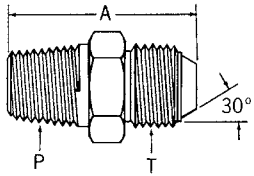

2004-(Dash size)

(Formerly Weatherhead series C92)

Dash size	Tube O.D.		Thread P	Thread T	A	
	mm	in			mm	in
12-16S	25,4	1.00	3/4-14	1 5/16-14	46,7	1.84
16-16S	25,4	1.00	1-11 1/2	1 5/16-14	51,6	2.03
20-20S	31,7	1.25	1 1/4-11 1/2	1 5/8-14	59,4	2.34

42° Inverted flare/SAE 37° flare

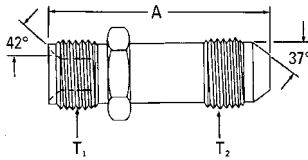

202124-(Dash size) and FF1327-(Dash size) Long*

(Formerly Weatherhead series C5880x)

Dash size	Tube O.D.		Thread T1	Thread T2	A	
	mm	in			mm	in
3-3S	4,8	0.19	3/8-24	3/8-24	27,2	1.07
3-4S	6,3	0.25	3/8-24	7/16-20	29,0	1.14
0304S*	6,3	0.25	3/8-24	7/16-20	61,0	2.40
4-4S	6,3	0.25	7/16-24	7/16-20	29,0	1.14
0404S*	6,3	0.25	7/16-24	7/16-20	61,0	2.40
5-4S	6,3	0.25	1/2-20	7/16-20	29,5	1.16
5-5S	7,9	0.31	1/2-20	1/2-20	29,0	1.14
5-6S	9,6	0.38	1/2-20	9/16-18	30,2	1.19
6-6S	9,6	0.38	5/8-18	9/16-18	31,0	1.22
8-8S	12,7	0.50	3/4-18	3/4-18	37,1	1.46

*Length required to insert adapter at installation.

42° Inverted flare/SAE 37° flare (Brass)

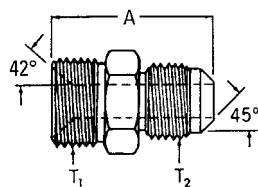

200001-(Dash size)

Dash size	Tube O.D.		Thread T1	Thread T2	A	
	mm	in			mm	in
4-4B	6,3	0.25	7/16-24	7/16-20	27,7	1.09
4-5B	7,9	0.31	7/16-24	1/2-20	28,5	1.12
4-6B	9,6	0.38	7/16-24	5/8-18	30,7	1.21
5-4B	6,3	0.25	1/2-20	7/16-20	27,9	1.10
5-5B	7,9	0.31	1/2-20	1/2-20	29,5	1.16
5-6B	9,6	0.38	1/2-20	5/8-18	31,8	1.25
6-5B	7,9	0.31	5/8-18	1/2-20	31,0	1.22
6-6B	9,6	0.38	5/8-18	5/8-18	32,5	1.28
7-6B	9,6	0.38	11/16-18	5/8-18	36,3	1.43
7-8B	12,7	0.50	11/16-18	3/4-16	39,6	1.56
8-6B	9,6	0.38	3/4-18	5/8-18	36,3	1.43
8-8B	12,7	0.50	3/4-18	3/4-16	39,6	1.56
10-10B	16,0	0.63	7/8-18	7/8-14	44,7	1.76
12-12B	19,0	0.75	1 1/16-16	1 1/16-14	52,0	2.05

WARNING: California Proposition 65, see page 89.

Specials

30° Inverted flare/SAE 37° flare

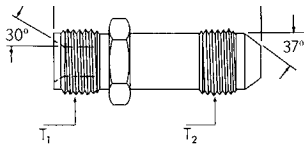

FF1353-(Dash size) and FF1354-(Dash size) long*

Dash size	Tube O.D.		Thread T1	Thread T2	A	
	mm	in			mm	in
0404S	6,3	0.25	7/16-20	7/16-20	33,8	1.33
0404S*	6,3	0.25	7/16-20	7/16-20	63,5	2.50

*Length required to insert adapter at installation.

Restrictor male pipe/female pipe

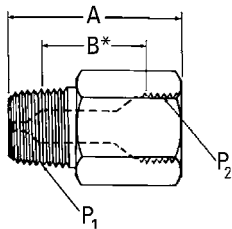

FF1980-(Dash size)†

Dash size	Tube O.D.		Thread P1	Thread P2	A		B*	
	mm	in			mm	in	mm	in
0404	6,3	0.25	1/4-18	1/4-18	35,3	1.39	16,2	0.64
0606	9,6	0.38	3/8-18	3/8-18	36,6	1.44	17,6	0.69
0808	12,7	0.50	1/2-14	1/2-14	47,5	1.87	22,1	0.87

*Length required to insert adapter at installation.

† Ordering Information: Eaton Restrictor Adapters are available in orifice sizes from 0.60 to 0.25 inches.

When ordering restrictor adapters, it is important to indicate the drill size required.

For example: For a 0.125 drill size in FF1980-0404 adapter, order as FF1980-125-0404.

If you indicate the desired orifice size in inches, the appropriate 3 digit number will be assigned.

Restrictor SAE 37° male flare/SAE 37° female

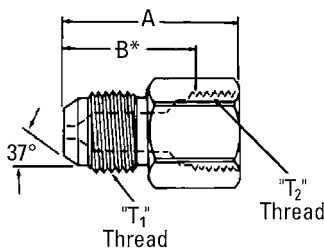

FF1981-(Dash size)†

Dash size	Tube O.D.		Thread T1	Thread T2	A		B*	
	mm	in			mm	in	mm	in
0404	6,3	0.25	7/16-20	7/16-20	28,9	1.14	17,5	0.69
0606	9,6	0.38	9/16-18	9/16-18	30,2	1.19	18,3	0.72
0808	12,7	0.50	3/4-16	3/4-16	34,5	1.36	25,6	1.01

*Length required to insert adapter at installation.

† Ordering Information: Eaton Restrictor Adapters are available in orifice sizes from 0.60 to 0.25 inches.

When ordering restrictor adapters, it is important to indicate the drill size required.

For example: For a 0.125 drill size in FF1980-0404 adapter, order as FF1980-125-0404.

If you indicate the desired orifice size in inches, the appropriate 3 digit number will be assigned.

SAE 37° flare to O-Ring port (steel)

Includes O-ring

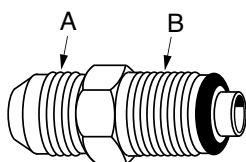

FF4184-(Dash size) (Formerly Weatherhead series 41157x)

Dash size	Tube size	Thread A	Thread B
-0404S	1/4	7/16-20	7/16-24
-0606S	3/8	9/16-18	5/8-18
-0808S	1/2	3/4-16	3/4-16
-1010S	5/8	7/8-14	7/8-14
-1212S	3/4	1 1/16-12	1 1/16-16

Includes O-Ring.

Steel adapters

Metric thread dimensions

Metric thread dimensions

Conversion adapters

Sealing is achieved by means of an O-Ring, retaining washer and a properly machined port. The O-Ring is "captured" by the I.D. of the retaining washer. The port may be of the spot faced or a flat machined surface as long as the D6 dimension is met. For assembly instructions for adjustable type adapters page 26.

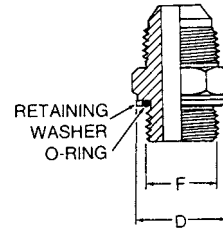
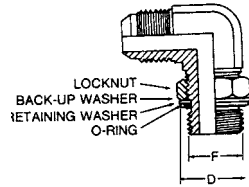

DIN 3852 large spot face

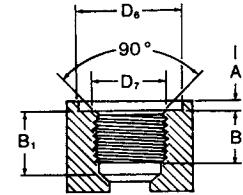

Equivalent to DIN 3852 form x

Thread size	M 10 x 1	M 12 x 1.5	M 14 x 1.5	M 16 x 1.5	M 18 x 1.5	M 20 x 1.5	M 22 x 1.5	M 26 x 1.5	M 27 x 2	M 33 x 2	M 42 x 2	M 48 x 2
F Thread Dia.	10.0	12.0	14.0	16.0	18.0	20.0	22.0	26.0	27.0	33.0	42.0	48.0
A max	1.0	1.5	1.5	1.5	2.0	2.0	2.5	2.5	2.5	2.5	2.5	2.5
B min (full thread)	12.0	12.0	12.0	12.0	12.0	14.0	14.0	16.0	16.0	18.0	20.0	22.0
B1 min	13.5	18.5	18.5	18.5	18.5	20.5	20.5	22.5	24.0	26.0	28.0	30.0
D max	15.7	18.7	19.7	23.2	26.2	28.2	30.2	35.2	36.2	43.2	52.7	58.7
D6 min	16.2	19.2	20.2	23.7	26.9	28.9	30.7	35.7	36.7	44.4	53.4	59.9
D7 max	10.2	12.2	14.2	16.2	18.2	20.2	22.2	26.2	27.2	33.3	42.3	48.3

BSPP (parallel) threads

Sealing is achieved by means of an O-Ring, retaining washer and a properly machined port.

The O-Ring is "captured" by the I.D. of the retaining washer. The compression is controlled by the thickness of the retaining washer.

The port may be of the spot faced or a flat machined surface as long as the D6 dimension is met.

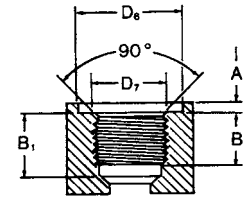
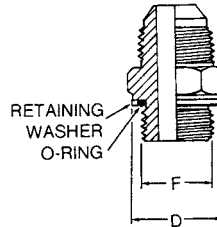
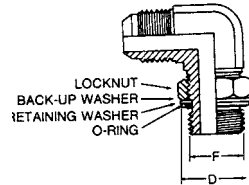

Thread size	G 1/8"-28		G 1/4"-19		G 3/8"-19		G 1/2"-14		G 3/4"-14		G 1"-11		G 1 1/4"-11		G 1 1/2"-11	
	mm	in	mm	in	mm	in	mm	in	mm	in	mm	in	mm	in	mm	in
F Thread Dia.	9,7	0.38	13,2	0.50	16,7	0.66	20,9	0.83	26,4	1.04	33,3	1.31	41,9	1.65	47,8	1.88
A max	1,0	0.04	2,0	0.08	2,05	0.10	2,5	0.10	2,5	0.10	2,5	0.10	2,5	0.10	2,5	0.10
B1 min (full thread)	8,0	0.31	12,0	0.47	12,0	0.47	14,0	0.63	16,0	0.63	18,0	0.71	20,0	0.79	22,0	0.87
B1 min	13,0	0.51	18,5	0.73	18,5	0.73	22,0	0.94	24,0	0.94	27,0	1.06	29,0	1.14	31,0	1.22
D max	15,7	0.62	19,7	0.78	24,0	0.94	28,7	1.38	35,2	1.38	43,2	1.70	52,7	2.07	58,7	2.31
D6 min	16,2	0.64	20,2	0.81	24,9	0.98	29,4	1.43	36,4	1.43	44,4	1.75	53,4	2.10	59,9	2.36
D7 max	10,0	0.39	13,4	0.53	16,9	0.67	21,2	1.05	26,7	1.05	33,6	1.32	42,3	1.67	48,2	1.90

BSPT (tapered) threads port sealing

Sealing is achieved by means of metal to metal deformation of the adapter and port threads.

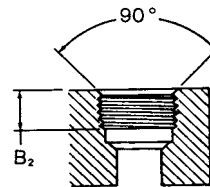

Thread size 11	R 1/8"-28		R 1/4"-19		R 3/8"-19		R 1/2"-14		R 3/4"-14		R 1"-11		R 1 1/4"-11		R 1 1/2"-11	
	mm	in	mm	in	mm	in	mm	in	mm	in	mm	in	mm	in	mm	in
B2 min (full thread)	5,5	0.22	8,5	0.33	8,5	0.33	10,5	0.41	13,0	0.51	14,5	0.57	17,0	0.67	17,0	0.67

Metric to SAE 37° flare

Metric 24° (DIN 3901/3902 I.Rh)/SAE 37° flare

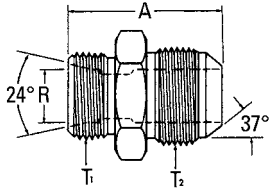

15.063-(Dash size)

(Formerly Weatherhead series MC5206x)

Dash size	Tube O.D.		Thread T1	Thread T2	A		Rø	
	mm	in			mm	in	mm	in
6-4	6,4	0.25	M12 x 1.5	7/16-20	31,0	1.22	6,0	0.24
8-6	9,7	0.38	M14 x 1.5	9/16-18	31,0	1.22	8,0	0.31
10-8	12,7	0.50	M16 x 1.5	3/4-16	34,5	1.36	10,0	0.39
12-8	12,7	0.50	M18 x 1.5	3/4-16	34,5	1.36	12,0	0.47
15-10	16,0	0.63	M22 x 1.5	7/8-14	39,1	1.54	15,0	0.59
18-12	19,0	0.75	M26 x 1.5	1 1/16-12	42,9	1.69	18,0	0.71
22-16	25,4	1.00	M30 x 2.0	1 5/16-12	46,0	1.81	22,0	0.87

Metric 24° (DIN 3902 s.Rh)/SAE 37° flare

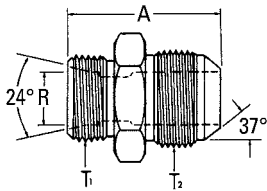

15.147-(Dash size)

(Formerly Weatherhead series MC5208x)

Dash size	Tube O.D.		Thread T1	Thread T2	A		Rø	
	mm	in			mm	in	mm	in
6-6	9,7	0.38	M14 x 1.5	9/16-18	33,0	1.30	6,0	0.24
10-8	12,7	0.50	M18 x 1.5	3/4-16	35,6	1.40	10,0	0.39
14-10	16,0	0.63	M22 x 1.5	7/8-14	40,4	1.59	14,0	0.55
16-12	19,0	0.75	M24 x 1.5	1 1/16-12	44,9	1.77	16,0	0.63
20-16	25,4	1.00	M30 x 2.0	1 5/16-12	48,0	1.89	20,0	0.79

Metric 60° (DIN 7631)/SAE 37° flare

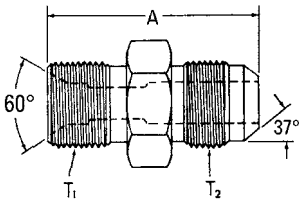

15.117-(Dash size)

(Formerly Weatherhead series MC5207x)

Dash size	Tube O.D.		Thread T1	Thread T2	A	
	mm	in			mm	in
4-4	6,3	0.25	M12X1.5	7/16-20	31,0	1.22
6-6	9,7	0.38	M14 x 1.5	9/16-18	31,0	1.22
8-6	9,7	0.38	M16 x 1.5	9/16-18	32,0	1.26
8-8	12,7	0.50	M16 x 1.5	3/4-16	34,5	1.36
10-8	12,7	0.50	M18 x 1.5	3/4-16	34,5	1.36
16-12	19,0	0.75	M26 x 1.5	1 1/16-12	42,9	1.69
20-16	50,8	2.00	M30X1,5	1 5/16-12	46,0	1.81
25-20	31,8	1.25	M38 x 1.5	1 5/8-12	47,5	1.87

Steel adapters

Metric to SAE 37° flare

Metric to SAE 37° flare

Metric 24° (DIN 3902 s.Rh)/SAE 37° flare

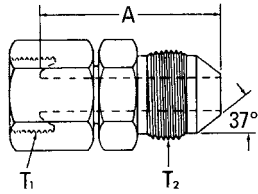

15.164-(Dash size)

Dash size	Tube O.D.		Thread T1	Thread T2	A	
	mm	in			mm	in
6-6	9,7	0.38	M14 x 1.5	9/16-18	35,1	1.38
10-8	12,7	0.50	M18 x 1.5	3/4-16	38,1	1.50
14-10	16,0	0.63	M22 x 1.5	7/8-14	40,9	1.61
16-12	19,0	0.75	M24 x 1.5	1 1/16-12	43,4	1.71
20-16	25,4	1.00	M30 x 2.0	1 5/16-12	47,0	1.85
30-24	38,1	1.50	M42 x 2.0	1 7/8-12	53,9	2.12

SAE 37° flare to metric
O-Ring port adapter (steel)

Includes O-ring

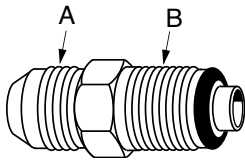

FF4215-(Dash size)

(Formerly Weatherhead series M41157x)

Dash size	Tube size	Thread A	Thread B
-0614S	3/8	9/16-18	M14X1.5
-0616S	3/8	9/16-18	M16X1.5
-0618S	3/8	9/16-18	M18X1.5

Includes O-Ring.

Metric 24° (DIN 3901/3902 I.Rh)/SAE 37° flare

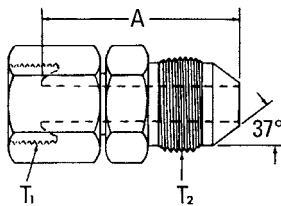

15.163-(Dash size)

Dash size	Tube O.D.		Thread T1	Thread T2	A	
	mm	in			mm	in
4-4 †	6,4	0.25	M12 x 1.5	7/16-20	34,5	1.36
6-6 †	9,7	0.38	M14 x 1.5	9/16-18	34,5	1.36
8-6 †	9,7	0.38	M16 x 1.5	9/16-18	35,6	1.40
8-8 †	12,7	0.50	M16 x 1.5	3/4-16	38,1	1.50
10-8 †	12,7	0.50	M18 x 1.5	3/4-16	38,1	1.50
13-10 †	16,0	0.63	M22 x 1.5	7/8-14	40,9	1.61
16-12 †	19,0	0.75	M26 x 1.5	1 1/16-12	47,5	1.87

†Universal fitting also mates with 60° DIN 7631/7647 connections.

For additional Metric 24° adapters please refer to Eaton's Walterscheid metric tube fittings catalog E-MEFI-MC002-E1 (or E-MEFI-MC001-M2 for the global version).

Metric to SAE 37° flare

Metric 60° (DIN 7631)/SAE 37° flare

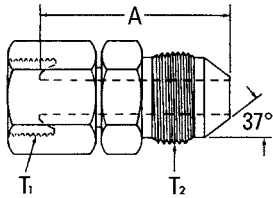

15.165-(Dash size)

Dash size	Tube O.D.		Thread T1	Thread T2	A	
	mm	in			mm	in
20-16	25,4	1.00	M30 x 1.5	1 5/16-12	46,0	1.81
25-20	31,7	1.25	M38 x 1.5	1 5/8-12	49,5	1.95
32-24	38,1	1.50	M45 x 1.5	1 7/8-12	52,6	2.07

SAE 37° male/DIN 3852 metric male

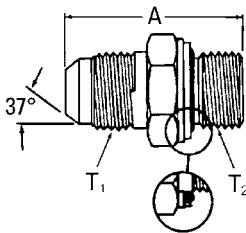

GG108-NP(Size)-(Dash size)

(Formerly Weatherhead series MC5315x)

Dash size	Tube O.D.		Thread T1	Thread T2	A	
	mm	in			mm	in
04-10	6,4	0.25	7/16-20	M10 x 1.0	29,0	1.14
04-12	6,4	0.25	7/16-20	M12 x 1.5	33,0	1.30
04-14	6,4	0.25	7/16-20	M14 x 1.5	34,0	1.34
05-10	7,9	0.31	1/2-20	M10 x 1.0	29,0	1.14
06-14	9,7	0.38	9/16-18	M14 x 1.5	34,0	1.34
06-16	9,7	0.38	9/16-18	M16 x 1.5	34,0	1.34
08-16	12,7	0.50	3/4-16	M16 x 1.5	37,1	1.46
08-18	12,7	0.50	3/4-16	M18 x 1.5	37,6	1.48
08-22	12,7	0.50	3/4-16	M22 x 1.5	40,1	1.58
10-18	16,0	0.63	7/8-14	M18 x 1.5	40,1	1.58
10-20	16,0	0.63	7/8-14	M20 x 1.5	42,9	1.69
10-22	16,0	0.63	7/8-14	M22 x 1.5	42,9	1.69
12-22	19,0	0.75	1 1/16-12	M22 x 1.5	46,5	1.83
12-27	19,0	0.75	1 1/16-12	M27 x 2.0	49,5	1.95
16-33	25,4	1.00	1 5/16-12	M33 x 2.0	53,6	2.11
20-42	31,8	1.25	1 5/8-12	M42 x 2.0	58,5	2.30

SAE 37° male 90° adjustable elbow/ DIN 3852 metric male

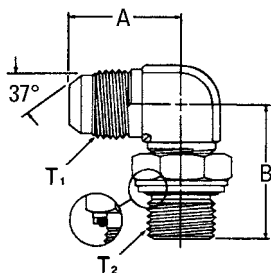

GG308-NP(Size)-(Dash size)

(Formerly Weatherhead series MC5515x)

Dash size	Tube O.D.		Thread T1	Thread T2	A		Rø	
	mm	in			mm	in	mm	in
04-10	6,4	0.25	7/16-20	M10 x 1	22,6	0.89	25,9	1.02
04-12	6,4	0.25	7/16-20	M12 x 1.5	26,9	1.06	31,5	1.24
06-14	9,7	9,7	9/16-18	M14 x 1.5	27,0	1.06	31,5	1.24
06-16	9,7	0.38	9/16-18	M16 x 1.5	28,5	1.12	36,6	1.44
08-18	12,7	0.50	3/4-16	M18 x 1.5	31,5	1.24	36,6	1.44
10-18	16,0	0.63	7/8-14	M18 x 1.5	36,6	1.44	39,6	1.56
10-20	16,0	0.63	7/8-14	M20 x 1.5	36,6	1.44	42,9	1.69
10-22	16,0	0.63	7/8-14	M22 x 1.5	36,6	1.44	42,9	1.69
12-22	19,0	0.75	1 1/16-12	M22 x 1.5	41,9	1.65	45,5	1.79
12-27	19,0	0.75	1 1/16-12	M27 x 2.0	41,9	1.65	49,0	1.93

Steel adapters

ORS to metric

ORS to metric

ORS – Special metric connector

(mates with DIN 3852 large spotface)

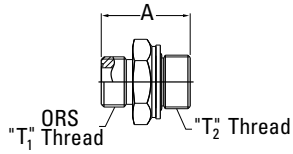

FF2485T(Dash size)

Dash size	Tube O.D.		Thread T1	Thread T2	Ref A	
	mm	in			mm	in
0818S	12,7	0.50	13/16-16	M18 x 1.5	33,6	1.32
0822S	12,7	0.50	13/16-16	M22 x 1.5	36,3	1.43

ORS/male ISO 6149 O-Ring seal

(S-series)

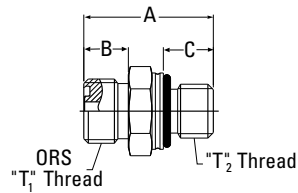

FF2742T(Dash size) (Ref. SAE 52M0187)

Dash size	Tube O.D.		Thread T1	Thread T2	A		B		C	
	mm	in			mm	in	mm	in	mm	in
0612S	9,7	0.38	11/16-16	M12 x 1.5	32,0	1.26	11,2	0.44	10,9	0.43
0614S	9,7	0.38	11/16-16	M14 x 1.5	32,0	1.26	11,2	0.44	10,9	0.43
0818S	12,7	0.50	13/16-16	M18 x 1.5	38,1	1.50	12,7	0.50	14,0	0.55
0822S	12,7	0.50	13/16-16	M22 x 1.5	39,4	1.55	12,7	0.50	15,0	0.59
1022S	16,0	0.63	1-14	M22 x 1.5	41,9	1.65	15,5	0.61	15,0	0.59
1222S	19,0	0.75	1 3/16-12	M22 x 1.5	43,4	1.71	17,0	0.67	15,0	0.59

90° ORS/ISO 6149 O-Ring seal

(S-series)

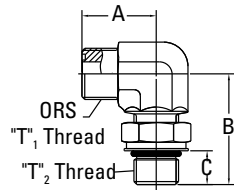

FF2744T(Dash size) (Ref. SAE 52M0287)

Dash size	Tube O.D.		Thread T1	Thread T2	A		B		C	
	mm	in			mm	in	mm	in	mm	in
0818S	12,7	0.50	13/16-16	M18 x 1.5	29,7	1.17	44,2	1.74	14,2	0.56

Metric sleeve

Sleeve 3-piece metric

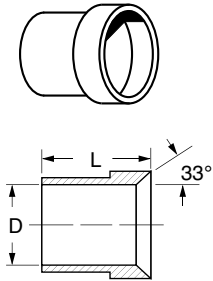

FF91488-(Dash size) (Ref. SAE 070115)
(Formerly Weatherhead series C5165x__M)

Dash size	Tube O.D.	D		L	
	in	mm	in	mm	in
-0406S	1/4	6,1	.241	10,4	.41
-0508S	5/16	8,1	.320	11,2	.44
-0610S	3/8	10,1	.399	12,7	.50
-0812S	1/2	12,1	.478	14,2	.56
-1014S	5/8	14,1	.556	16,8	.66
-1015S	5/8	15,1	.596	16,8	.66
-1016S	5/8	16,2	.636	16,8	.66
-1218S	3/4	18,2	.717	17,3	.68
-1420S	7/8	20,1	.793	19,3	.76
-2030S	1-1/4	30,2	1.191	23,1	.91
-2032S	1-1/4	32,3	1.270	23,1	.91

Adapts Standard SAE Flare-Twin® Hose Ends for use with metric tubing.

Pipe to metric

Female SAE 37° swivel to male metric taper pipe thread

(Pipe thread per DIN 3852)

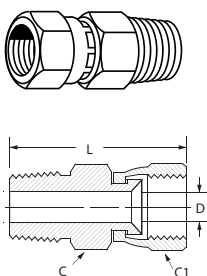

FF4180-(Dash size)
(Formerly Weatherhead series M9700x)

Dash size	Tube O.D	Taper pipe thread metric	Hex C		Hex C1		D		L	
			mm	in	mm	in	mm	in	mm	in
-0406S	1/4	M10x1.0	14,2	9/16	14,2	9/16	4,4	.172	31,8	1.25
-0508S	5/16	M12x1.5	17,5	11/16	15,9	5/8	5,9	.234	39,1	1.54
-0610S	3/8	M14x1.5	17,5	11/16	17,5	11/16	7,5	.297	40,6	1.60
-0812S	1/2	M16x1.5	22,2	7/8	22,2	7/8	9,9	.391	45,2	1.78
-1014S	5/8	M20x1.5	25,4	1	25,4	1	12,3	.484	48,5	1.91
-1220S	3/4	M24x1.5	28,6	1-1/8	28,6	1-1/8	15,4	.609	51,8	2.04
-1625S	1	M27x2.0	34,9	1-3/8	38,1	1-1/2	21,5	.845	58,4	2.30
-2032S	1-1/4	M36x2.0	47,6	1-7/8	50,8	2	27,4	1.079	61,7	2.43

Steel adapters

BSPP to SAE 37° flare

BSPP to SAE 37° flare

BSPP (parallel)/SAE 37° flare

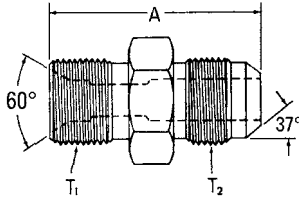

2063-(Dash size)

Dash size	Tube O.D.		Thread T1	Thread T2	A	
	mm	in			mm	in
2-4S	6,4	0.25	G 1/8-28	7/16-20	35,1	1.38
4-4S	6,4	0.25	G 1/4-19	7/16-20	35,1	1.38
4-5S	7,9	0.31	G 1/4-19	1/2-20	35,1	1.38
4-6S	9,7	0.38	G 1/4-19	9/16-18	35,1	1.38
6-6S	9,7	0.38	G 3/8-19	9/16-18	36,3	1.43
6-8S	12,7	0.50	G 3/8-19	3/4-16	38,9	1.53
8-8S	12,7	0.50	G 1/2-14	3/4-16	41,4	1.63
8-10S	16,0	0.63	G 1/2-14	7/8-14	43,9	1.73
10-12S	19,0	0.75	G 5/8-14	1 1/16-12	49,3	1.94
12-10S	16,0	0.63	G 3/4-14	7/8-14	47,7	1.88
12-12S	19,0	0.75	G 3/4-14	1 1/16-12	50,5	1.99
16-16S	25,4	1.00	G 1-11	1 5/16-12	53,1	2.09

Note: The BSPP male end mates with a BSPP female swivel nut. Use GG106 conversion adapters for port connections.

SAE 37° male/BSPP male

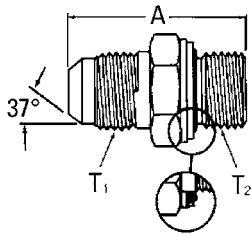

GG106-NP(Size)-(Dash size)

(Formerly Weatherhead series MB5315x)

Dash size	Tube O.D.		Thread T1	Thread T2	A	
	mm	in			mm	in
04-02	6,4	0.25	7/16-20	G1/8-28	29,0	1.14
04-04	6,4	0.25	7/16-20	G1/4-19	34,5	1.36
04-06	6,4	0.25	7/16-20	G3/8-19	34,5	1.36
04-08	6,4	0.25	7/16-20	G1/2-14	38,1	1.50
05-04	6,3	0.25	1/2-20	G1/4-19	34,5	1.36
06-04	9,7	0.38	9/16-18	G1/4-19	34,5	1.36
06-06	9,7	0.38	9/16-18	G3/8-19	34,5	1.36
06-08	9,7	0.38	9/16-18	G1/2-14	38,1	1.50
08-04	12,7	0.50	3/4-16	G1/4-19	37,6	1.48
08-06	12,7	0.50	3/4-16	G3/8-19	37,6	1.48
08-08	12,7	0.50	3/4-16	G1/2-14	40,9	1.61
08-12	12,7	0.50	3/4-16	G3/4-14	44,9	1.77
10-06	16,0	0.63	7/8-14	G3/8-19	40,4	1.59
10-08	16,0	0.63	7/8-14	G1/2-14	43,4	1.71
10-12	19,0	0.75	7/8-14	G 3/4-14	47,5	1.87
12-08	19,0	0.75	1 1/16-12	G1/2-14	47,0	1.85
12-12	19,0	0.75	1 1/16-12	G3/4-14	50,0	1.97
12-16	19,0	0.75	1 1/16-12	G1-11	52,6	2.07
16-12	25,4	1.00	1 1/16-12	G3/4-14	51,1	2.01
16-16	25,4	1.00	1 5/16-12	G1-11	53,6	2.11
16-20	25,4	1.00	1 5/16-12	G1 1/4-11	56,9	2.24
20-20	31,8	1.25	1 5/8-12	G1 1/4-11	58,4	2.30

BSPP to SAE 37° flare

90° adjustable elbow SAE 37° male/BSPP male adjustable

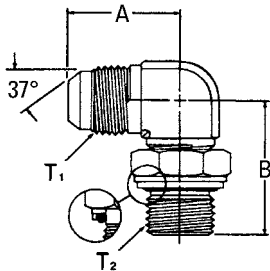

GG306-NP(Size)-(Dash size)

Dash size	Tube O.D.		Thread T1	Thread T2	A		B	
	mm	in			mm	in	mm	in
04-04	6,4	0.25	7/16-20	G1/4-19	26,9	1.06	31,5	1.24
05-04	7,9	0.31	1/2-20	G1/4-19	26,9	1.06	31,5	1.24
06-04	9,7	0.38	9/16-18	G1/4-19	26,9	1.06	31,5	1.24
06-06	9,7	0.38	9/16-18	G3/8-19	28,5	1.12	36,6	1.44
08-06	12,7	0.50	3/4-16	G3/8-19	31,5	1.24	36,6	1.44
08-08	12,7	0.50	3/4-16	G1/2-14	34,0	1.34	42,9	1.69
12-12	19,0	0.75	1 1/16-12	G3/4-14	41,9	1.65	49,0	1.93
16-16	25,4	1.00	1 5/16-12	G1-11	46,0	1.81	52,6	2.07
20-20	31,8	1.25	1 5/8-12	G1 1/4-11	52,0	2.05	56,9	2.24

SAE 37° female swivel/ BSPP male

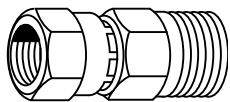

FF4179-(Dash size)

(Formerly Weatherhead series M9600x)

Dash size	Tube O.D.		BSPP pipe	Hex size		Hex C1		D		D1		L	
	mm	in		mm	mm	in	mm	in	mm	in	mm	in	mm
-0404S	6,4	1/4	G 1/4-19	14,3	9/16	14,3	9/16	4,4	.172	5,0	.198*	36,3	1.43
-0604S	9,7	3/8	G 1/4-19	17,5	11/16	17,5	11/16	7,5	.297	5,0	.198	39,6	1.56
-0606S	9,7	3/8	G 3/8-19	17,5	11/16	17,5	11/16	7,5	.297	8,4	.322*	42,2	1.66
-0806S	12,7	1/2	G 3/8-19	22,2	7/8	22,2	7/8	9,9	.391	8,4	.322	45,0	1.77
-0808S	12,7	1/2	G 1/2-14	22,2	7/8	22,2	7/8	9,9	.391	11,4	.448*	48,8	1.92
-1008S	15,9	5/8	G 1/2-14	25,4	1	25,4	1	12,3	.484	11,4	.448	50,0	1.97
-1212S	19,0	3/4	G 3/4-14	31,7	1-1/4	28,6	1-1/8	15,4	.609	16,9	.666*	55,9	2.25
-1616S	25,4	1	G 1-11	38,1	1-1/2	34,9	1-3/8	21,5	.845	22,5	.885*	62,9	2.48
-2020S	31,8	1-1/4	G 1-1/4-11	50,8	2	47,6	1-7/8	27,4	1.078	28,6	1.125*	67,1	2.64

*Optional counterbore.

BSPT to SAE 37° flare

SAE 37° male/BSPT male

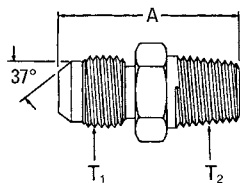

GG110-NP(Size)-(Dash size)

(Formerly Weatherhead series MC5205x)

Dash size	Tube O.D.		Thread T1	Thread T2	A	
	mm	in			mm	in
04-02	6,4	0.25	7/16-20	R1/8-28	29,0	1.14
04-04	6,4	0.25	7/16-20	R1/4-19	33,0	1.30
06-04	9,7	0.38	9/16-18	R1/4-19	33,6	1.32
06-06	9,7	0.38	9/16-18	R3/8-19	33,6	1.32
08-06	12,7	0.50	3/4-16	R3/8-19	36,6	1.44
08-08	12,7	0.50	3/4-16	R1/2-14	40,4	1.59
10-08	16,0	0.63	7/8-14	R1/2-14	42,9	1.69
12-08	19,0	0.75	1 1/16-12	R1/2-14	47,5	1.87
12-12	19,0	0.75	1 1/16-12	R3/4-14	49,5	1.95
16-16	25,4	1.00	1 5/16-12	R1-11	52,6	2.07

Steel adapters

BSPT to SAE 37° flare
JIS 30° to SAE 37° flare

BSPT to SAE 37° flare

90° elbow, SAE 37° male/BSPT male

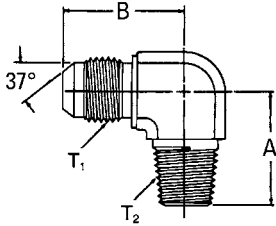

GG310-NP(Size)-(Dash size)
(Formerly Weatherhead series MC5405x)

Dash size	Tube O.D.		Thread T1	Thread T2	A		B	
	mm	in			mm	in	mm	in
04-04	6,4	0.25	7/16-20	R1/4-19	27,4	1.08	27,0	1.06
05-04	7,9	0.31	1/2-20	R1/4-19	27,4	1.08	27,0	1.06
06-04	9,7	0.38	9/16-18	R1/4-19	27,5	1.08	27,0	1.06
06-06	9,7	0.38	9/16-18	R3/8-19	31,0	1.22	28,5	1.12
06-08	9,7	0.38	9/16-18	R1/2-14	37,1	1.46	31,0	1.22
08-06	12,7	0.50	3/4-16	R3/8-19	31,0	1.22	31,5	1.24
08-08	12,7	0.50	3/4-16	R1/2-14	37,1	1.46	34,0	1.34
10-12	19,0	0.75	7/8-14	R3/4-14	40,5	1.59	39,5	1.55
12-12	19,0	0.75	1 1/16-12	R3/4-14	40,4	1.59	41,9	1.65
16-16	25,4	1.00	1 5/16-12	R1-11	50,0	1.97	46,0	1.81
20-20	31,7	1.25	1 5/8-12	R1 1/4-11	60,0	2.36	52,0	2.05

SAE 37° Female swivel to
BSPT male pipe thread

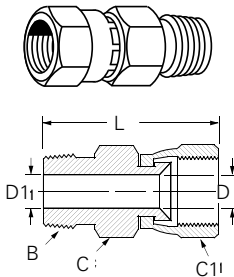

FF4181-(Dash size)
(Formerly Weatherhead series M9800x)

Dash size	Tube O.D.		BSPT pipe	Hex size		Hex C1		D		D1		L	
	mm	in		mm	in	mm	in	mm	in	mm	in	mm	in
-0404S	6,4	1/4	G 1/4-19	14,3	9/16	14,3	9/16	4,4	.172	7,1	.281*	39,6	1.56
-0504S	7,9	5/16	G 1/4-19	17,5	11/16	15,9	5/8	5,9	.234	7,1	.281*	41,4	1.63
-0604S	9,7	3/8	G 1/4-19	17,5	11/16	17,5	11/16	7,5	.297	7,1	.281	42,9	1.69
-0804S	12,7	1/2	G 1/4-19	22,2	7/8	22,2	7/8	9,9	.391	7,1	.281	47,5	1.87
-0806S	12,7	1/2	G 3/8-19	22,2	7/8	22,2	7/8	9,9	.391	10,3	.406*	47,5	1.87
-0808S	12,7	1/2	G 1/2-14	22,2	7/8	22,2	7/8	9,9	.391	13,5	.531*	52,3	2.06
-1008S	16,0	5/8	G 1/2-14	25,4	1	25,4	1	12,3	.484	13,5	.531*	53,6	2.11
-1208S	19,0	3/4	G 1/2-14	28,6	1 1/8	31,7	1 1/4	15,5	.609	13,5	.531	56,1	2.21
-1212S	19,0	3/4	G 3/4-14	28,6	1 1/8	31,7	1 1/4	15,5	.609	18,3	.719*	56,9	2.24
-1612S	25,4	1	G 3/4-14	34,9	1 3/8	38,1	1 1/2	21,5	.845	18,3	.719	60,7	2.39
-1616S	25,4	1	G 1-11	34,9	1 3/8	38,1	1 1/2	21,5	.845	23,8	.938*	64,8	2.55
-2020S	38,1	1-1/4	G 1 1/4-11	47,6	1 7/8	50,8	2	27,4	1.079	28,6	1.125*	69,3	2.73

*Optional counterbore.

JIS 30° to SAE 37° flare

JIS 30° Female cone seat/SAE 37° Male

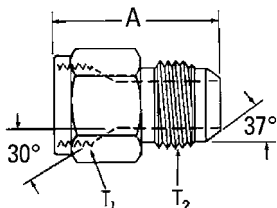

FF2593-(Dash size)

Dash size	Tube O.D.		Thread T1	Thread T2	A	
	mm	in			mm	in
0404S	6,4	0.25	G1/4-19	7/16-20	30,3	1.19
0606S	9,7	0.38	G3/8-19	9/16-18	30,7	1.21
0808S	12,7	0.50	G1/2-14	3/4-16	35,8	1.41
1212S	19,0	0.75	G3/4-14	1 1/16-12	43,2	1.70

7000 series Ermeto

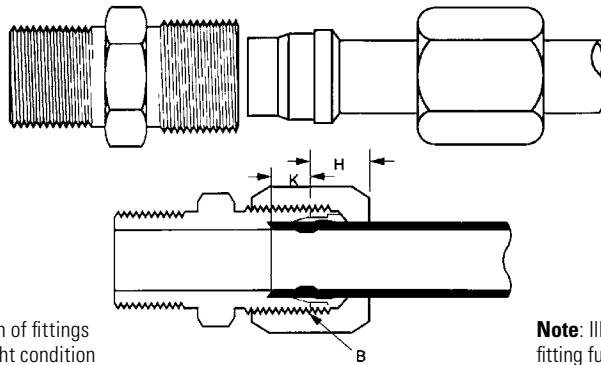

Note: "H" is dimension of fittings assembled to hand tight condition

Note: Illustration shows fitting fully assembled.

Tube O.D.	1/8	3/16	1/4	5/16	3/8	1/2	5/8	3/4	7/8	1	1 1/4	1 1/2	2
Thread size-B	5/16-24	3/8-24	7/16-20	1/2-20	9/16-18	3/4-16	7/8-14	1 1/16-12	1 3/16-12	1 5/16-12	1 5/8-12	1 7/8-12	2 1/2-12
Seat depth-K	0.19	0.24	0.24	0.26	0.26	0.31	0.36	0.36	0.36	0.42	0.42	0.49	0.49
H (Ref.)	0.31	0.30	0.39	0.41	0.47	0.48	0.53	0.55	0.53	0.63	0.56	0.61	0.64

Typical application

Hydraulic, instrumentation and chemical processing systems. Highly recommended for high pressure applications

Pressure

Operating pressure up to 10,000 psi depending on tube and fitting size.

Vibration

Excellent resistance

Temperature range

-65°F to +400°F (-53°C to +204°C) at maximum operating pressures. Has been used at 800°F and 1000 psi to 4000 psi depending on tube size.

Material

Carbon steel plating - Zinc Trivalent

Advantages

An excellent high pressure fitting - NO TUBE FLARING. Used with extra heavy wall tubing. Broad selection of sizes and styles.

Conformance

Meets specifications and standards of ASME and SAE.

How to order

For complete assembly (body, nut sleeve) order individually by part number. Example: 7205x4.

To order body only (less nut and sleeve), prefix the part number with the letter 'B'. Example: B7205X4.

Nuts and sleeves can be ordered separately by part number.

Steel adapters

7000 series Ermeto fittings

7000 series Ermeto fittings

Ermeto fittings (7000 Series) are especially designed for making leak-proof tube connections. This fitting will effectively withstand high pressure, severe vibration and extreme temperature. No special tools are needed for assembly. Simply cut tube square, preset sleeve on tubing and assemble.

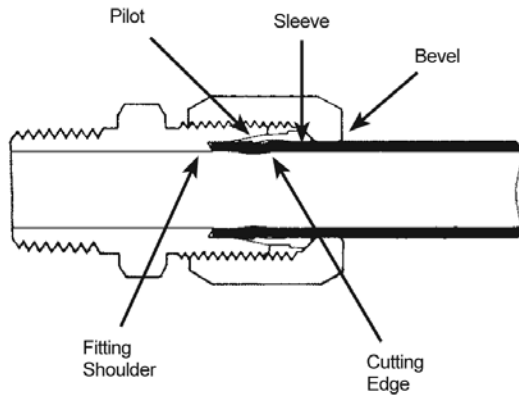

7000 series fittings

Specifically designed to meet all SAE approved standards for hydraulic flareless tube fittings. Available in a complete range of standard body styles.

Carbon steel 7000 series

Eaton Ermeto fittings have a zinc trivalent finish, which fully resists the effects of nonflammable hydraulic fluids.

Ermeto design principle provides positive seal

1. In presetting, as the nut is tightened it forces the sleeve forward into the body taper. See page 145 for preset instructions.
2. Pilot of sleeve contracts, forcing the cutting edge of sleeve to shear a groove into outer surface of the tube, making a tight joint between fitting and tube.
3. In assembling the preset sleeve and tube into the fitting body, the nut presses on the bevel at rear of sleeve causing it to clamp tightly to the tube. Resistance to vibration is concentrated at this point rather than at the sleeve cut.
4. When fully tightened, the case hardened sleeve is bowed slightly at the midsection and acts as a spring. This spring action of the sleeve maintains a constant tension between the body and the nut, and thus prevents the nut from loosening.
5. After the first assembly, the sleeve is permanently attached to the tube. Disassembly and reassembly of the fitting can be made without loss of strength or sealing qualities.

In general, the "bite-action" of the sleeves in any given material varies as shown in the following table:

"7000" Series Sleeve	Sleeve Material	Tubing used 303 to 316 Stainless and Cupro-Nickel	"Bite-action"
7165	Heat treated carbon steel (Standard carbon)	Fully annealed to 1/8 hard	Excellent

7000 series Ermeto fittings assembly instructions

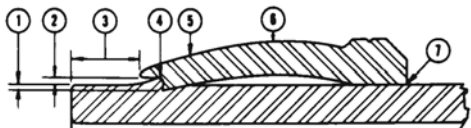
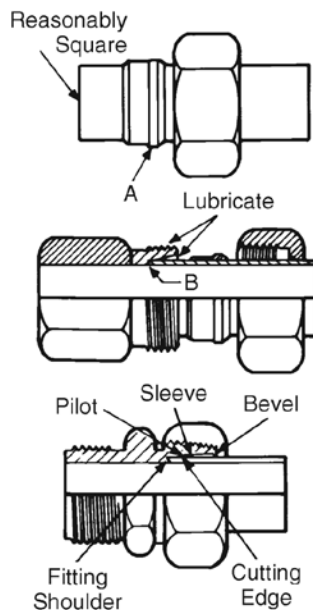

Presetting operation

Preset with preset tool:

1. Slide nut and then sleeve on tube. Shoulder of sleeve "A" must be toward nut.
2. Insert tube into presetting tool. Be sure that tube is bottomed on fitting tube stop at point "B". Lubricate threads, seat of fitting and shoulder of sleeve with good grade of lubricant.
3. Turn nut slowly with wrench while turning tube with other hand. When the sleeve grips the tube, that is, when the tube can no longer be turned by hand - STOP - and note the position of the wrench. This is the "Ring Grip" point.
4. Tighten nut an additional number of turns past the ring grip point per tube size and wall thickness as shown in Table 1, page 142.
5. Disassemble from preset tool.

Preset in fitting body:

Follow same procedure as when presetting with preset tool. Once the fitting nut has been turned the proper number of turns past ring grip, the fitting assembly is complete and ready for use.

Fitting installation

1. After sleeve and nut have been preset on the tubing and checked as described, the assembly is ready for installation into the Ermeto fitting seat.
2. Lubricate threads, seat of fitting and shoulder of sleeve with a good grade of lubricant compatible with system fluid.
3. Insert tube assembly into fitting and tighten nut until sharp rise in torque is felt.
4. Starting at the position of sharp torque rise, tighten nut 1/4 turn to complete assembly.

When the assembly procedure for Ermeto fittings is followed correctly, these points will be evident:

1. Cutting edge of sleeve will be imbedded in tubing to its full depth.
2. Pilot edge of sleeve should be close to or touching O.D. of tubing.
3. Distance between end of tube and leading or pilot edge of sleeve will be at least 1/8".
4. Metal will be piled ahead of cutting edge of sleeve under pilot.
5. Contact area of sleeve will show evidence of being in perfect contact with tapered seat of fitting.
6. Sleeve will show evidence of being bowed within its elastic limits.
7. Back of sleeve will be in contact with tube.

Note: Performance of fitting will not be affected if sleeve rotates on tube after disassembly.

For re-installation of fitting after disassembly

1. Insert tube assembly into fitting, tighten nut until a sharp rise in torque is felt.
2. Starting at the position of sharp torque rise, tighten nut 1/4 turn to complete the re-installation.

Steel adapters

Presetting Ermeto fittings

Presetting Ermeto fittings

Table 1: Number of additional turns from “Ring grip” for hand presetting operation–Ermeto sleeve

Tube Size	Tube Material**	Tube wall thickness									
		.018	.022	.028	.035	.049	.065	.083	.095	.109	.120
2	C 1010	1-1/6	1-1/6	1-1/6	1-1/6						
	MiL-T-8504	1-1/6	1-1/6	1-1/6	1-1/6						
3	C 1010	1-1/6	1-1/6	1-1/6	1						
	MiL-T-8504	1-1/6	1-1/6	1-1/6	1						
4	C 1010			1-1/6	1-1/6	1-1/6	1				
	MiL-T-8504			1-1/6	1	1	5/6				
5	C 1010			1-1/6	1-1/6	1-1/6	1				
	MiL-T-8504			1-1/6	1-1/6	1	1				
6	C 1010				1-1/6	1-1/6	1	1			
	MiL-T-8504				1-1/6	5/6	5/6	1			
8	C 1010				1-1/6	1-1/6	1	1	1		
	MiL-T-8504				1-1/6	1	5/6	5/6	5/6		
10	C 1010					1-1/6	1	5/6	5/6	5/6	5/6
	MiL-T-8504					1-1/6	1	5/6	5/6	5/6	5/6
12	C 1010					1	1	5/6	5/6	5/6	
	MiL-T-8504					1-1/6	1	5/6	5/6	5/6	
16	C 1010					1-1/6	1-1/6	5/6	5/6	5/6	
	MiL-T-8504					1-1/6	1-1/6	5/6	5/6	5/6	
20	C 1010					1-1/6	1	1	1	5/6	5/6
	MiL-T-8504					1	1	1	1	5/6	5/6
24	C 1010								1	1	1
	MiL-T-8504								1	1	1
32	C 1010								1	1	1
	MiL-T-8504								1	1	1

** C 1010 – carbon steel tubing

** MiL-T-8504 – Annealed stainless steel

Ermeto hand presetting tools 7000 series



Presetting tools provide a more accurate and positive leak-proof method of coupling flareless fittings. Presetting steel Ermeto sleeves on tubing prior to fitting assembly will permit the maximum high performance obtainable with flareless fittings.

Catalog number	Tube O.D.	Thread size
	inches	
T-7002	1/8	5/16-24
T-7003	3/16	3/8-24
T-7004	1/4	7/16-20
T-7005	5/16	1/2-20
T-7006	3/8	9/16-18
T-7008	1/2	3/4-16
T-7010	5/8	7/8-14
T-7012	3/4	1 1/16-12
T-7016	1	1 5/16-12
T-7020	1 1/4	1 5/8-12
T-7024	1 1/2	1 7/8-12
T-7032	2	2 1/2-12

Ermeto flareless fittings

Hydraulic pressure data

Ermeto fittings have been used with success on many and varied applications far exceeding the conservative conditions presented below. Specifically:

- Temperatures up to 800°F, in carbon steel have been handled without failure
- Burst pressures up to 32,000 psi with 1/4" tubing
- Vibration conditions of 1/8" off-center amplitude with 12" overhang in 1/4" tubing have been withstood at rated operating pressure with 4-to-1 safety factors for over ten million cycles

Obviously under extreme conditions of pressure, temperature and/or vibration, the safety factor is proportionately reduced.

The Ermeto flareless fitting is the ultimate hydraulic fitting available today. Special performance conditions as outlined can be accommodated; however, it is recommended that your local Eaton representative be consulted for engineering assistance prior to finalizing design.

The values shown in the following table are pressure ratings of Ermeto flareless fittings under various surge conditions. They apply and are recommended for conservative operating conditions.

Size no.	Size in inches	Maximum pressure † No surges PSI	Maximum pressure † With surges to 50%	Maximum pressure † With surges of 50% to 100%	Maximum pressure † With surges to 150%
2	1/8	10,000	6,500	5,000	4,000
3	3/16	9,000	6,000	4,500	3,600
4	1/4	8,000	5,250	4,000	3,200
5	5/16	8,000	5,250	4,000	3,200
6	3/8	7,500	5,000	3,750	3,000
8	1/2	7,000	4,500	3,500	2,700
10	5/8	5,000	3,250	2,500	2,000
12	3/4	5,000	3,250	2,500	2,000
14	7/8	3,750	2,500	1,800	1,500
16	1	3,600	2,400	1,800	1,400
20	1 1/4	3,200	2,100	1,600	1,275
24	1 1/2	3,000	2,000	1,500	1,200
32	2	2,750	1,800	1,350	1,100

†Pressures shown do not apply to pneumatic applications.

Steel adapters

Ermeto

Ermeto

Sleeve

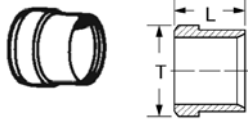

7165x (Ref. SAE No. 080115B)

Part number	Tube O.D.	L	Dia. T
7165x2	1/8	0.28	0.20
7165x3	3/16	0.28	0.31
7165x4	1/4	0.34	0.36
7165x5	5/16	0.34	0.42
7165x6	3/8	0.38	0.48
7165x8	1/2	0.38	0.63
7165x10	5/8	0.42	0.75
7165x12	3/4	0.42	0.88
7165x14	7/8	0.42	1.00
7165x16	1	0.42	1.13
7165x20	1 1/4	0.42	1.41
7165x24	1 1/2	0.42	1.66
7165x32	2	0.45	2.19

Sleeve

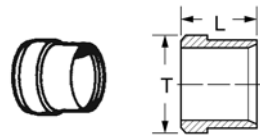

8165x

Part number	Tube O.D.	L	Dia. T
8165x4	1/4	0.34	0.38
8165x5	5/16	0.34	0.44
8165x6	3/8	0.38	0.50

For use with 8112x diesel nuts only.

Nut

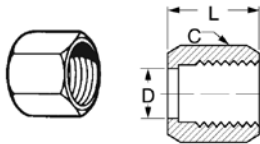

7105x (Ref. SAE No. 080110)

Part number	Tube O.D.	Hex C	L	D Dia
7105x2	1/8	3/8	0.53	0.132
7105x3	3/16	7/16	0.61	0.195
7105x4	1/4	9/16	0.70	0.257
7105x5	5/16	5/8	0.72	0.320
7105x6	3/8	1 1/16	0.75	0.382
7105x8	1/2	7/8	0.84	0.508
7105x10	5/8	1	0.92	0.634
7105x12	3/4	1 1/4	0.97	0.759
7105x14	7/8	1 3/8	1.00	0.884
7105x16	1	1 1/2	1.05	1.009
7105x20	1 1/4	2	1.05	1.263
7105x24	1 1/2	2 1/4	1.03	1.513
7105x32	2	2 7/8	1.12	2.017

Diesel nut

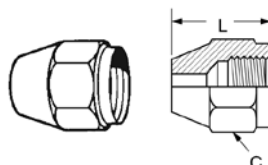

8112x

Part number	Tube O.D.	Thread number	Hex C	L
8112x4	1/4	9/16-18	3/4	.94
8112x5	5/16	5/8-18	1 3/16	1.00
8112x6	3/8	3/4-16	1 5/16	1.13

For use with 8165x sleeve only.

Note: All measurements are in inches.

Ermeto

Cap

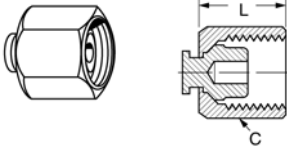

7129x (Ref. SAE No. 080112)

Part number	Tube O.D	Hex C	L
7129x4	1/4	9/16	0.70
7129x6	3/8	1 1/16	0.75
7129x8	1/2	7/8	0.84
7129x10	5/8	1	0.92
7129x12	3/4	1 1/4	0.97
7129x16	1	1 1/2	1.05
7129x20	1 1/4	2	1.05

Plug

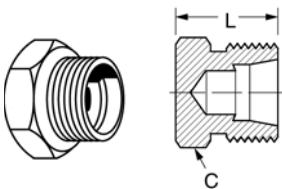

7229x (Ref. SAE No. 080109)

Part number	Tube O.D	Hex C	L
7229x2	1/8	7/16	0.63
7229x4	1/4	1/2	0.71
7229x5	5/16	9/16	0.71
7229x6	3/8	5/8	0.75
7229x8	1/2	1 3/16	0.85
7229x10	5/8	1 5/16	0.97
7229x12	3/4	1 1/8	1.10
7229x16	1	1 3/8	1.10

Reducer

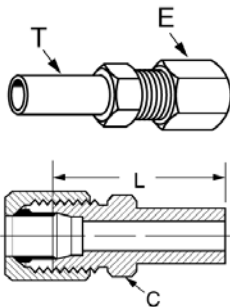

7015x (Ref. SAE No. 080123)

Part number	Body size T	Tube size	Hex C	L
7015x6x4	3/8	1/4	1/2	1.61
7015x8x4	1/2	1/4	9/16	1.73
7015x8x6	1/2	3/8	5/8	1.77
7015x10x8	5/8	1/2	1 3/16	1.96
7015x12x6	3/4	3/8	1 3/16	1.93
7015x12x8	3/4	1/2	1 3/16	2.03
7015x20x16	1 1/4	1	1 3/8	2.28

Note: All measurements are in inches.

Steel adapters

Ermeto

Ermeto

Small hex union

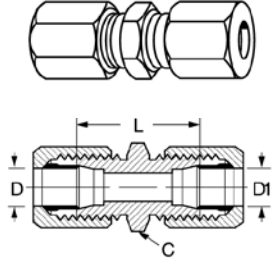

7305x (Ref. SAE No. 080101)

Part number	Tube O.D.	Hex C	D	D1	L
7305x2	1/8	7/16	0.093	0.093	1.02
7305x3	3/16	7/16	0.125	0.125	1.11
7305x4	1/4	1/2	0.203	0.203	1.18
7305x5	5/16	9/16	0.234	0.234	1.18
7305x6	3/8	5/8	0.281	0.281	1.24
7305x6x4	3/8 & 1/4	5/8	0.281	0.203	1.22
7305x8	1/2	13/16	0.422	0.422	1.42
7305x8x6	1/2 & 3/8	13/16	0.422	0.281	1.33
7305x10	5/8	15/16	0.500	0.500	1.61
7305x12	3/4	1 1/8	0.656	0.656	1.81
7305x14	7/8	1 1/4	0.718	0.718	1.81
7305x16	1	1 3/8	0.875	0.875	1.81
7305x20	1 1/4	1 11/16	1.093	1.093	1.89
7305x24	1 1/2	2	1.344	1.344	1.96

Large hex union

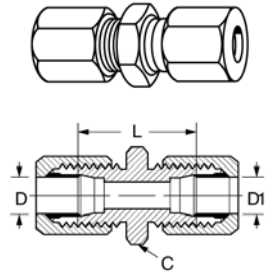

7306x (Ref. SAE No. 080119)

Part number	Tube O.D.	Hex C	D	D1	L
7306x4	1/4	11/16	0.203	0.203	1.18
7306x6	3/8	13/16	0.281	0.281	1.24
7306x8	1/2	1	0.422	0.281	1.33
7306x8x6	1/2 & 3/8	1	0.422	0.422	1.42
7306x12	3/4	1 3/8	0.656	0.656	1.81
7306x16	1	1 5/8	0.875	0.875	1.81

Bulkhead union

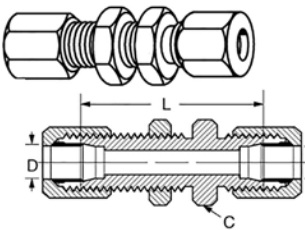

7325x (Ref. SAE No. 080601)

Bulkhead nut included, for replacement nuts use 210212-

Part number	Tube O.D.	Hex C	D	L
7325x4	1/4	11/16	0.203	1.89
7325x6	3/8	13/16	0.281	1.98
7325x8	1/2	1	0.422	2.22
7325x12	3/4	1 3/8	0.656	2.72
7325x16	1	1 5/8	0.875	2.72

Note: All measurements are in inches.

Ermeto

Male connector

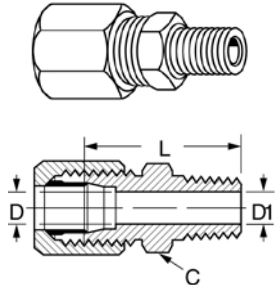

7205x (Ref. SAE No. 080102)

Part number	Tube O.D.	Male pipe thread	Hex C	D1 D	Opt.	L
7205x2	1/8	1/8-27	7/16	0.093	0.188	1.04
7205x2X4	1/8	1/4-18	9/16	0.093	0.281	1.25
7205x3	3/16	1/8-27	7/16	0.125	0.188	1.09
7205x4	1/4	1/8-27	1/2	0.203	0.188	1.12
7205x4X4	1/4	1/4-18	9/16	0.203	0.281	1.32
7205x4X6	1/4	3/8-18	3/4	0.203	0.406	1.33
7205x4X8	1/4	1/2-14	7/8	0.203	0.531	1.58
7205x5	5/16	1/8-27	9/16	0.234	0.188	1.12
7205x5X4	5/16	1/4-18	9/16	0.234	0.281	1.32
7205x6	3/8	1/4-18	5/8	0.281	0.281	1.34
7205x6X2	3/8	1/8-27	5/8	0.281	0.188	1.15
7205x6X6	3/8	3/8-18	3/4	0.281	0.406	1.35
7205x6X8	3/8	1/2-14	7/8	0.281	0.531	1.60
7205x8	1/2	3/8-18	13/16	0.422	0.406	1.44
7205x8X4	1/2	1/4-18	13/16	0.422	0.281	1.44
7205x8X8	1/2	1/2-14	7/8	0.422	0.531	1.69
7205x8X12	1/2	3/4-14	1 1/8	0.422	0.719	1.76
7205x10	5/8	1/2-14	15/16	0.500	0.531	1.75
7205x10X6	5/8	3/8-18	15/16	0.500	0.406	1.56
7205x12	3/4	1/2-14	1 1/8	0.656	0.531	1.88
7205x12X8	3/4	3/4-14	1 1/8	0.656	0.719	1.88
7205x14	7/8	3/4-14	1 1/4	0.718	0.719	1.88
7205x16	1	1-11 1/2	1 3/8	0.875	0.938	2.07
7205x16X12	1	3/4-14	1 3/8	0.875	0.719	1.88
7205x20	1 1/4	1 1/4-11 1/2	1 11/16	1.093	1.250	2.18
7205x24	1 1/2	1 1/2-11 1/2	2	1.344	1.500	2.28

Female connector

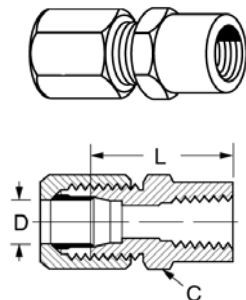

7255x (Ref. SAE No. 080103)

Part number	Tube O.D.	Female pipe thread	Hex C	D	L
7255x2	1/8	1/8-27	9/16	0.093	1.05
7255x3	3/16	1/8-27	9/16	0.125	1.08
7255x4	1/4	1/8-27	9/16	0.203	1.09
7255x4x4	1/4	1/4-18	3/4	0.203	1.20
7255x5	5/16	1/8-27	9/16	0.234	1.08
7255x6	3/8	1/4-18	3/4	0.281	1.31
7255x6x6	3/8	3/8-18	7/8	0.281	1.40
7255x8	1/2	3/8-18	7/8	0.422	1.47
7255x8x4	1/2	1/4-18	7/8	0.422	1.38
7255x8x8	1/2	1/2-14	1 1/8	0.422	1.63
7255x10	5/8	1/2-14	1 1/8	0.500	1.76
7255x12	3/4	3/4-14	1 3/8	0.656	1.89
7255x14	7/8	3/4-14	1 3/8	0.718	1.86
7255x16	1	1-11 1/2	1 5/8	0.875	2.13
7255x20	1 1/4	1 1/4-11 1/2	2	1.093	2.22

Note: All measurements are in inches.

Steel adapters

Ermeto

Ermeto

Straight thread O-Ring connector

7315x (Ref. SAE No. 080120)

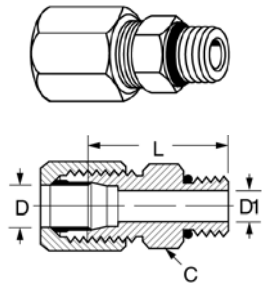

Part number	Tube O.D.	Port size	Hex C	D	L	D1 opt.
7315x4	1/4	1/4	9/16	0.203	1.13	-
7315x4x5	1/4	5/16	5/8	0.203	1.13	-
7315x4x6	1/4	3/8	11/16	0.203	1.19	0.281
7315x5	5/16	5/16	5/8	0.234	1.13	-
7315x6	3/8	3/8	11/16	0.281	1.21	-
7315x6x8	3/8	1/2	7/8	0.281	1.29	0.422
7315x8	1/2	1/2	7/8	0.422	1.38	-
7315x8x10	1/2	5/8	1	0.422	1.51	0.500
7315x8x12	1/2	3/4	1 1/4	0.422	1.67	0.656
7315x10	5/8	5/8	1	0.500	1.57	-
7315x12	3/4	3/4	1 1/4	0.656	1.79	-
7315x16	1	1	1 1/2	0.875	1.82	-
7315x16x12	1	3/4	1 1/2	0.875	1.82	0.656
7315x20	1 1/4	1 1/4	1 7/8	1.093	1.90	-

45° male elbow

7355x (Ref. SAE No. 080302)

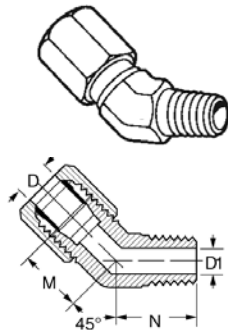

Part number	Tube O.D.	Male pipe thread	D	D1	M	N	Across flats
7355x4x4	1/4	1/4-18	0.203	0.281	0.83	0.86	9/16
7355x6	3/8	1/4-18	0.281	0.281	0.83	0.86	9/16
7355x8	1/2	3/8-18	0.422	0.406	0.98	0.95	3/4
7355x10	5/8	1/2-14	0.500	0.531	1.08	1.17	7/8
7355x12	3/4	3/4-14	0.656	0.719	1.27	1.20	1 1/16
7355x16	1	1-11 1/2	0.875	0.938	1.36	1.48	1 5/16

90° union elbow

7505x (Ref. SAE No. 080201)

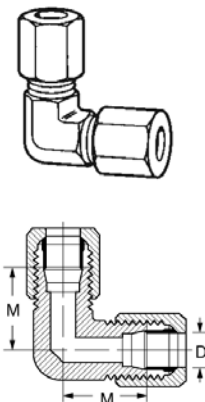

Part number	Tube O.D.	D	M	Across flats
7505x4	1/4	0.203	0.89	7/16
7505x5	5/16	0.234	0.95	1/2
7505x6	3/8	0.281	1.05	9/16
7505x8	1/2	0.422	1.25	3/4
7505x10	5/8	0.500	1.42	7/8
7505x12	3/4	0.656	1.58	1 1/16
7505x14	7/8	0.718	1.66	1 5/16
7505x16	1	0.875	1.73	1 5/16
7505x20	1 1/4	1.093	1.89	1 5/8
7505x24	1 1/2	1.346	2.02	1 7/8

Note: Available in stainless steel. All measurements are in inches.

Ermeto

90° male elbow

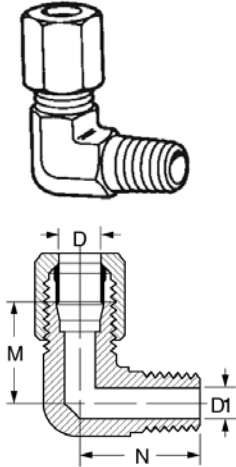

7405x (Ref. SAE No. 080202)

Part number	Tube O.D.	Male Pipe thread	D	D1	M	N	Across flats
7405x2	1/8	1/8-27	0.093	0.188	0.77	0.72	7/16
7405x3	3/16	1/8-27	0.125	0.188	0.83	0.72	7/16
7405x4	1/4	1/8-27	0.203	0.188	0.89	0.78	7/16
7405x4x4	1/4	1/4-18	0.203	0.281	1.03	1.09	9/16
7405x5	5/16	1/8-27	0.234	0.188	0.95	0.81	1/2
7405x5x4	5/16	1/4-18	0.234	0.281	1.03	1.09	9/16
7405x6	3/8	1/4-18	0.281	0.281	1.05	1.09	9/16
7405x6x2	3/8	1/8-27	0.281	0.188	1.05	0.90	9/16
7405x6x6	3/8	3/8-18	0.281	0.406	1.16	1.22	3/4
7405x6x8	3/8	1/2-14	0.281	0.531	1.24	1.47	7/8
7405x8	1/2	3/8-18	0.422	0.406	1.25	1.22	3/4
7405x8x4	1/2	1/4-18	0.422	0.281	1.25	1.22	3/4
7405x8x8	1/2	1/2-14	0.422	0.531	1.35	1.47	7/8
7405x10	5/8	1/2-14	0.500	0.531	1.42	1.47	7/8
7405x10x6	5/8	3/8-18	0.500	0.406	1.42	1.28	7/8
7405x12	3/4	3/4-14	0.656	0.719	1.58	1.59	1 1/16
7405x12x8	3/4	1/2-14	0.656	0.531	1.58	1.59	1 1/16
7405x14	7/8	3/4-14	0.718	0.719	1.62	1.69	1 5/16
7405x16	1	1-11 1/2	0.875	0.938	1.73	1.97	1 5/16
7405x16x12	1	3/4-14	0.875	0.719	1.73	1.78	1 5/16
7405x20	1 1/4	1 1/4-11 1/2	1.093	1.250	1.89	2.38	1 5/8
7405x24	1 1/2	1 1/2-11 1/2	1.344	1.500	2.02	2.64	1 7/8

90° female elbow

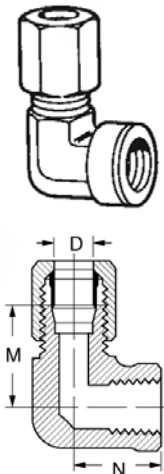

7455x (Ref. SAE No. 080203)

Part number	Tube O.D.	Female Pipe thread	D	M	N	Across flats
7455x4	1/4	1/8-27	0.203	0.89	0.66	9/16
7455x4x4	1/4	1/4-18	0.203	1.03	0.88	3/4
7455x6	3/8	1/4-18	0.281	1.05	0.88	3/4
7455x6x6	3/8	3/8-18	0.281	1.14	1.02	7/8
7455x8	1/2	3/8-18	0.422	1.23	1.02	7/8
7455x8x8	1/2	1/2-14	0.422	1.35	1.23	1 1/16
7455x10	5/8	1/2-14	0.500	1.42	1.23	1 1/16
7455x12	3/4	3/4-14	0.656	1.58	1.36	1 5/16
7455x14	7/8	3/4-14	0.718	1.66	1.42	1 5/16
7455x16	1	1-11 1/2	0.875	1.73	1.62	1 5/8

Note: All measurements are in inches.

Steel adapters

Ermeto

Ermeto

90° elbow - straight thread O-Ring

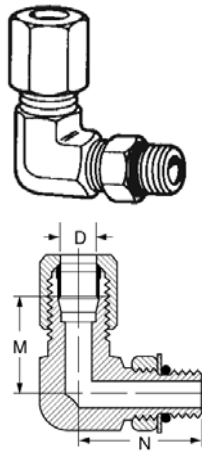

7515x (Ref. SAE No. 080220)

Part number	Tube O.D.	Port size	D	M	N	Across flats
7515x4	1/4	1/4	0.203	0.89	1.03	7/16
7515x5	5/16	5/16	0.234	0.96	2.13	9/16
7515x6	3/8	3/8	0.281	1.05	1.25	9/16
7515x8	1/2	1/2	0.422	1.25	1.45	3/4
7515x10	5/8	5/8	0.500	1.42	1.70	7/8
7515x12	3/4	3/4	0.656	1.58	1.94	1 1/16
7515x16	1	1	0.875	1.73	2.05	1 5/16
7515x20	1 1/4	1 1/4	1.093	1.89	2.25	1 5/8

Union tee

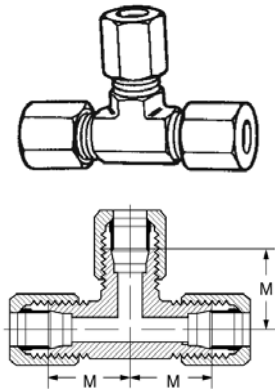

7705x (Ref. SAE No. 080401)

Part number	Tube O.D.	D	M	Across flats
7705x3	3/16	0.125	0.83	7/16
7705x4	1/4	0.203	0.89	7/16
7705x5	5/16	0.234	0.95	9/16
7705x6	3/8	0.281	1.05	9/16
7705x8	1/2	0.422	1.25	3/4
7705x10	5/8	0.500	1.42	7/8
7705x12	3/4	0.656	1.58	1 1/16
7705x14	7/8	0.718	1.62	1 5/16
7705x16	1	0.875	1.73	1 5/16

Male run tee

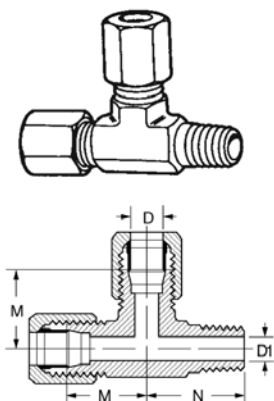

7755x (Ref. SAE No. 080424)

Part number	Tube O.D.	Male pipe thread	D	D1	M	N	Across flats
7755x4	1/4	1/8-27	0.203	0.188	0.89	0.78	7/16
7755x4x4x4	1/4	1/4-18	0.203	0.281	1.03	1.09	9/16
7755x6	3/8	1/4-18	0.281	0.281	1.05	1.09	9/16
7755x8	1/2	3/8-18	0.422	0.422	1.25	1.22	3/4
7755x8x8x8	1/2	1/2-14	0.422	0.531	1.35	1.47	7/8
7755x10	5/8	1/2-14	0.500	0.531	1.42	1.47	7/8
7755x12	3/4	3/4-14	0.656	0.719	1.58	1.59	1 1/16
7755x16	1	1-11 1/2	0.875	0.938	1.73	1.97	1 5/16

Note: All measurements are in inches.

Ermeto

Female run tee

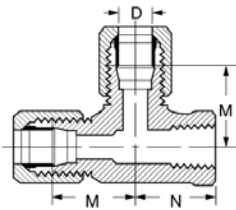
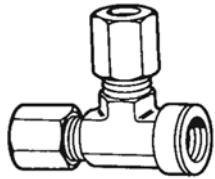
**7805x** (Ref SAE No. 080426)

Part number	Tube O.D.	Female pipe thread	D	M	N	Across flats
7805x4	1/4	1/8-27	0.203	0.89	0.66	9/16
7805x4x4x4	1/4	1/4-18	0.200	1.03	0.88	3/4
7805x6	3/8	1/4-18	0.281	1.05	0.88	3/4
7805x8	1/2	3/8-18	0.422	1.23	1.02	7/8
7805x10	5/8	1/2-14	0.500	1.42	1.23	1

Straight thread O-Ring run tee

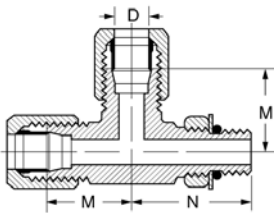
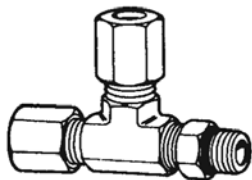
**7716x** (Ref. SAE No. 080428)

Part number	Tube O.D.	Port size	D	M	N	Across flats
7716x4	1/4	1/4	0.203	0.89	1.03	7/16
7716x6	3/8	3/8	0.281	1.05	1.25	9/16
7716x8	1/2	1/2	0.420	1.25	1.45	3/4

Note: All measurements are in inches.

Steel adapters

Ermeto

Ermeto

Male branch tee

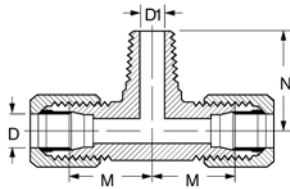
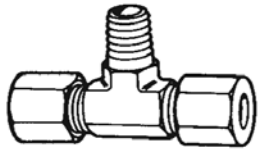

7605x (Ref. SAE No. 080425)

Part number	Tube O.D.	Male pipe thread	D	D1	M	N	Across flats
7605x4	1/4	1/8-27	0.203	0.188	0.89	0.78	7/16
7605x4x4x4	1/4	1/4-18	0.203	0.281	1.03	1.09	9/16
7605x6	3/8	1/4-18	0.281	0.281	1.05	1.09	9/16
7605x8	1/2	3/8-18	0.422	0.406	1.25	1.22	3/4
7605x8x8x8	1/2	1/2-14	0.422	0.531	1.35	1.47	7/8
7605x10	5/8	1/2-14	0.500	0.531	1.42	1.47	7/8
7605x12	3/4	3/4-14	0.656	0.719	1.58	1.59	1 1/16
7605x16	1	1-11 1/2	0.875	0.938	1.73	1.97	1 5/16

Female branch tee

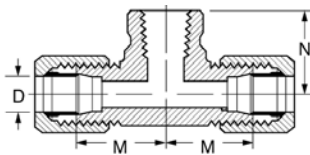
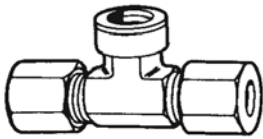

7655x (Ref. SAE No. 080427)

Part number	Tube O.D.	Female pipe thread	D	M	N	Across flats
7655x4	1/4	1/8-27	0.203	0.89	0.66	9/16
7655x4x4x4	1/4	1/4-18	0.203	1.03	0.88	3/4
7655x6	3/8	1/4-18	0.281	1.05	0.88	3/4
7655x8	1/2	3/8-18	0.422	1.23	1.02	7/8
7655x10	5/8	1/2-14	0.500	1.42	1.23	1 1/16
7655x12	3/4	3/4-14	0.656	1.58	1.36	1 5/16
7655x16	1	1-11 1/2	0.875	1.73	1.62	1 5/8

Note: All measurements are in inches.

Swivel joints



Swivel joints

Advantages of using Eaton Swivel Joints

1. Better System Plumbing:

- Less hose is needed when swivel joints are used, the system is more space efficient (Figure 1).
- Can eliminate the need for tubing configurations to accommodate 90° and other angles.
- Can be directly connected to hose lines frequently eliminating the need for adapters.

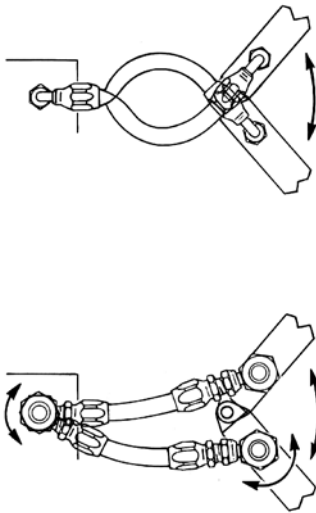

Figure 1

2. Prevent Hose Twisting and Kinking:

The swivel action swivel joints prevent hose twisting and kinking (Figure 2 & 3).

3. Less Downtime: The problem of hose twisting and kinking is eliminated and hose line replacement becomes significantly less.

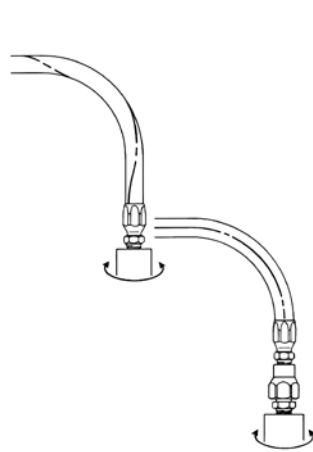

Figure 2

4. Absorb System Shock:

Swivel joints are not rigid and therefore capable of absorbing some hose shortening when the system is pressurized.

5. Cost Savings: Less hose, fewer adapters and tubing configurations and less downtime add up to saving money when swivel joints are used.

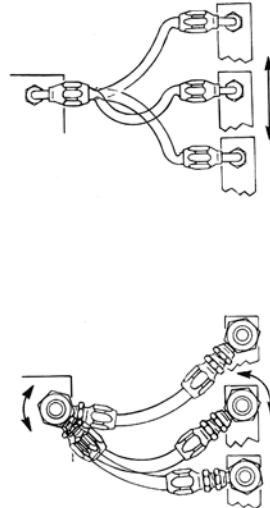

Figure 3

Features:

- Balanced-pressure design
- Low-drop dimensions
- Contamination seals
- 360° rotation
- Standard O-ring design

Benefits:

- Show no significant increase in torque with introduction of pressure
- Fit in compact areas
- Prevent environmental contaminants from entering the swivel joints
- Prevent hose twisting, thus increasing hose life
- Allow quick and reliable field repairs

FS65 Balanced-Pressure Series Swivel Joints answer customer requests for a more cost competitive, compact product.

FS65 Series Swivel Joints feature compact forged casings. Their balanced-pressure design distributes pressure evenly through the body of the joints, eliminating axial loading of the sleeve. This allows the swivel joints to rotate with very low torque—even up to their fully rated operating pressure.

The FS65 is available in sizes 1/4 - inch to 1 - inch. The swivel joints have pressure capabilities up to 5,000 PSI for the 1/4-inch and 3/8- inch sizes; 3,500 PSI for the 1/2-inch, 5/8-inch, and 3/4- inch sizes; and 3,000 PSI for the 1-inch size.

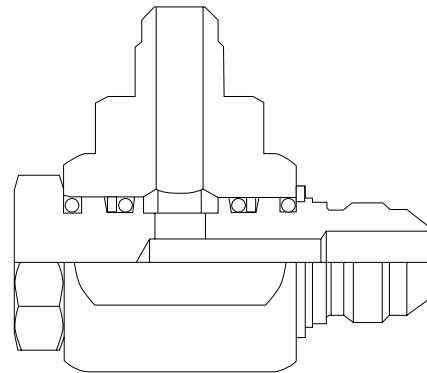

How to Order

When ordering a swivel joint, follow these steps:

1. State the base part number, casing and sleeve port size, as shown.

2. Add the suffix code which indicates the seal required, as shown in the seal chart at right.

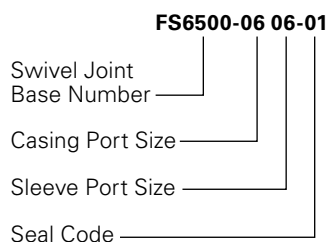

Seal Material Options

Seal Code	Material	Description	Application
-01	Buna-N	O-Ring Seal	Hydraulic Oils, Water, Glycol
-04	EPR	O-Ring Seal	Brake Fluids, Water, Phosphate Ester, Alcohols
-06	Flourocarbon	O-Ring Seal	Chemicals, Gasoline, Aromatic Solvents

Torque vs. Pressure

FS65 Series Swivel Joints perform best in class when it comes to side-load testing, while impulsing at 133 percent of maximum operating pressure—and rotating through a 120-degree angular sweep forward and in reverse.

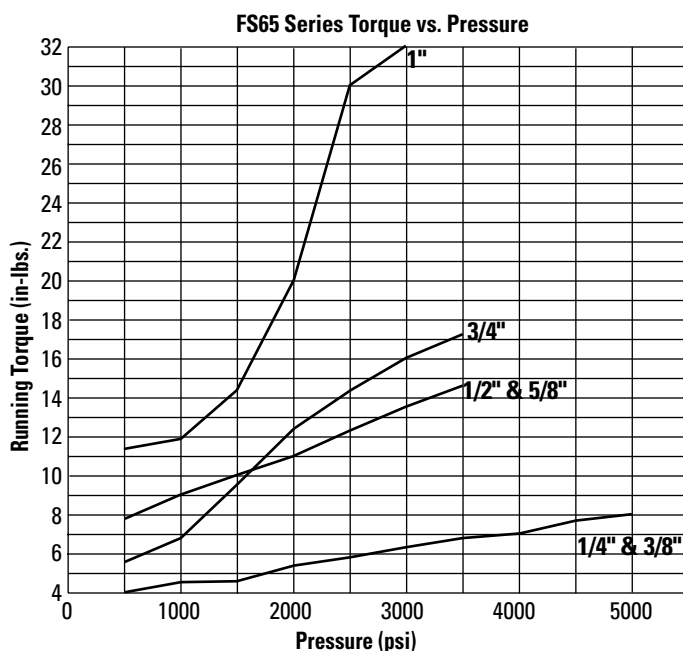

Pressure Drop vs Flow

FS65 Series Swivel Joints passed the minimum requirements of 150,000 cycles for the 1/4-inch and 3/8-inch nominal sizes, and 200,000 cycles for the 1/2-inch through 1-inch sizes, while measuring zero leakage per SAE J1176.

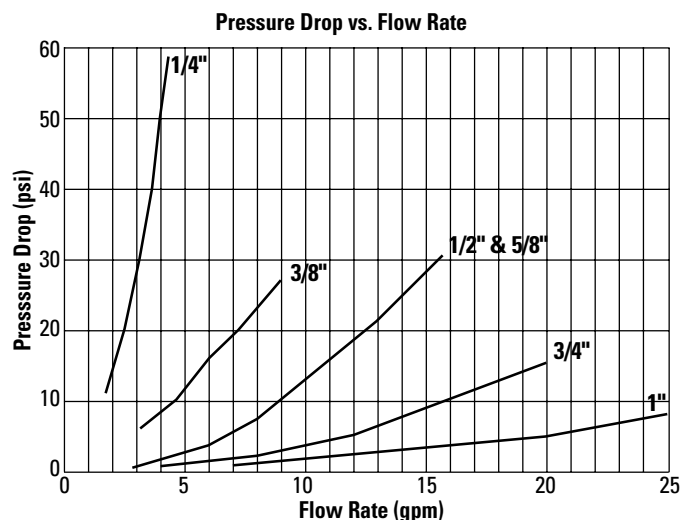

Pressure Rating for FS65 Series

SWIVEL SIZE	OPERATING PRESSURE (PSI)	SWIVEL SIZE	OPERATING PRESSURE (PSI)
1/4"	5000	5/8"	3500
3/8"	5000	3/4"	3500
1/2"	3500	1"	3000

Swivel joints

FS6500

Male Pipe x Female Pipe

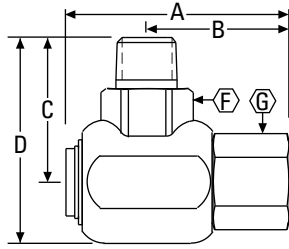

PART NUMBER	SWIVEL SIZE	CASING THREAD	SLEEVE THREAD	A	B	C	D	F	G
FS65015-0404-01	1/4	1/4-18 NPTF	1/4-18 NPTF	2.49	1.59	1.66	2.35	24 mm	15/16
FS65015-0808-01	3/8	1/2-14 NPTF	1/2-14 NPTF	3.14	1.97	1.62	2.39	29 mm	1-1/16
FS65015-1616-01	1	1-11 1/2 NPTF	1-11 1/2 NPTF	3.84	2.53	2.60	3.68	43 mm	1-5/8

Male Pipe x Male SAE 37°

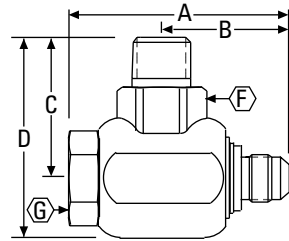

PART NUMBER	SWIVEL SIZE	CASING THREAD	SLEEVE THREAD	A	B	C	D	F	G
FS65019-1616-01	1	1-11 1/2 NPTF	1 5/16-12 UN-2A	3.86	2.23	2.60	3.68	43 mm	1-5/8

Male Pipe x Male SAE O-Ring Boss

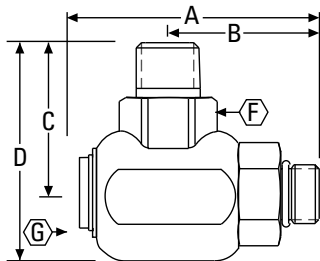

PART NUMBER	SWIVEL SIZE	CASING THREAD	SLEEVE THREAD	A	B	C	D	F	G
FS65022-1616-01	1	1-11 1/2 NPTF	1 5/16-12 UN-2A	3.67	2.35	2.60	3.68	43 mm	1-5/8

Female Pipe Swivel (NPSM) x Male Pipe

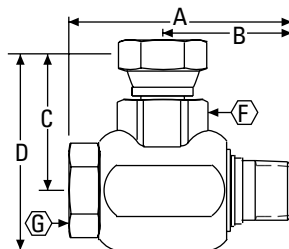

PART NUMBER	SWIVEL SIZE	CASING THREAD	SLEEVE THREAD	A	B	C	D	F	G
FS65000-0404-01	1/4	1/4-18 NPSM	1/4-18 NPTF	2.60	1.49	1.45	2.14	24 mm	15/16
FS65000-0606-01	3/8	3/8-18 NPSM	3/8-18 NPTF	2.53	1.48	1.45	2.14	24 mm	15/16
FS65000-0808-01	1/2	1/2-14 NPSM	1/2-14 NPTF	2.88	1.54	1.62	2.39	29 mm	1
FS65000-1212-01	3/4	3/4-14 NPSM	3/4-14 NPTF	3.21	1.89	2.14	3.09	34 mm	1-1/4
FS65000-1616-01	1	1-11 1/2 NPSM	1-11 1/2 NPTF	3.91	2.27	2.40	3.48	43 mm	1-5/8

*Special order only.

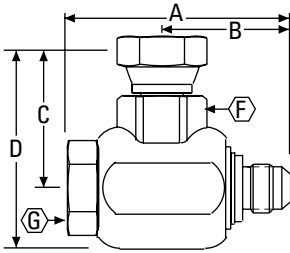
**Female Pipe Swivel (NPSM)
x Male SAE 37°**

PART NUMBER	SWIVEL SIZE	CASING THREAD	SLEEVE THREAD	A	B	C	D	F	G
FS65001-0404-01	1/4	1/4-18 NPSM	7/16-20 UNF-2A	2.58	1.46	1.45	2.14	24 mm	15/16
FS65001-0606-01	3/8	3/8-18 NPSM	9/16-18 UNF-2A	2.51	1.46	1.45	2.14	24 mm	15/16
FS65001-0608-01	3/8	3/8-18 NPSM	3/4-16 UNF-2A	2.61	1.56	1.45	2.14	24 mm	15/16
FS65001-0808-01	1/2	1/2-14 NPSM	3/4-16 UNF-2A	2.77	1.52	1.62	2.39	29 mm	1
FS65001-0810-01	1/2	1/2-14 NPSM	7/8-14 UNF-2A	2.88	1.62	1.62	2.39	29 mm	1
FS65001-1212-01	3/4	3/4-14 NPSM	1 1/16-12 UN-2A	3.31	1.99	2.14	3.09	34 mm	1-1/4
FS65001-1616-01	1	1-11 1/2 NPSM	1 5/16-12 UN-2A	3.86	2.23	2.40	3.48	43 mm	1-5/8

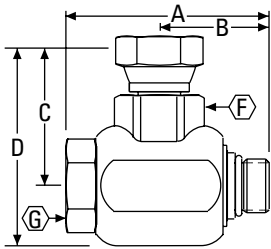
**Female Pipe Swivel (NPSM)
x Male SAE O-Ring Boss**

PART NUMBER	SWIVEL SIZE	CASING THREAD	SLEEVE THREAD	A	B	C	D	F	G
FS65002-0404-01	1/4	1/4-18 NPSM	7/16-20 UNF-2A	2.39	1.27	1.45	2.14	24 mm	15/16
FS65002-0405-01	1/4	1/4-18 NPSM	1/2-20UNF-2A	2.39	1.27	1.45	2.14	24 mm	15/16
FS65002-0606-01	3/8	3/8-18 NPSM	9/16-18UNF-2A	2.35	1.30	1.45	2.14	24 mm	15/16
FS65002-0608-01	3/8	3/8-18 NPSM	3/4-16UNF-2A	2.65	1.74	1.45	2.14	24 mm	15/16
FS65002-0808-01	1/2	1/2-14 NPSM	3/4-16UNF-2A	2.55	1.30	1.62	2.39	29 mm	1
FS65002-0810-01	1/2	1/2-14 NPSM	7/8-14UNF-2A	2.55	1.36	1.62	2.39	29 mm	1-1/16
FS65002-1212-01	3/4	3/4-14 NPSM	1 1/16-12 UN-2A	3.28	2.16	2.14	3.09	34 mm	1-1/4
FS65002-1616-01	1	1-11 1/2 NPSM	1 5/16-12 UN-2A	3.67	2.35	2.40	3.48	43 mm	1-5/8

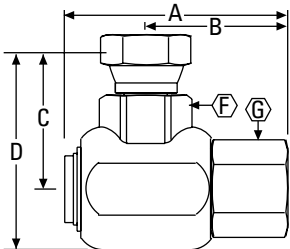
**Female Pipe Swivel
(NPSM) x Female Pipes**

PART NUMBER	SWIVEL SIZE	CASING THREAD	SLEEVE THREAD	A	B	C	D	F	G
FS65005-0404-01	1/4	1/4-18 NPSM	1/4-18 NPTF	2.49	1.59	1.45	2.14	24 mm	15/16
FS65005-0606-01	3/8	3/8-18 NPTF	3/8-18 NPTF	2.49	1.58	1.45	2.14	24 mm	15/16
FS65005-0808-01	1/2	1/2-14 NPTF	1/2-14 NPTF	3.14	1.97	1.62	2.39	29 mm	1-1/16
FS65005-1212-01	3/4	3/4-14 NPTF	3/4-14 NPTF	3.21	2.08	2.14	3.09	34 mm	1-5/16
FS65005-1616-01	1	1-11 1/2 NPTF	1-11 1/2 NPTF	3.84	2.53	2.40	3.48	43 mm	1-5/8

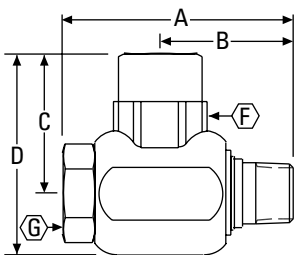
Female Pipe x Male Pipe

PART NUMBER	SWIVEL SIZE	CASING THREAD	SLEEVE THREAD	A	B	C	D	F	G
FS65007-0404-01	1/4	1/4-18 NPTF	1/4-18 NPTF	2.60	1.49	1.58	2.27	24 mm	15/16
FS65007-0606-01	3/8	3/8-18 NPTF	3/8-18 NPTF	2.53	1.48	1.59	2.28	24 mm	15/16
FS65007-0808-01	1/2	1/2-14 NPTF	1/2-14 NPTF	2.88	1.54	1.88	2.65	29 mm	1
FS65007-1212-01	3/4	3/4-14 NPTF	3/4-14 NPTF	3.21	1.89	2.30	3.25	34 mm	1-1/4
FS65007-1616-01	1	1-11 1/2 NPTF	1-11 1/2 NPTF	3.91	2.27	2.62	3.70	43 mm	1-5/8

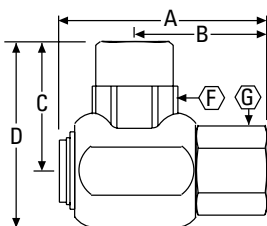
**Female Pipe x
Female Pipe**

PART NUMBER	SWIVEL SIZE	CASING THREAD	SLEEVE THREAD	A	B	C	D	F	G
FS65008-0404-01	1/4	1/4-18 NPTF	1/4-18 NPTF	2.49	1.59	1.58	2.27	24 mm	15/16
FS65008-0606-01	3/8	3/8-18 NPTF	3/8-18 NPTF	2.49	1.58	1.59	2.28	24 mm	15/16
FS65008-0808-01	1/2	1/2-14 NPTF	1/2-14 NPTF	3.14	1.97	1.88	2.65	29 mm	1-1/16
FS65008-1212-01	3/4	3/4-14 NPTF	3/4-14 NPTF	3.21	2.08	2.30	3.25	34 mm	1-5/16
FS65008-1616-01	1	1-11 1/2 NPTF	1-11 1/2 NPTF	3.84	2.53	2.62	3.70	43 mm	1-5/8

Swivel joints

FS6500

Female Pipe x Male SAE 37°

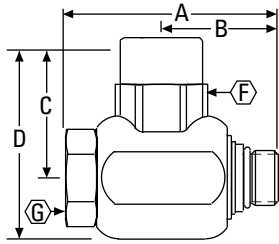

PART NUMBER	SWIVEL SIZE	CASING THREAD	SLEEVE THREAD	A	B	C	D	F	G
FS65010-0404-01	1/4	1/4-18 NPTF	7/16-20 UNF-2A	2.58	1.46	1.58	2.27	24 mm	15/16
FS65010-0808-01	1/2	1/2-14 NPTF	3/4-16 UNF-2A	2.77	1.52	1.88	2.65	29 mm	1
FS65010-1212-01	3/4	3/4-14 NPTF	1 1/16-12 UN-2A	3.31	1.99	2.30	3.25	34 mm	1-1/4
FS65010-1616-01	1	1-11 1/2 NPTF	1 5/16-12 UN-2A	3.86	2.23	2.62	3.70	43 mm	1-5/8

Female Pipe x Male SAE O-Ring Boss

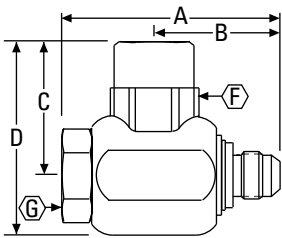

PART NUMBER	SWIVEL SIZE	CASING THREAD	SLEEVE THREAD	A	B	C	D	F	G
FS65011-0404-01	1/4	1/4-18 NPTF	7/16-20 UNF-2A	2.39	1.27	1.58	2.27	24 mm	15/16
FS65011-0606-01	3/8	3/8-18 NPTF	9/16-18 UNF-2A	2.35	1.30	1.59	2.28	24 mm	15/16
FS65011-0808-01	1/2	1/2-14 NPTF	3/4-16 UNF-2A	2.55	1.30	1.88	2.65	29 mm	1
FS65011-0810-01	1/2	1/2-14 NPTF	7/8-14 UNF-2A	2.88	1.36	1.88	2.65	29 mm	1-1/16
FS65011-1212-01	3/4	3/4-14 NPTF	1 1/16-12 UN-2A	3.28	2.16	2.30	3.25	34 mm	1-1/4
FS65011-1616-01	1	1-11 1/2 NPTF	1 5/16-12 UN-2A	3.67	2.35	2.62	3.70	43 mm	1-5/8

Male SAE 37° x Male Pipe

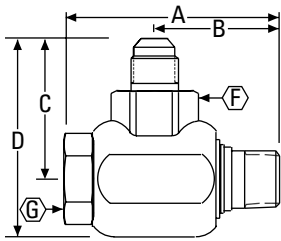

PART NUMBER	SWIVEL SIZE	CASING THREAD	SLEEVE THREAD	A	B	C	D	F	G
FS65003-0404-01	1/4	7/16-20 UNF-2A	1/4-18 NPTF	2.60	1.49	1.66	2.35	24 mm	15/16
FS65003-0504-01	1/4	1/2-20 UNF-2A	1/4-18 NPTF	2.60	1.49	1.66	2.35	24 mm	15/16
FS65003-0606-01	3/8	9/16-18 UNF-2A	9/16-18 NPTF	2.53	1.48	1.67	2.36	24 mm	15/16
FS65003-0806-01	3/8	3/4-16 UNF-2A	3/4-16 NPTF	2.53	1.58	1.77	2.46	24 mm	15/16
FS65003-0808-01	1/2	3/4-16 UNF-2A	1/2-14 NPTF	2.88	1.54	1.89	2.66	29 mm	1
FS65003-1008-01	1/2	7/8-14 UNF-2A	1/2-14 NPTF	2.88	1.54	2.00	2.77	29 mm	1
FS65003-1212-01	3/4	1 1/16-12 UN-2A	3/4-14 NPTF	3.21	1.89	2.36	3.31	34 mm	1-1/4
FS65003-1616-01	1	1 5/16-12 UN-2A	1-11 1/2 NPTF	3.91	2.27	2.60	3.68	43 mm	1-5/8

Male SAE 37°x Male SAE 37°

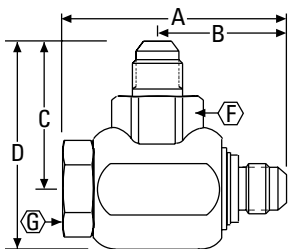

PART NUMBER	SWIVEL SIZE	CASING THREAD	SLEEVE THREAD	A	B	C	D	F	G
FS65004-0404-01	1/4	7/16-20 UNF-2A	7/16-20 UNF-2A	2.56	1.46	1.66	2.35	24 mm	15/16
FS65004-0505-01	1/4	1/2-20 UNF-2A	1/2-20 UNF-2A	2.56	1.46	1.66	2.35	24 mm	15/16
FS65004-0606-01	3/8	9/16-18 UNF-2A	9/16-18 UNF-2A	2.51	1.46	1.67	2.36	24 mm	15/16
FS65004-0808-01	3/8	3/4-16 UNF-2A	3/4-16 UNF-2A	2.61	1.56	1.77	2.46	24 mm	15/16
FS65004-1010-01	5/8	7/8-14 UNF-2A	7/8-14 UNF-2A	2.87	1.62	2.00	2.77	29 mm	1
FS65004-1212-01	3/4	1 1/16-12 UN-2A	1 1/16-12 UN-2A	3.31	1.99	2.36	3.31	34 mm	1-1/4
FS65004-1616-01	1	1 5/16-12 UN-2A	1 5/16-12 UN-2A	3.86	2.23	2.60	3.68	43 mm	1-5/8

Male SAE 37°x Male SAE O-Ring Boss

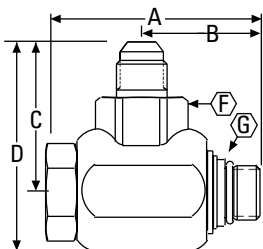

PART NUMBER	SWIVEL SIZE	CASING THREAD	SLEEVE THREAD	A	B	C	D	F	G
FS65009-0404-01	1/4	7/16-20 UNF-2A	7/16-20 UNF-2A	2.39	1.27	1.66	2.35	24 mm	15/16
FS65009-0505-01	1/4	1/2-20 UNF-2A	1/2-20 UNF-2A	2.39	1.27	1.66	2.35	24 mm	15/16
FS65009-0606-01	3/8	9/16-18 UNF-2A	9/16-18 UNF-2A	2.35	1.30	1.67	2.36	24 mm	15/16
FS65009-0808-01	3/8	3/4-16 UNF-2A	3/4-16 UNF-2A	2.65	1.74	1.77	2.46	24 mm	15/16
FS65009-1010-01	5/8	7/8-14 UNF-2A	7/8-14 UNF-2A	2.87	1.36	2.00	2.77	29 mm	1-1/16
FS65009-1212-01	3/4	1 1/16-12 UN-2A	1 1/16-12 UN-2A	3.28	2.16	2.36	3.31	34 mm	1-1/4
FS65009-1616-01	1	1 5/16-12 UN-2A	1 5/16-12 UN-2A	3.67	2.35	2.60	3.68	43 mm	1-5/8

Male SAE 37° x Female Pipe

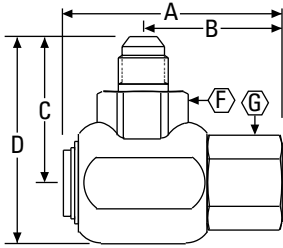

PART NUMBER	SWIVEL SIZE	CASING THREAD	SLEEVE THREAD	A	B	C	D	F	G
FS65016-1616-01	1	1 5/16-12 UN-2A	1-11 1/2 NPTF	3.84	2.53	2.60	3.68	43 mm	1-5/8

Male SAE O-Ring Boss x Male Pipe

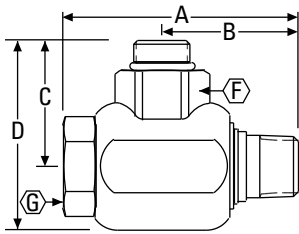

PART NUMBER	SWIVEL SIZE	CASING THREAD	SLEEVE THREAD	A	B	C	D	F	G
FS65013-1616-01	1	1 5/16-12 UN-2A	1-11 1/2 NPTF	3.91	2.27	2.37	3.45	43 mm	1-5/8

Male SAE O-Ring Boss x Female Pipe

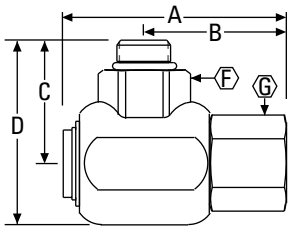

PART NUMBER	SWIVEL SIZE	CASING THREAD	SLEEVE THREAD	A	B	C	D	F	G
FS65017-1616-01	1	1 5/16-12 UN-2A	1-11 1/2 NPTF	3.84	2.53	2.37	3.45	43 mm	1-5/8

Male SAE O-Ring Boss x Male SAE 37°

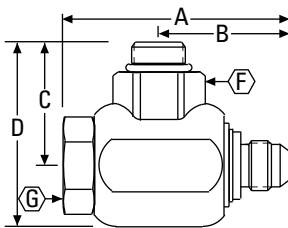

PART NUMBER	SWIVEL SIZE	CASING THREAD	SLEEVE THREAD	A	B	C	D	F	G
FS65020-1616-01	1	1 5/16-12 UN-2A	1 5/16-12 UN-2A	3.86	2.23	2.37	3.45	43 mm	1-5/8

Male SAE O-Ring Boss x Male SAE O-Ring Boss

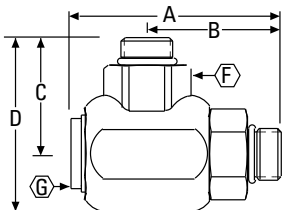

PART NUMBER	SWIVEL SIZE	CASING THREAD	SLEEVE THREAD	A	B	C	D	F	G
FS65023-1616-01	1	1 5/16-12 UN-2A	1 5/16-12 UN-2A	3.67	2.35	2.37	3.45	43 mm	1-5/8

Swivel joints

FS6500

Female SAE O-Ring Boss x Male Pipe

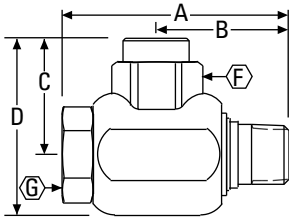

PART NUMBER	SWIVEL SIZE	CASING THREAD	SLEEVE THREAD	A	B	C	D	F	G
FS65014-1616-01	1	1 5/16-12 UN-2B	1-11 1/2 NPTF	3.91	2.27	2.32	3.40	43 mm	1-5/8

Female SAE O-Ring Boss x Female Pipe

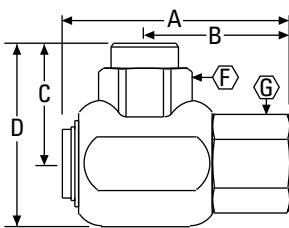

PART NUMBER	SWIVEL SIZE	CASING THREAD	SLEEVE THREAD	A	B	C	D	F	G
FS65018-1616-01	1	1 5/16-12 UN-2B	1-11 1/2 NPTF	3.84	2.53	2.32	3.40	43 mm	1-5/8

Female SAE O-Ring Boss x Male SAE 37°

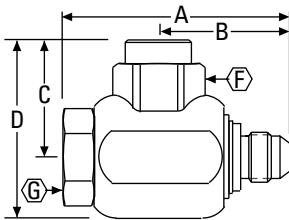

PART NUMBER	SWIVEL SIZE	CASING THREAD	SLEEVE THREAD	A	B	C	D	F	G
FS65021-1616-01	1	1 5/16-12 UN-2B	1 5/16-12 UN-2A	3.86	2.23	2.32	3.40	43 mm	1-5/8

Female SAE O-Ring Boss x Male SAE O-Ring Boss

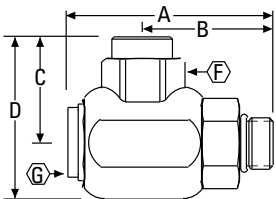

PART NUMBER	SWIVEL SIZE	CASING THREAD	SLEEVE THREAD	A	B	C	D	F	G
FS65024-1616-01	1	1 5/16-12 UN-2B	1 5/16-12 UN-2A	3.67	2.35	2.32	3.40	43 mm	1-5/8

Male ORS x Male O-Ring Boss

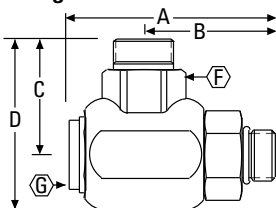

PART NUMBER	SWIVEL SIZE	CASING THREAD	SLEEVE THREAD	A	B	C	D	F	G
FS65025-1212-01	3/4	1 3/16-12 UN-2A	1 1/16-12 UN-2A	3.28	2.16	2.25	3.20	34 mm	1-1/4
FS65025-1616-01	1	1 7/16-12 UN-2A	1 5/16-12 UN-2A	3.67	2.35	2.55	3.63	43 mm	1-5/8

The FS5900 Series Swivel Joint is designed for 25 in./Hg vacuum to 5000 psi operating pressure service made possible by advanced design needle bearings and seals. In addition to high pressures, the FS5900 series provides full fluid flow with minimal pressure drop.

The excellent corrosion resistance of the FS5900 series is made possible by the plated steel components.

Both field and laboratory testing have proven the FS5900 Series Swivel Joints can withstand greater side loads than conventional swivel joints. High pressure impulse life has also been improved.

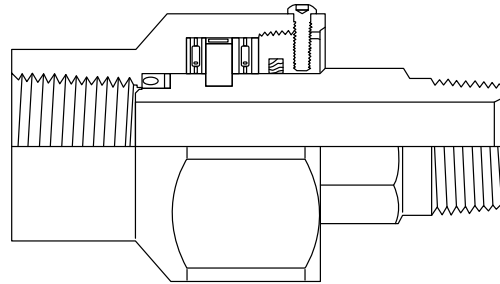

Torque vs Pressure

Testing to determine the torque required to rotate an FS5900 Series Swivel Joint was conducted on actual production assemblies.

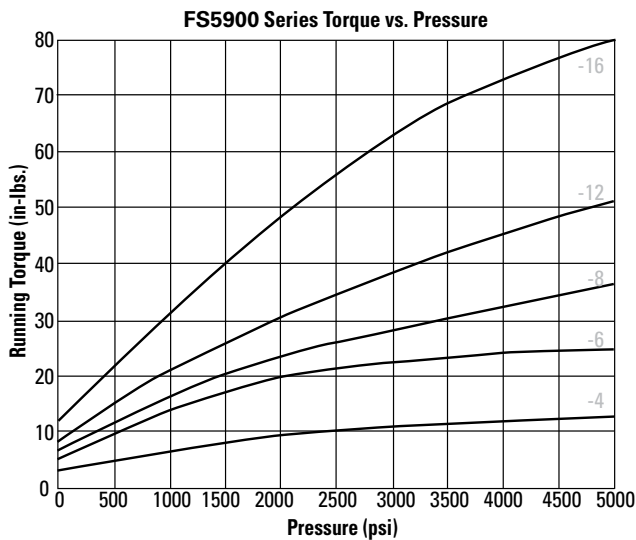

Pressure Drop vs Flow

Testing for pressure drop at various flow rates was conducted with MIL-H-5606 hydraulic oil at temperatures (+70°F to +80°F).

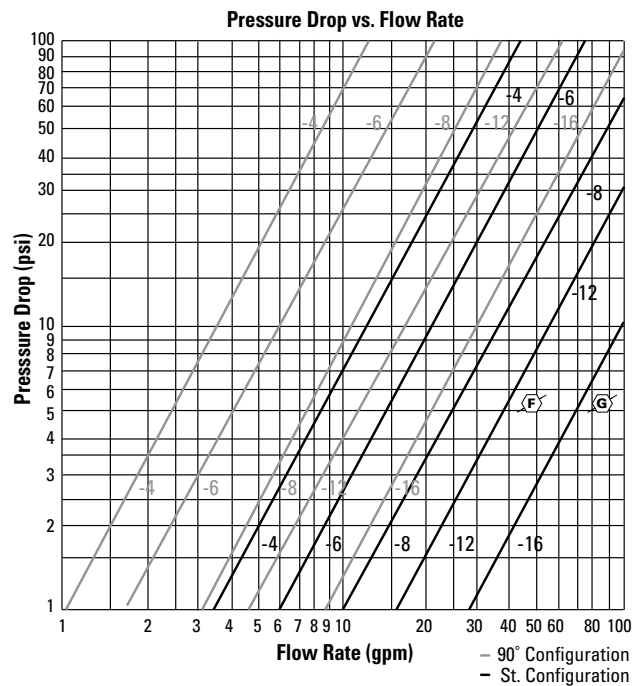

Seal Options:

O-Ring Seals (1/4 inch size only)

Suffix Number	Material	Temp Range	Standard	Optional
-01	Buna-N	-40°F to 250°F	X	
-04	EPR	-60°F to 300°F		X
-06	Flourocarbon	-20°F to 300°F		X

U-Cup Seals (3/8" through 1" sizes)

Suffix Number	Material	Temp Range	Standard	Optional
-75	Hytrel/Buna	-20°F to 250°F	X	
-74	Urethane/Buna	-40°F to 180°F		X

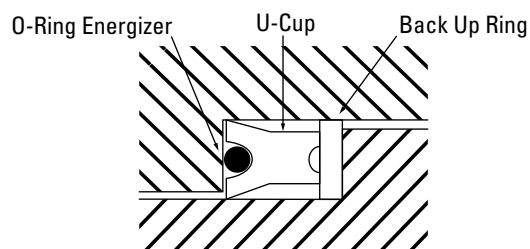
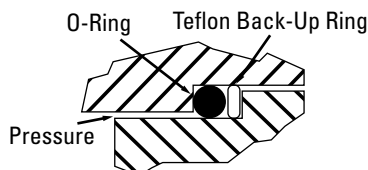

Swivel joints

FS5900

(Straight) Female Pipe to Female Pipe

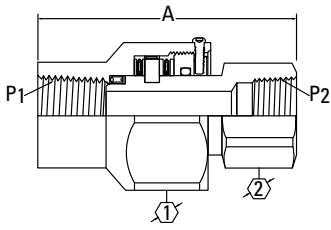

PART NUMBER	NOM. SIZE	THREAD P1	THREAD P2	A	B	C	①	②
FS59001-1616-75	1"	1-111/2 NPTF	1-111/2 NPTF	4.31			2.50	1.62

Female Pipe to Male Pipe

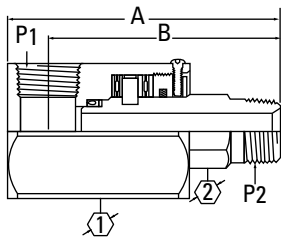

PART NUMBER	NOM. SIZE	THREAD P1	THREAD P2	A	B	C	①	②
FS59002-0404-01	1/4"	1/4-18 NPTF	1/4-18 NPTF	3.20	2.82		1.19	.56
FS59002-0606-75	3/8"	3/8-18 NPTF	3/8-18 NPTF	3.67	3.21		1.88	.94
FS59002-0808-75	1/2"	1/2-14 NPTF	1/2-14 NPTF	4.01	3.45		1.88	.94
FS59002-1212-75	3/4"	3/4-14 NPTF	3/4-14 NPTF	4.32	3.64		2.12	1.19
FS59002-1616-75	1"	1-111/2 NPTF	1-111/2 NPTF	4.88	4.08		2.50	1.44

Female Pipe to Male SAE 37°

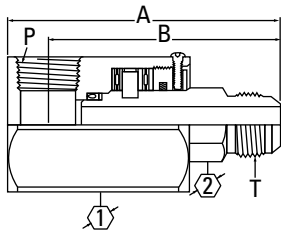

PART NUMBER	NOM. SIZE	THREAD P1	THREAD P2	A	B	C	①	②
FS59003-0405-01	1/4"	1/4-18 NPTF	1/2-20 UNF-2A	3.19	2.81		1.19	.56
FS59003-0608-75	3/8"	3/8-18 NPTF	3/4-16 UNF-2A	3.77	3.31		1.88	.94
FS59003-0810-75	1/2"	1/2-14 NPTF	7/8-14 UNF-2A	4.00	3.44		1.88	.94
FS59003-1212-75	3/4"	3/4-14 NPTF	11/16-12 UN-2A	4.43	3.75		2.12	1.19
FS59003-1616-75	1"	1-111/2 NPTF	15/16-12 UN-2A	4.85	4.05		2.50	1.44

Female Pipe to Male Pipe

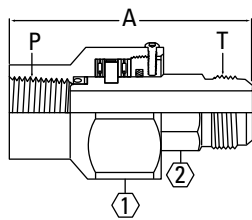

PART NUMBER	NOM. SIZE	THREAD P1	THREAD P2	A	B	C	①	②
FS59004-0404-01	1/4"	1/4-18 NPTF	1/4-18 NPTF	3.23			1.19	.56
FS59004-0606-75	3/8"	3/8-18 NPTF	3/8-18 NPTF	3.62			1.88	.94
FS59004-0808-75	1/2"	1/2-14 NPTF	1/2-14 NPTF	3.97			1.88	.94
FS59004-1212-75	3/4"	3/4-14 NPTF	3/4-14 NPTF	4.04			2.12	1.19
FS59004-1616-75	1"	1-111/2 NPTF	1-111/2 NPTF	4.57			2.50	1.44

Female Pipe to Male SAE 37°

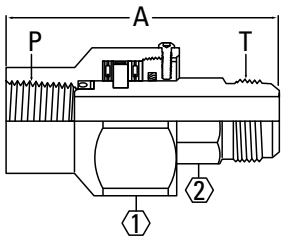

PART NUMBER	NOM. SIZE	THREAD P1	THREAD P2	A	B	①	②
FS59005-0405-01	1/4"	1/4-18 NPTF	1/2-20 UNF-2A	3.22		1.19	.56
FS59005-0608-75	3/8"	3/8-18 NPTF	3/4-16 UNF-2A	3.72		1.88	.94
FS59005-0810-75	1/2"	1/2-14 NPTF	7/8-14 UNF-2A	3.96		1.88	.94
FS59005-1212-75	3/4"	3/4-14 NPTF	1-1/16-12 UN-2A	4.15		2.12	1.19
FS59005-1616-75	1"	1-11-1/2 NPTF	1-5/16-12 UN-2A	4.54		2.50	1.44

Male SAE 37° to Female SAE 37°

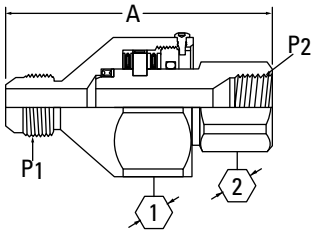

PART NUMBER	NOM. SIZE	THREAD P1	THREAD P2	A	B	①	②
FS59006-0505-01	1/4"	1/2-20 UNF-2A	1/2-20 UNF-2B	2.98		1.19	.62
FS59006-0808-75	3/8"	3/4-16 UNF-2A	3/4-16 UNF-2B	3.48		1.88	.94
FS59006-1010-75	1/2"	7/8-14 UNF-2A	7/8-14 UNF-2B	3.74		1.88	1.00
FS59006-1212-75	3/4"	1-1/16-12 UN-2A	1-1/16-12 UN-2B	3.88		2.12	1.25
FS59006-1616-75	1"	1-5/16-12 UN-2A	1-5/16-12 UN-2B	4.03		2.50	1.50

Male SAE 37° to Female SAE 37°

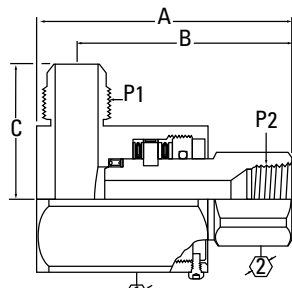

PART NUMBER	NOM. SIZE	THREAD P1	THREAD P2	A	B	C	①	②
FS59011-0505-01	1/4"	1/2-20 UNF-2A	1/2-20 UNF-2B	2.69	2.41	1.16	1.19	.62
FS59011-0808-75	3/8"	3/4-16 UNF-2A	3/4-16 UNF-2B	3.08	2.73	1.59	1.88	.94
FS59011-1010-75	1/2"	7/8-14 UNF-2A	7/8-14 UNF-2B	3.46	3.06	1.70	1.88	1.00
FS59011-1212-75	3/4"	1-1/16-12 UN-2A	1-1/16-12 UN-2B	3.58	3.08	1.93	2.12	1.25
FS59011-1616-75	1"	1-5/16-12 UN-2A	1-5/16-12 UN-2B	3.91	3.29	2.16	2.50	1.50

FS5900 Repair Kits

The FS5900 Series Swivel Joints are easily field repaired. Two different kits are available. The choice of which kit to use is dependent upon the extent of repairs necessary.

FF974 Kits include: a replacement seal assembly, back-up rings and a new dust seal.

FF975 Kits include: a replacement seal assembly, back-up rings, a new dust seal and two sets of bearings and races.

To order FF974 and FF975 Kits: FF974- 08- 75

Kit Base Number _____

Joint Size _____
(Swivel Joint Nominal size 1/2")

Seal Material Code _____

NOTE: Use swivel joint nominal size when ordering kits, not port size.



Cross reference index





Part number catalog cross referencing index

Former WH Part Number	Eaton Part Number	Catalog Page
C5105X10	1290-10S	127
C5105X12	1290-12S	127
C5105X14	1290-14S	127
C5105X16	1290-16S	127
C5105X20	1290-20S	127
C5105X24	1290-24S	127
C5105X2	1290-2S	127
C5105X32	1290-32S	127
C5105X3	1290-3S	127
C5105X4	1290-4S	127
C5105X5	1290-5S	127
C5105X6	1290-6S	127
C5105X8	1290-8S	127
MC5206X8X10	15.063-10-8	131
MC5206X8X12	15.063-12-8	131
MC5206X10X15	15.063-15-10	131
MC5206X12X18	15.063-18-12	131
MC5206X4X6	15.063-6-4	131
MC5206X6X8	15.063-8-6	131
MC5207X8X12	15.117-10-8	131
MC5207X12X18	15.117-16-12	131
MC5207x20x28	15.117-25-20	131
MC5207X4X6	15.117-4-4	131
MC5207X6X8	15.117-6-6	131
MC5207X6X10	15.117-8-6	131
MC5207X8X10	15.117-8-8	131
MC5208X8X10	15.147-10-8	131
MC5208X10X14	15.147-14-10	131
MC5208X12X16	15.147-16-12	131
MC5208X16X20	15.147-20-16	131
MC5208X6X6	15.147-6-6	131
C9240	2004-12-16S	128
C9200	2004-16-16S	128
9100X12X12	2018-12-12S	79
9100X16X12	2018-12-16S	79
9100X16X16	2018-16-16S	79
9100X4X2	2018-2-4S	79
9100X20X20	2018-20-20S	79
9100X4X4	2018-4-4S	79
9100X5X4	2018-4-5S	79
9100X6X4	2018-4-6S	79
9100X10X6	2018-6-10S	79
9100X6X6	2018-6-6S	79
9100X8X6	2018-6-8S	79
9100X10X8	2018-8-10S	79
9100X12X8	2018-8-12S	79
9100X8X8	2018-8-8S	79
C5955X12	2020-12-12S	102
C5955X16	2020-16-16S	102
C5955X4	2020-4-4S	102
C5955X6	2020-6-6S	102
C5955X8	2020-8-8S	102
C5205X10X12	2021-12-10S	77
C5205X12	2021-12-12S	77
C5205X14	2021-12-14S	77
C5205x16X12	2021-12-16S	77
C5205X6X12	2021-12-6S	77
C5205X8X12	2021-12-8S	77
C5205X12X16	2021-16-12S	77
C5205X16	2021-16-16S	77
C5205X20X16	2021-16-20S	77
C5205X24X16	2021-16-24S	77
C5205X2	2021-2-2S	77
C5205X3	2021-2-3S	77
C5205X4	2021-2-4S	77
C5205X5	2021-2-5S	77
C5205X6X2	2021-2-6S	77
C5205X8X2	2021-2-8S	77
C5205X12X20	2021-20-12S	77
C5205X16X20	2021-20-16S	77
C5205X20	2021-20-20S	77
C5205X24X20	2021-20-24S	77
C5205X12X24	2021-24-12S	77
C5205X16X24	2021-24-16S	77
C5205X20X24	2021-24-20S	77
C5205X24	2021-24-24S	77
C5205X32X24	2021-24-32S	77
C5205X32	2021-32-32S	77

Former WH Part Number	Eaton Part Number	Catalog Page
C5205X4X4	2021-4-4S	77
C5205X5X4	2021-4-5S	77
C5205X6	2021-4-6S	77
C5205X8X4	2021-4-8S	77
C5205X10X6	2021-6-10S	77
C5205X4X6	2021-6-4S	77
C5205X5X6	2021-6-5S	77
C5205X6X6	2021-6-6S	77
C5205X8	2021-6-8S	77
C5205X10	2021-8-10S	77
C5205X12X8	2021-8-12S	77
C5205X4X8	2021-8-4S	77
C5205X6X8	2021-8-6S	77
C5205X8X8	2021-8-8S	77
C5880X3	202124-3-3S	128
C5880X4X3	202124-3-4S	128
C5880X4	202124-4-4S	128
C5880X5	202124-5-5S	128
C5880X6	202124-6-6S	128
C5880X8	202124-8-8S	128
C5255X10X12	2022-12-10S	80
C5255X12	2022-12-12S	80
C5255X16X12	2022-12-16S	80
C5255X8X12	2022-12-8S	80
C5255X12X16	2022-16-12S	80
C5255X16	2022-16-16S	80
C5255X2	2022-2-2S	80
C5255X3	2022-2-3S	80
C5255X4	2022-2-4S	80
C5255X5	2022-2-5S	80
C5255X16X20	2022-20-16S	80
C5255X20	2022-20-20S	80
C5255X24	2022-24-24S	80
C5255X32	2022-32-32S	80
C5255X3X4	2022-4-3S	80
C5255X4X4	2022-4-4S	80
C5255X5X4	2022-4-5S	80
C5255X6	2022-4-6S	80
C5255X8X4	2022-4-8S	80
C5255X10X6	2022-6-10S	80
C5255X6X6	2022-6-6S	80
C5255X8	2022-6-8S	80
C5255X10	2022-8-10S	80
C5255X12X8	2022-8-12S	80
C5255X6X8	2022-8-6S	80
C5255X8X8	2022-8-8S	80
C5355X10X12	2023-12-10S	81
C5355X12	2023-12-12S	81
C5355X16X12	2023-12-16S	81
C5355X8X12	2023-12-8S	81
C5355X12X16	2023-16-12S	81
C5355X16	2023-16-16S	81
C5355X20X16	2023-16-20S	81
C5355X3	2023-2-3S	81
C5355X4	2023-2-4S	81
C5355X5	2023-2-5S	81
C5355X6X2	2023-2-6S	81
C5355X24	2023-24-24S	81
C5355X32	2023-32-32S	81
C5355X4X4	2023-4-4S	81
C5355X5X4	2023-4-5S	81
C5355X6	2023-4-6S	81
C5355X8X4	2023-4-8S	81
C5355X10X6	2023-6-10S	81
C5355X4X6	2023-6-4S	81
C5355X6X6	2023-6-6S	81
C5355X8	2023-6-8S	81
C5355X10	2023-8-10S	81
C5355X12X8	2023-8-12S	81
C5355X6X8	2023-8-6S	81
C5355X8X8	2023-8-8S	81
C5405X10X12	2024-12-10S	82
C5405X12	2024-12-12S	82
C5405X16X12	2024-12-16S	82
C5405X6X12	2024-12-6S	82
C5405X8X12	2024-12-8S	82
C5405X12X16	2024-16-12S	82
C5405X16	2024-16-16S	82

Part number catalog cross referencing index

Former WH Part Number	Eaton Part Number	Catalog Page
C5405X20X16	2024-16-20S	82
C5405X3	2024-2-3S	82
C5405X4	2024-2-4S	82
C5405X5	2024-2-5S	82
C5405X6X2	2024-2-6S	82
C5405X16X20	2024-20-16S	82
C5405X20	2024-20-20S	82
C5405X24X20	2024-20-24S	82
C5405X20X24	2024-24-20S	82
C5405X24	2024-24-24S	82
C5405X32X24	2024-24-32S	82
C5405X32	2024-32-32S	82
C5405X4X4	2024-4-4S	82
C5405X5X4	2024-4-5S	82
C5405X6	2024-4-6S	82
C5405X8X4	2024-4-8S	82
C5405X10X6	2024-6-10S	82
C5405X12X6	2024-6-12S	82
C5405X4X6	2024-6-4S	82
C5405X5X6	2024-6-5S	82
C5405X6X6	2024-6-6S	82
C5405X8	2024-6-8S	82
C5405X10	2024-8-10S	82
C5405X12X8	2024-8-12S	82
C5405X16X8	2024-8-16S	82
C5405X4X8	2024-8-4S	82
C5405X6X8	2024-8-6S	82
C5405X8X8	2024-8-8S	82
C5425X12	202411-12-12S	83
C5425X16X12	202411-12-16S	83
C5425X16	202411-16-16S	83
C5425X4	202411-2-4S	83
C5425X20	202411-20-20S	83
C5425X4X4	202411-4-4S	83
C5425X6	202411-4-6S	83
C5425X6X6	202411-6-6S	83
C5425X8	202411-6-8S	83
C5425X10	202411-8-10S	83
C5425X8X8	202411-8-8S	83
C5435X12	202413-12-12S	83
C5435X16X12	202413-12-16S	83
C5435X16	202413-16-16S	83
C5435X4	202413-2-4S	83
C5435X20	202413-20-20S	83
C5435X4X4	202413-4-4S	83
C5435X5X4	202413-4-5S	83
C5435X6	202413-4-6S	83
C5435X6X6	202413-6-6S	83
C5435X8	202413-6-8S	83
C5435X10	202413-8-10S	83
C5435X12X8	202413-8-12S	83
C5435X8X8	202413-8-8S	83
C5455X12	2025-12-12S	85
C5455X16	2025-16-16S	85
C5455X4	2025-2-4S	85
C5455X5	2025-2-5S	85
C5455X6X2	2025-2-6S	85
C5455X20	2025-20-20S	85
C5455X24	2025-24-24S	85
C5455X4X4	2025-4-4S	85
C5455X5X4	2025-4-5S	85
C5455X6	2025-4-6S	85
C5455X8X4	2025-4-8S	85
C5455X4X6	2025-6-4S	85
C5455X6X6	2025-6-6S	85
C5455X8	2025-6-8S	85
C5455X10	2025-8-10S	85
C5455X12X8	2025-8-12S	85
C5455X8X8	2025-8-8S	85
C5305X10	2027-10-10S	94
C5305X10X8	2027-10-8S	94
C5305X12X10	2027-12-10S	94
C5305X12	2027-12-12S	94
C5305X12X8	2027-12-8S	94
C5305X14	2027-14-14S	94
C5305X16X12	2027-16-12S	94
C5305X16	2027-16-16S	94
C5305X2	2027-2-2S	94

Former WH Part Number	Eaton Part Number	Catalog Page
C5305X20	2027-20-20S	94
C5305X24	2027-24-24S	94
C5305X3	2027-3-3S	94
C5305X32	2027-32-32S	94
C5305X4	2027-4-4S	94
C5305X5X4	2027-5-4S	94
C5305X5	2027-5-5S	94
C5305X6X4	2027-6-4S	94
C5305X6X5	2027-6-5S	94
C5305X6	2027-6-6S	94
C5305X8X4	2027-8-4S	94
C5305X8X6	2027-8-6S	94
C5305X8	2027-8-8S	94
C5315X10	202702-10-10S	104
C5315X12X10	202702-10-12S	104
C5315X16X10	202702-10-16S	104
C5315X4X10	202702-10-4S	104
C5315X6X10	202702-10-6S	104
C5315X8X10	202702-10-8S	104
C5315X10X12	202702-12-10S	104
C5315X12	202702-12-12S	104
C5315X16X12	202702-12-16S	104
C5315X8X12	202702-12-8S	104
C5315X12X14	202702-14-12S	104
C5315X14	202702-14-14S	104
C5315X10X16	202702-16-10S	104
C5315X12X16	202702-16-12S	104
C5315X16	202702-16-16S	104
C5315X20X16	202702-16-20S	104
C5315X8X16	202702-16-8S	104
C5315X2	202702-2-2S	104
C5315X12X20	202702-20-12S	104
C5315X16X20	202702-20-16S	104
C5315X20	202702-20-20S	104
C5315X24X20	202702-20-24S	104
C5315X16X24	202702-24-16S	104
C5315X20X24	202702-24-20S	104
C5315X24	202702-24-24S	104
C5315X32X24	202702-24-32S	104
C5315X3	202702-3-3S	104
C5315X32	202702-32-32S	104
C5315X4	202702-4-4S	104
C5315X5X4	202702-4-5S	104
C5315X6X4	202702-4-6S	104
C5315X4X5	202702-5-4S	104
C5315X5	202702-5-5S	104
C5315X6X5	202702-5-6S	104
C5315X4X6	202702-6-4S	104
C5315X5X6	202702-6-5S	104
C5315X6	202702-6-6S	104
C5315X8X6	202702-6-8S	104
C5315X10X8	202702-8-10S	104
C5315X12X8	202702-8-12S	104
C5315X4X8	202702-8-4S	104
C5315X6X8	202702-8-6S	104
C5315X8	202702-8-8S	104
C5306X10	202712-10-10S	95
C5306X12	202712-12-12S	95
C5306X16	202712-16-16S	95
C5306X20	202712-20-20S	95
C5306X4	202712-4-4S	95
C5306X6	202712-6-6S	95
C5306X8	202712-8-8S	95
C5316X10	202713-10-10S	105
C5316X12	202713-12-12S	105
C5316X16	202713-16-16S	105
C5316X4	202713-4-4S	105
C5316X6	202713-6-6S	105
C5316X8X6	202713-6-8S	105
C5316X8	202713-8-8S	105
C5755X10X12X10	2028-12-10S	86
C5755X12	2028-12-12S	86
C5755X16	2028-16-16S	86
C5755X4	2028-2-4S	86
C5755X20	2028-20-20S	86
C5755X4X4X4	2028-4-4S	86
C5755X5X4X5	2028-4-5S	86
C5755X6	2028-4-6S	86

Part number catalog cross referencing index

Former WH Part Number	Eaton Part Number	Catalog Page
C5755X6X6X6	2028-6-6S	86
C5755X8	2028-6-8S	86
C5755X10	2028-8-10S	86
C5755X8X8X8	2028-8-8S	86
C5805X12	2029-12-12S	88
C5805X16	2029-16-16S	88
C5805X4	2029-2-4S	88
C5805X6	2029-4-6S	88
C5605X12	2030-12-12S	87
C5605X16	2030-16-16S	87
C5605X4	2030-2-4S	87
C5605X5	2030-2-5S	87
C5605X4X4X4	2030-4-4S	87
C5605X6	2030-4-6S	87
C5605X6X6X6	2030-6-6S	87
C5605X8	2030-6-8S	87
C5605X10	2030-8-10S	87
C5605X8X8X8	2030-8-8S	87
C5725X10	203002-1-10-10S	100
C5725X12	203002-1-12-12S	100
C5725X16	203002-1-16-16S	100
C5725X4	203002-1-4-4S	100
C5725X6	203002-1-6-6S	100
C5725X8	203002-1-8-8S	100
C5715X10	203003-10-10S	108
C5715X12	203003-12-12S	108
C5715X16	203003-16-16S	108
C5715X20	203003-20-20S	108
C5715X4	203003-4-4S	108
C5715X6	203003-6-6S	108
C5715X8	203003-8-8S	108
C5716X10	203005-10-10S	108
C5716X12	203005-12-12S	108
C5716X16	203005-16-16S	108
C5716X20	203005-20-20S	108
C5716X4	203005-4-4S	108
C5716X5	203005-5-5S	108
C5716X6	203005-6-6S	108
C5716X8	203005-8-8S	108
C5655X12	2031-12-12S	88
C5655X16	2031-16-16S	88
C5655X4	2031-2-4S	88
C5655X32	2031-32-32S	88
C5655X4X4X4	2031-4-4S	88
C5655X6	2031-4-6S	88
C5655X8	2031-6-8S	88
C5655X10	2031-8-10S	88
C5655X8X8X8	2031-8-8S	88
C5707X10	203101-10-10S	101
C5707X12	203101-12-12S	101
C5707X16	203101-16-16S	101
C5707X20	203101-20-20S	101
C5707X4	203101-4-4S	101
C5707X6	203101-6-6S	101
C5707X8	203101-8-8S	101
C5706X10	203102-10-10S	101
C5706X12	203102-12-12S	101
C5706X16	203102-16-16S	101
C5706X20	203102-20-20S	101
C5706X4	203102-4-4S	101
C5706X5	203102-5-5S	101
C5706X6	203102-6-6S	101
C5706X8	203102-8-8S	101
C5705X10	2033-10-10S	100
C5705X12	2033-12-12S	100
C5705X16	2033-16-16S	100
C5705X20	2033-20-20S	100
C5705X24	2033-24-24S	100
C5705X4	2033-4-4S	100
C5705X5	2033-5-5S	100
C5705X6	2033-6-6S	100
C5705X8	2033-8-8S	100
C5505X10	2039-10-10S	98
C5505X12	2039-12-12S	98
C5505X16	2039-16-16S	98
C5505X20	2039-20-20S	98
C5505X24	2039-24-24S	98

Former WH Part Number	Eaton Part Number	Catalog Page
C5505X4	2039-4-4S	98
C5505X5	2039-5-5S	98
C5505X6	2039-6-6S	98
C5505X8	2039-8-8S	98
C3209X16X12	2040-12-16S	65
C3209X20X16	2040-16-20S	65
C3209X4X2	2040-2-4S	65
C3209X8X2	2040-2-8S	65
C3209X24X20	2040-20-24S	65
C3209X32X24	2040-24-32s	65
C3209X12X4	2040-4-12S	65
C3209X6X4	2040-4-6S	65
C3209X8X4	2040-4-8S	65
C3209X8X6	2040-6-8S	65
C3209X12X8	2040-8-12S	65
C3209X16X8	2040-8-16S	65
C5325X10	2041-1-10-10S	95
C5325X12	2041-1-12-12S	95
C5325X16	2041-1-16-16S	95
C5325X20	2041-1-20-20S	95
C5325X3	2041-1-3-3S	95
C5325X4	2041-1-4-4S	95
C5325X5	2041-1-5-5S	95
C5325X6	2041-1-6-6S	95
C5325X8	2041-1-8-8S	95
C5325X12BN	2041-12-12S	95
C5325X20BN	2041-20-20S	95
C5325X3BN	2041-3-3S	95
C5325X4BN	2041-4-4S	95
C5325X5BN	2041-5-5S	95
C5325X6BN	2041-6-6S	95
C5325X8BN	2041-8-8S	95
C5375X10	2042-1-10-10S	97
C5375X12	2042-1-12-12S	97
C5375X4	2042-1-4-4S	97
C5375X5	2042-1-5-5S	97
C5375X6	2042-1-6-6S	97
C5375X8	2042-1-8-8S	97
C5525X10	2043-1-10-10S	98
C5525X12	2043-1-12-12S	98
C5525X16	2043-1-16-16S	98
C5525X4	2043-1-4-4S	98
C5525X5	2043-1-5-5S	98
C5525X6	2043-1-6-6S	98
C5525X8	2043-1-8-8S	98
9205X12X12	2045-12-12S	66
9205X12X16	2045-12-16S	66
9205X12X8	2045-12-8S	66
9205X16X12	2045-16-12S	66
9205X16X16	2045-16-16S	66
9205X16X20	2045-16-20S	66
9205X2X2	2045-2-2S	66
9205X2X4	2045-2-4S	66
9205X20X16	2045-20-16S	66
9205X20X20	2045-20-20S	66
9205X20X24	2045-20-24S	66
9205x24x20	2045-24-20S	66
9205X24X24	2045-24-24S	66
9205X32X32	2045-32-32S	66
9205X4X2	2045-4-2S	66
9205X4X4	2045-4-4S	66
9205X4X6	2045-4-6S	66
9205X4X8	2045-4-8S	66
9205X6X4	2045-6-4S	66
9205X6X6	2045-6-6S	66
9205X6X8	2045-6-8S	66
9205X8X12	2045-8-12S	66
9205X8X6	2045-8-6S	66
9205X8X8	2045-8-8S	66
9255X12X12	2046-12-12S	66
9255X12X16	2046-12-16S	66
9255X16X16	2046-16-16S	66
9255X2X2	2046-2-2S	66
9255X2X4	2046-2-4S	66
9255X20X20	2046-20-20S	66
9255X24X24	2046-24-24S	66
9255X32X32	2046-32-32S	66
9255X4X4	2046-4-4S	66

Part number catalog cross referencing index

Former WH Part Number	Eaton Part Number	Catalog Page
9255X4X6	2046-4-6S	66
9255X6X4	2046-6-4S	66
9255X6X6	2046-6-6S	66
9255X6X8	2046-6-8S	66
9255X8X6	2046-8-6S	66
9255X8X8	2046-8-8S	66
9405X12X12	2047-12-12S	72
9405X12X16	2047-12-16S	72
9405X12X8	2047-12-8S	72
9405X16X12	2047-16-12S	72
9405X16X16	2047-16-16S	72
9405X2X2	2047-2-2S	72
9405X2X4	2047-2-4S	72
9405X20X20	2047-20-20S	72
9405X24X24	2047-24-24S	72
9405X32X32	2047-32-32S	72
9405X4X2	2047-4-2S	72
9405X4X4	2047-4-4S	72
9405X4X6	2047-4-6S	72
9405X4X8	2047-4-8S	72
9405X6X12	2047-6-12S	72
9405X6X4	2047-6-4S	72
9405X6X6	2047-6-6S	72
9405X6X8	2047-6-8S	72
9405X8X12	2047-8-12S	72
9405X8X6	2047-8-6S	72
9405X8X8	2047-8-8S	72
9455X12X12	2048-12-12S	71
9455X12X8	2048-12-8S	71
9455X16X16	2048-16-16S	71
9455X2X2	2048-2-2S	71
9455X20X20	2048-20-20S	71
9455X24X24	2048-24-24S	71
9455X4X4	2048-4-4S	71
9455X4X6	2048-4-6S	71
9455X4X8	2048-4-8S	71
9455X6X4	2048-6-4S	71
9455X6X6	2048-6-6S	71
9455X6X8	2048-6-8S	71
9455X8X12	2048-8-12S	71
9455X8X6	2048-8-6S	71
9455X8X8	2048-8-8S	71
9355X12X12	2049-12-12S	68
9355X12X16	2049-12-16S	68
9355X12X8	2049-12-8S	68
9355X16X12	2049-16-12S	68
9355X16X16	2049-16-16S	68
9355X16X20	2049-16-20S	68
9355X2X2	2049-2-2S	68
9355X20X20	2049-20-20S	68
9355X24X24	2049-24-24S	68
9355X4X2	2049-4-2S	68
9355X4X4	2049-4-4S	68
9355X4X6	2049-4-6S	68
9355X4X8	2049-4-8S	68
9355X6X4	2049-6-4S	68
9355X6X6	2049-6-6S	68
9355X6X8	2049-6-8S	68
9355X8X12	2049-8-12S	68
9355X8X6	2049-8-6S	68
9355X8X8	2049-8-8S	68
9385X12X12	2050-12-12S	67
9385X12X16	2050-12-16S	67
9385X16X16	2050-16-16S	67
9385X2X2	2050-2-2S	67
9385X20X20	2050-20-20S	67
9385X4X4	2050-4-4S	67
9385X4X6	2050-4-6S	67
9385X6X6	2050-6-6S	67
9385X6X8	2050-6-8S	67
9385X8X8	2050-8-8S	67
C5365X10	2061-10-10S	106
C5365X12X10	2061-10-12S	106
C5365X8X10	2061-10-8S	106
C5365X10X12	2061-12-10S	106
C5365X12	2061-12-12S	106
C5365X16X12	2061-12-16S	106
C5365X8X12	2061-12-8S	106

Former WH Part Number	Eaton Part Number	Catalog Page
C5365X14	2061-14-14S	106
C5365X12X16	2061-16-12S	106
C5365X16	2061-16-16S	106
C5365X20X16	2061-16-20S	106
C5365X16X20	2061-20-16S	106
C5365X20	2061-20-20S	106
C5365X4	2061-4-4S	106
C5365X5	2061-5-5S	106
C5365X4X6	2061-6-4S	106
C5365X6	2061-6-6S	106
C5365X8X6	2061-6-8S	106
C5365X10X8	2061-8-10S	106
C5365X6X8	2061-8-6S	106
C5365X8	2061-8-8S	106
C5515X10	2062-10-10S	107
C5515X12X10	2062-10-12S	107
C5515X6X10	2062-10-6S	107
C5515X8X10	2062-10-8S	107
C5515X10X12	2062-12-10S	107
C5515X12	2062-12-12S	107
C5515X16X12	2062-12-16S	107
C5515X20X12	2062-12-20S	107
C5515X8X12	2062-12-8S	107
C5515X16X14	2062-14-16S	107
C5515X10X16	2062-16-10S	107
C5515X12X16	2062-16-12S	107
C5515X16	2062-16-16S	107
C5515X20X16	2062-16-20S	107
C5515X8X16	2062-16-8S	107
C5515X16X20	2062-20-16S	107
C5515X20	2062-20-20S	107
C5515X24X20	2062-20-24S	107
C5515X20X24	2062-24-20S	107
C5515X24	2062-24-24S	107
C5515X4	2062-4-4S	107
C5515X5X4	2062-4-5S	107
C5515X6X4	2062-4-6S	107
C5515X4X5	2062-5-4S	107
C5515X5	2062-5-5S	107
C5515X6X5	2062-5-6S	107
C5515X4X6	2062-6-4S	107
C5515X5X6	2062-6-5S	107
C5515X6	2062-6-6S	107
C5515X8X6	2062-6-8S	107
C5515X10X8	2062-8-10S	107
C5515X12X8	2062-8-12S	107
C5515X6X8	2062-8-6S	107
C5515X8	2062-8-8S	107
C5515X10LL	206209-10-10S	106
C5515X12LL	206209-12-12S	106
C5515X16LL	206209-16-16S	106
C5515X6LL	206209-6-6S	106
C5515X10X8LL	206209-8-10S	106
C5515X8LL	206209-8-8S	106
9315X10X12	2066-12-10S	91
9315X12X12	2066-12-12S	91
9315X14X12	2066-12-14S	91
9315X16X12	2066-12-16S	91
9315X8X12	2066-12-8S	91
9315X16X16	2066-16-16S	91
9315X20X16	2066-16-20S	91
9315X20X20	2066-20-20S	91
9315x24x24	2066-24-24S	91
9315X4X4	2066-4-4S	91
9315X5X4	2066-4-5S	91
9315X6X4	2066-4-6S	91
9315X8X4	2066-4-8S	91
9315X10X6	2066-6-10S	91
9315X4X6	2066-6-4S	91
9315X6X6	2066-6-6S	91
9315X8X6	2066-6-8S	91
9315X10X8	2066-8-10S	91
9315X12X8	2066-8-12S	91
9315X6X8	2066-8-6S	91
9315X8X8	2066-8-8S	91
9365X12X12	2067-12-12S	92
9365X16X12	2067-12-16S	92
9365X8X12	2067-12-8S	92

Part number catalog cross referencing index

Former WH Part Number	Eaton Part Number	Catalog Page
9365X16X16	2067-16-16S	92
9365X20X20	2067-20-20S	92
9365X4X4	2067-4-4S	92
9365X4X6	2067-6-4S	92
9365X6X6	2067-6-6S	92
9365X8X6	2067-6-8S	92
9365X10X8	2067-8-10S	92
9365X6X8	2067-8-6S	92
9365X8X8	2067-8-8S	92
9515X10X12	2068-12-10S	93
9515X12X12	2068-12-12S	93
9515X16X12	2068-12-16S	93
9515X8X12	2068-12-8S	93
9515X16X16	2068-16-16S	93
9515X16X20	2068-20-16S	93
9515X20X20	2068-20-20S	93
9515X4X4	2068-4-4S	93
9515X6X4	2068-4-6S	93
9515X10X6	2068-6-10S	93
9515X4X6	2068-6-4S	93
9515X6X6	2068-6-6S	93
9515X8X6	2068-6-8S	93
9515X10X8	2068-8-10S	93
9515X12X8	2068-8-12S	93
9515X6X8	2068-8-6S	93
9515X8X8	2068-8-8S	93
C3459X12	206801-12-12S	93
C3459X16	206801-16-16S	93
C3459X20	206801-20-20S	93
C3459X6	206801-4-6S	93
C3459X8	206801-6-8S	93
C3459X10	206801-8-10S	93
C3459X8X8	206801-8-8S	93
C3469x12	206804-12-12S	93
C3469X16	206804-16-16S	93
C3469X8	206804-6-8S	93
C3469X10	206804-8-10S	93
C5356X10	2070-10-10S	97
C5356X12	2070-12-12S	97
C5356X14	2070-14-14S	97
C5356X16	2070-16-16S	97
C5356X20	2070-20-20S	97
C5356X4	2070-4-4S	97
C5356X5	2070-5-5S	97
C5356X6	2070-6-6S	97
C5356X8	2070-8-8S	97
C5506X10	2071-10-10S	98
C5506X8X10	2071-10-8S	98
C5506X12	2071-12-12S	98
C5506X14	2071-14-14S	98
C5506X16	2071-16-16S	98
C5506X20	2071-20-20S	98
C5506X24	2071-24-24S	98
C5506X32	2071-32-32S	98
C5506X4	2071-4-4S	98
C5506X6X4	2071-4-6S	98
C5506X5	2071-5-5S	98
C5506X4X6	2071-6-4S	98
C5506X6	2071-6-6S	98
C5506X10X8	2071-8-10S	98
C5506X6X8	2071-8-6S	98
C5506X8	2071-8-8S	98
C3959X12	2080-12-12S	76
C3959X16	2080-16-16S	76
C3959X2	2080-2-2S	76
C3959X4	2080-4-4S	76
C3959X6	2080-6-6S	76
C3959X8	2080-8-8S	76
C3109X12X4	2081-12-4S	63
C3109X12X6	2081-12-6S	63
C3109X12X8	2081-12-8S	63
C3109X16X12	2081-16-12S	63
C3109X16X4	2081-16-4S	63
C3109X16X6	2081-16-6S	63
C3109X16X8	2081-16-8S	63
C3109X20X12	2081-20-12S	63
C3109X20X16	2081-20-16S	63
C3109X20X8	2081-20-8S	63

Former WH Part Number	Eaton Part Number	Catalog Page
C3109X24X12	2081-24-12S	63
C3109X24X16	2081-24-16S	63
C3109X24X20	2081-24-20S	63
C3109X32X16	2081-32-16S	63
C3109X32X20	2081-32-20S	63
C3109X32X24	2081-32-24S	63
C3109X4X2	2081-4-2S	63
C3109X6X2	2081-6-2S	63
C3109X6X4	2081-6-4S	63
C3109X8X2	2081-8-2S	63
C3109X8X4	2081-8-4S	63
C3109X8X6	2081-8-6S	63
C3159X12	2082-12S	64
C3159X16	2082-16S	64
C3159X20	2082-20S	64
C3159X24	2082-24S	64
C3159X2	2082-2S	64
C3159X32	2082-32S	64
C3159X4	2082-4S	64
C3159X6	2082-6S	64
C3159X8	2082-8S	64
C3069X1	2083-1-1S	61
C3069X12	2083-12-12S	61
C3069X12X6	2083-12-6S	61
C3069X12X8	2083-12-8S	61
C3069X16X12	2083-16-12S	61
C3069X16	2083-16-16S	61
C3069X2X1	2083-2-1S	61
C3069X2	2083-2-2S	61
C3069X20X16	2083-20-16S	61
C3069X20	2083-20-20S	61
C3069X24	2083-24-24S	61
C3069X32	2083-32-32S	61
C3069X4X2	2083-4-2S	16
C3069X4	2083-4-4S	16
C3069X6X2	2083-6-2S	16
C3069X6X4	2083-6-4S	16
C3069X6	2083-6-6S	61
C3069X8X4	2083-8-4S	61
C3069X8X6	2083-8-6S	61
C3069X8	2083-8-8S	61
C3529X12	2085-12-12S	69
C3529X12X8	2085-12-8S	69
C3529X16X12	2085-16-12S	69
C3529X16	2085-16-16S	69
C3529X2	2085-2-2S	69
C3529X4	2085-4-4S	69
C3529X6X4	2085-6-4S	69
C3529X6	2085-6-6S	69
C3529X8X6	2085-8-6S	69
C3529X8	2085-8-8S	69
C3559X12	2086-12-12S	69
C3559X16	2086-16-16S	69
C3559X4	2086-4-4S	69
C3559X6	2086-6-6S	69
C3559X8	2086-8-8S	69
C3509X12	2087-12-12S	73
C3509X12X8	2087-12-8S	73
C3509X16X12	2087-16-12S	73
C3509X16	2087-16-16S	73
C3509X2	2087-2-2S	73
C3509X20	2087-20-20S	73
C3509X24	2087-24-24S	73
C3509X4X2	2087-4-2S	73
C3509X4	2087-4-4S	73
C3509X6X4	2087-6-4S	73
C3509X6	2087-6-6S	73
C3509X8X6	2087-8-6S	73
C3509X8	2087-8-8S	73
C3359X12	2088-12-12S	68
C3359X16	2088-16-16S	68
C3359X2	2088-2-2S	68
C3359X4	2088-4-4S	68
C3359X6	2088-6-6S	68
C3359X8	2088-8-8S	68
C3409X12	2089-12-12S	70
C3409X12X8	2089-12-8S	70
C3409X16	2089-16-16S	70

Part number catalog cross referencing index

Former WH Part Number	Eaton Part Number	Catalog Page
C3409X2	2089-2-2S	70
C3409X2X4	2089-2-4S	70
C3409X20	2089-20-20S	70
C3409X24	2089-24-24S	70
C3409X32	2089-32-32S	70
C3409X4X2	2089-4-2S	70
C3409X4	2089-4-4S	70
C3409X4X6	2089-4-6S	70
C3409X6X4	2089-6-4S	70
C3409X6	2089-6-6S	70
C3409X6X8	2089-6-8S	70
C3409X8X12	2089-8-12S	70
C3409X8X6	2089-8-6S	70
C3409X8	2089-8-8S	70
C3709X12	2090-12-12S	76
C3709X16	2090-16-16S	76
C3709X2	2090-2-2S	76
C3709X20	2090-20-20S	76
C3709X24	2090-24-24S	76
C3709X4	2090-4-4S	76
C3709X6	2090-6-6S	76
C3709X8	2090-8-8S	76
C3609X12	2091-12-12S	76
C3609X16	2091-16-16S	76
C3609X2	2091-2-2S	76
C3609X4	2091-4-4S	76
C3609X6	2091-6-6S	76
C3609X8	2091-8-8S	76
C3759X12	2092-12-12S	74
C3759X16	2092-16-16S	74
C3759X2	2092-2-2S	74
C3759X20	2092-20-20S	74
C3759X4	2092-4-4S	74
C3759X6	2092-6-6S	74
C3759X8	2092-8-8S	74
C3805X12	2093-12-12S	74
C3805X16	2093-16-16S	74
C3805X2	2093-2-2S	74
C3805X4	2093-4-4S	74
C3805X6	2093-6-6S	74
C3805X8	2093-8-8S	74
C3309X12X8	2096-12-8S	67
C3309X12	2096-12S	67
C3309X16X12	2096-16-12S	67
C3309X16	2096-16S	67
C3309X20	2096-20S	67
C3309X24	2096-24S	67
C3309X2	2096-2S	67
C3309X32	2096-32S	67
C3309X4X2	2096-4-2S	67
C3309X4	2096-4S	67
C3309X6X4	2096-6-4S	67
C3309X6	2096-6S	67
C3309X8X4	2096-8-4S	67
C3309X8X6	2096-8-6S	67
C3309X8	2096-8S	67
C5924X10	210212-10S	102
C5924X12	210212-12S	102
C5924X16	210212-16S	102
C5924X20	210212-20S	102
C5924X24	210212-24S	102
C5924X3	210212-3S	102
C5924X4	210212-4S	102
C5924X5	210212-5S	102
C5924X6	210212-6S	102
C5924X8	210212-8S	102
C5129X10	210292-10S	96
C5129X12	210292-12S	96
C5129X16	210292-16S	96
C5129X20	210292-20S	96
C5129X24	210292-24S	96
C5129X2	210292-2S	96
C5129X32	210292-32S	96
C5129X3	210292-3S	96
C5129X4	210292-4S	96
C5129X5	210292-5S	96
C5129X6	210292-6S	96
C5129X8	210292-8S	96

Former WH Part Number	Eaton Part Number	Catalog Page
C5115X10	221000-10S	126
C5115X12	221000-12S	126
C5115X14	221000-14S	126
C5115X16	221000-16S	126
C5115X4	221000-4S	126
C5115X5	221000-5S	126
C5115X6	221000-6S	126
C5115X8	221000-8S	126
C5015X10X4	2215-10-4S	96
C5015X10X6	2215-10-6S	96
C5015X10X8	2215-10-8S	96
C5015X12X10	2215-12-10S	96
C5015X14X8	2215-14-8S	96
C5015X16X10	2215-16-10S	96
C5015X16X8	2215-16-8S	96
C5015X20X16	2215-20-16S	96
C5015x24x16	2215-24-16S	96
C5015X24X20	2215-24-20S	96
C5015X24X32	2215-24-32S	96
C5015X32X24	2215-32-24S	96
C5015x6x5	2215-6-5S	96
C5015X16X6	221501-16-6S	97
C3269X10X12	2216-12-10S	92
C3269X12X12	2216-12-12S	92
C3269X14X12	2216-12-14S	92
C3269X16X12	2216-12-16S	92
C3269X16X16	2216-16-16S	92
C3269X20X16	2216-16-20S	92
C3269X4X2	2216-2-4S	92
C3269X5X2	2216-2-5S	92
C3269X20X20	2216-20-20S	92
C3269X24X24	2216-24-24S	92
C3269X32X32	2216-32-32S	92
C3269X10X4	2216-4-10S	92
C3269X4X4	2216-4-4S	92
C3269X5X4	2216-4-5S	92
C3269X6X4	2216-4-6S	92
C3269X8X4	2216-4-8S	92
C3269X10X6	2216-6-10S	92
C3269X12X6	2216-6-12S	92
C3269X6X6	2216-6-6S	92
C3269X8X6	2216-6-8S	92
C3269X10X8	2216-8-10S	92
C3269X12X8	2216-8-12S	92
C3269X16X8	2216-8-16S	92
C3269X6X8	2216-8-6S	92
C3269X8X8	2216-8-8S	92
C5314X10X10	2220-10-10S	59
C5314X12X12	2220-12-12S	59
C5314X16X16	2220-16-16S	59
C5314X20X20	2220-20-20S	59
C5314X24X24	2220-24-24S	59
C5314X4X4	2220-4-4S	59
C5314X6X6	2220-6-6S	59
C5314X8X8	2220-8-8S	59
C3169X1	2222-1S	65
C3169X2	2222-2S	65
C3169X4	2222-4S	65
C3169X6	2222-6S	65
C5275X12	2239-1-12-12S	79
C5275X16	2239-1-16-16S	79
C5275X4	2239-1-2-4S	79
C5275X6	2239-1-4-6S	79
C5275X8	2239-1-6-8S	79
C5275X10	2239-1-8-10S	79
C5256X12	2242-12-12S	79
C5256X14	2242-12-14S	79
C5256X16	2242-16-16S	79
C5256X4	2242-2-4S	79
C5256X5	2242-2-5S	79
C5256X20	2242-20-20S	79
C5256X4X4	2242-4-4S	79
C5256X5X4	2242-4-5S	79
C5256X6	2242-4-6S	79
C5256X6X6	2242-6-6S	79
C5256X8	2242-6-8S	79
C5256X10	2242-8-10S	79
C5256X6X8	2242-8-6S	79

Part number catalog cross referencing index

Former WH Part Number	Eaton Part Number	Catalog Page
C5256X8X8	2242-8-8S	79
C3239X12X12	2246-12-12S	91
C3239X14X12	2246-12-14S	91
C3239X16X16	2246-16-16S	91
C3239X4X2	2246-2-4S	91
C3239X5X2	2246-2-5S	91
C3239X6X4	2246-4-6S	91
C3239X6X6	2246-6-6S	91
C3239X8X6	2246-6-8S	91
C3239X10X8	2246-8-10S	91
C3239X6X8	2246-8-6S	91
C3239X8X8	2246-8-8S	91
C5406X12	2250-12-12S	84
C5406X14	2250-12-14S	84
C5406X8X12	2250-12-8S	84
C5406X16	2250-16-16S	84
C5406X4	2250-2-4S	84
C5406X5	2250-2-5S	84
C5406X20	2250-20-20S	84
C5406X24	2250-24-24S	84
C5406X32	2250-32-32S	84
C5406X4X4	2250-4-4S	84
C5406X6	2250-4-6S	84
C5406X8	2250-6-8S	84
C5406X10	2250-8-10S	84
9435X12X12	2251-12-12S	70
9435X4X4	2251-4-4S	70
9435X6X6	2251-6-6S	70
9435X8X8	2251-8-8S	70
9456X12X12X12	2253-12-12S	75
9456X6X6X6	2253-6-6S	75
9456X8X8X8	2253-8-8S	75
9406X12	2254-12-12S	75
9406X2X2X2	2254-2-2S	75
9406X4X4X4	2254-4-4S	75
9406X4X4X6	2254-4-6S	75
9406X4X4X8	2254-4-8S	75
9406X6X6X6	2254-6-6S	75
9406X6X6X8	2254-6-8S	75
9406X8X8X8	2254-8-8S	75
9705X12X12X12	2255-12-12S	75
9705X2X2X2	2255-2-2S	75
9705X4X4X4	2255-4-4S	75
9705X6X6X6	2255-6-6S	75
9705X8X8X8	2255-8-8S	75
7629X1	22617-1	112
7629X10	22617-10	112
7629X12	22617-12	112
7629X14	22617-14	112
7629X16	22617-16	112
7629X2	22617-2	112
7629X20	22617-20	112
7629X24	22617-24	112
7629X3	22617-3	112
7629X4	22617-4	112
7629X5	22617-5	112
7629X6	22617-6	112
7629X7	22617-7	112
7629X8	22617-8	112
C5216X10X10	2266-10-10S	105
C5216X12X12	2266-12-12S	105
C5216X16X12	2266-12-16S	105
C5216X16X16	2266-16-16S	105
C5216X20X20	2266-20-20S	105
C5216X24X24	2266-24-24S	105
C5216X4X4	2266-4-4S	105
C5216X4X6	2266-6-4S	105
C5216X6X6	2266-6-6S	105
C5216X8X6	2266-6-8S	105
C5216X6X8	2266-8-6S	105
C5216X8X8	2266-8-8S	105
5117X10	259-1290-10	127
5117X12	259-1290-12	127
5117X16	259-1290-16	127
5117X20	259-1290-20	127
5117X24	259-1290-24	127
5117X32	259-1290-32	127
5117X4	259-1290-4	127

Former WH Part Number	Eaton Part Number	Catalog Page
5117X6	259-1290-6	127
5117X8	259-1290-8	127
5217X10X12	259-2021-12-10	77
5217X12	259-2021-12-12	77
5217X16X12	259-2021-12-16	77
5217X8X12	259-2021-12-8	77
5217X16	259-2021-16-16	77
5217X4	259-2021-2-4	77
5217X16X20	259-2021-20-16	77
5217X20	259-2021-20-20	77
5217X24X20	259-2021-20-24	77
5217X24	259-2021-24-24	77
5217X32	259-2021-32-32	77
5217X4X4	259-2021-4-4	77
5217X5X4	259-2021-4-5	77
5217X6	259-2021-4-6	77
5217X8X4	259-2021-4-8	77
5217X10X6	259-2021-6-10	77
5217X4X6	259-2021-6-4	77
5217X6X6	259-2021-6-6	77
5217X8	259-2021-6-8	77
5217X10	259-2021-8-10	77
5217X12X8	259-2021-8-12	77
5217X6X8	259-2021-8-6	77
5217X8X8	259-2021-8-8	77
5267x16	259-2022-16-16	80
5267x4x4	259-2022-4-4	80
5267x6x6	259-2022-6-6	80
5267x8	259-2022-6-8	80
5267x8x8	259-2022-8-8	80
5367X6	259-2023-4-6	81
5417x16	259-2024-16-16	82
5417x4	259-2024-2-4	82
5417x4x4	259-2024-4-4	82
5417x6	259-2024-4-6	82
5417x8x8	259-2024-8-8	82
5317x12	259-2027-12-12	94
5317x16	259-2027-16-16	94
5317x4	259-2027-4-4	94
5317X6	259-2027-6-6	94
5317x8	259-2027-8-8	94
5327x12	259-202702-12-12	104
5327x16	259-202702-16-16	104
5327x8x16	259-202702-16-8	104
5327X4	259-202702-4-4	104
5327X6	259-202702-6-6	104
5327x6x8	259-202702-8-6	104
5327x8	259-202702-8-8	104
5337X8	259-2041-1-8-8	95
5518x4	259-2071-4-4	98
5518x6	259-2071-6-6	98
3121X12X4	259-2081-12-4	63
3121X16X12	259-2081-16-12	63
3121X16X8	259-2081-16-8	63
3121X20X12	259-2081-20-12	63
3121X20X16	259-2081-20-16	63
3121X32X16	259-2081-32-16	63
3121X32X20	259-2081-32-20	63
3121X4X2	259-2081-4-2	63
3121X6X2	259-2081-6-2	63
3121X6X4	259-2081-6-4	63
3121X8X4	259-2081-8-4	63
3121X8X6	259-2081-8-6	63
3171X16	259-2082-16	64
3171X2	259-2082-2	64
3171X4	259-2082-4	64
3171X6	259-2082-6	64
3081X12	259-2083-12-12	61
3081X16	259-2083-16-16	61
3081X2	259-2083-2-2	61
3081x20	259-2083-20-20	61
3081x24	259-2083-24-24	61
3081x4x2	259-2083-4-2	61
3081X4	259-2083-4-4	61
3081X6X4	259-2083-6-4	61
3081x6	259-2083-6-6	61
3081X8	259-2083-8-8	61
3521X4	259-2087-4-4	73

Part number catalog cross referencing index

Former WH Part Number	Eaton Part Number	Catalog Page
3421X6	259-2089-6-6	70
3321X12	259-2096-12	67
3321X20	259-2096-20	67
3321X4	259-2096-4	67
3321X4X2	259-2096-4-2	67
3321X6	259-2096-6	67
3321X8	259-2096-8	67
7936x12	259-210212-12	102
7936x6	259-210212-6	102
7936x8	259-210212-8	102
5141x4	259-210292-4	96
5141X8	259-210292-8	96
5241x12	259-900599-12	95
5241x6	259-900599-6	95
5177X10	259-900605-10	127
5177X12	259-900605-12	127
5177X16	259-900605-16	127
5177X20	259-900605-20	127
5177X24	259-900605-24	127
5177X4	259-900605-4	127
5177X6	259-900605-6	127
5177X8	259-900605-8	127
9205X4X4Z	307-2045-4-4	66
C3159X24Z	307-2082-24	64
C3159X8Z	307-2082-8	64
54508x12	500023-12-8S	117
54512	500023-12S	117
54520X16	500023-16-20S	117
54516	500023-16S	117
54516X20	500023-20-16S	117
54508	500023-8S	117
59008X12	500024-12-8S	118
59008	500024-8S	118
50008X12	500025-12-8S	116
50012	500025-12S	116
50016	500025-16S	116
50016X20	500025-20-16S	116
50020	500025-20S	116
50024	500025-24S	116
50008	500025-8S	116
B7237X10	900598-1-10S	58
B7237X12	900598-1-12S	58
B7237X14	900598-1-14S	58
B7237X16	900598-1-16S	58
B7237X20	900598-1-20S	58
B7237X24	900598-1-24S	58
B7237X2	900598-1-2S	58
B7237X32	900598-1-32S	58
B7237X3	900598-1-3S	58
B7237X4	900598-1-4S	58
B7237X5	900598-1-5S	58
B7237X6	900598-1-6S	58
B7237X8	900598-1-8S	58
7237X10	900598-10S	58
7237X12	900598-12S	58
7237X14	900598-14S	58
7237X16	900598-16S	58
7237X20	900598-20S	58
7237X24	900598-24S	58
7237X2	900598-2S	58
7237X32	900598-32S	58
7237X3	900598-3S	58
7237X4	900598-4S	58
7237X5	900598-5S	58
7237X6	900598-6S	58
7237X8	900598-8S	58
C5229X10	900599-10S	95
C5229X12	900599-12S	95
C5229X14	900599-14S	95
C5229X16	900599-16S	95
C5229X20	900599-20S	95
C5229X24	900599-24S	95
C5229X32	900599-32S	95
C5229X3	900599-3S	95
C5229X4	900599-4S	95
C5229X5	900599-5S	95
C5229X6	900599-6S	95
C5229X8	900599-8S	95
C5165X10	900605-10S	127

Former WH Part Number	Eaton Part Number	Catalog Page
C5165X12	900605-12S	127
C5165X14	900605-14S	127
C5165X16	900605-16S	127
C5165X20	900605-20S	127
C5165X24	900605-24S	127
C5165X2	900605-2S	127
C5165X32	900605-32S	127
C5165X3	900605-3S	127
C5165X4	900605-4S	127
C5165X5	900605-5S	127
C5165X6	900605-6S	127
C5165X8	900605-8S	127
4165X4	FC1229-0404S	41
4165X6	FC1229-0606S	41
4165X8	FC1229-0808S	41
4165X12	FC1229-1212S	41
4165X16	FC1229-1616S	41
4165X20	FC1229-2020S	41
4165X24	FC1229-2424S	41
4105X4	FC2326-04S	43
4105X6	FC2326-06S	43
4105X8	FC2326-08S	43
4105X10	FC2326-10S	43
4105X12	FC2326-12S	43
4105X16	FC2326-16S	43
4105X20	FC2326-20S	43
4105X24	FC2326-24S	43
7033X4X6	FF1010-0406S	58
7033X4X8	FF1010-0408S	58
7033X6X4	FF1010-0604S	58
7033X8X6	FF1010-0806S	58
7033X10X8	FF1010-1008S	58
7033X12X6	FF1010-1206S	58
7033X12X8	FF1010-1208S	58
7033X12X10	FF1010-1210S	58
7033X12X16	FF1010-1216S	58
7033X14X12	FF1010-1412S	58
7033X16X8	FF1010-1608S	58
7033X16X10	FF1010-1610S	58
7033X16X12	FF1010-1612S	58
7033X20X12	FF1010-2012S	58
7033X20X16	FF1010-2016S	58
7033X24X12	FF1010-2412S	58
7033X24X20	FF1010-2420S	58
C5015X6X4	FF1066-0604S	97
C5015X8X4	FF1066-0804S	97
C5015X8X6	FF1066-0806S	97
C5015X12X4	FF1066-1204S	97
C5015X12X6	FF1066-1206S	97
C5015X12X8	FF1066-1208S	97
C5015X16X12	FF1066-1612S	97
C5015X20X12	FF1066-2012S	97
C3249X4X2	FF1796-0402S	59
C3249X6X4	FF1796-0604S	59
C3249X8X6	FF1796-0806S	59
C3249X8X8	FF1796-0808S	59
C3249X10X8	FF1796-1008S	59
C3249X12X12	FF1796-1212S	59
C3249X16X16	FF1796-1616S	59
C3249X20X20	FF1796-2020S	59
C3249X24X24	FF1796-2424S	59
C3249X32X32	FF1796-3232S	59
4315X4X3	FF1852T0403S	44
4315X4	FF1852T0404S	44
4315X4X5	FF1852T0405S	44
4315X4X6	FF1852T0406S	44
4315X4X8	FF1852T0408S	44
4315X6X3	FF1852T0603S	44
4315X6X4	FF1852T0604S	44
4315X6X5	FF1852T0605S	44
4315X6	FF1852T0606S	44
4315X6X8	FF1852T0608S	44
4315X6X10	FF1852T0610S	44
4315X6X12	FF1852T0612S	44
4315X6X16	FF1852T0616S	44
4315X8X6	FF1852T0806S	44
4315X8	FF1852T0808S	44
4315X8X10	FF1852T0810S	44

Part number catalog cross referencing index

Former WH Part Number	Eaton Part Number	Catalog Page
4315X8X12	FF1852T0812S	44
4315X8X14	FF1852T0814S	44
4315X8X16	FF1852T0816S	44
4315X10X8	FF1852T1008S	44
4315X10	FF1852T1010S	44
4315X12X6	FF1852T1206S	44
4315X12X8	FF1852T1208S	44
4315X12X10	FF1852T1210S	44
4315X12	FF1852T1212S	44
4315X12X14	FF1852T1214S	44
4315X12X16	FF1852T1216S	44
4315X16X8	FF1852T1608S	44
4315X16X10	FF1852T1610S	44
4315X16X12	FF1852T1612S	44
4315X16X14	FF1852T1614S	44
4315X16	FF1852T1616S	44
4315X16X20	FF1852T1620S	44
4315X20X16	FF1852T2016S	44
4315X20	FF1852T2020S	44
4315X24X20	FF1852T2420S	44
4316X4	FF1854T0404S	45
4316X6	FF1854T0606S	45
4316X8	FF1854T0808S	45
4316X10	FF1854T1010S	45
4316X12	FF1854T1212S	45
4316X16	FF1854T1616S	45
4316X20	FF1854T2020S	45
4316X24	FF1854T2424S	45
4707X4	FF1857T0404S	55
4707X6	FF1857T0606S	55
4707X8	FF1857T0808S	55
4707X10	FF1857T1010S	55
4707X12	FF1857T1212S	55
4707X16	FF1857T1616S	55
4707X20	FF1857T2020S	55
4715X4	FF1861T0404S	48
4715X6	FF1861T0606S	48
4715X8X6	FF1861T0806S	48
4715X8	FF1861T0808S	48
4715X10	FF1861T1010S	48
4715X12	FF1861T1212S	48
4715X12X16	FF1861T1216S	48
4715X16	FF1861T1616S	48
4716X4	FF1865T0404S	48
4716x4x6	FF1865T0406S	48
4716X6	FF1865T0606S	48
4716X8	FF1865T0808S	48
4716X12	FF1865T1212S	48
4515X4	FF1868T0404S	46
4515X4X5	FF1868T0405S	46
4515X4X6	FF1868T0406S	46
4515X4X8	FF1868T0408S	46
4515X6X4	FF1868T0604S	46
4515X6X5	FF1868T0605S	46
4515X6	FF1868T0606S	46
4515X6X8	FF1868T0608S	46
4515X6X10	FF1868T0610S	46
4515X6X12	FF1868T0612S	46
4515X8X6	FF1868T0806S	46
4515X8	FF1868T0808S	46
4515X8X10	FF1868T0810S	46
4515X8X12	FF1868T0812S	46
4515X10X8	FF1868T1008S	46
4515X10	FF1868T1010S	46
4515X10X12	FF1868T1012S	46
4515X12X8	FF1868T1208S	46
4515X12X10	FF1868T1210S	46
4515X12	FF1868T1212S	46
4515X12X14	FF1868T1214S	46
4515X12X16	FF1868T1216S	46
4515X16X12	FF1868T1612S	46
4515X16X14	FF1868T1614S	46
4515X16	FF1868T1616S	46
4515X16X20	FF1868T1620S	46
4515X20X12	FF1868T2012S	46
4515X20X16	FF1868T2016S	46
4515X20	FF1868T2020S	46
4515X24X20	FF1868T2420S	46

Former WH Part Number	Eaton Part Number	Catalog Page
4515X24	FF1868T2424S	46
4705X4	FF1898T0404S	54
4705X6	FF1898T0606S	54
4705X6X6X8	FF1898T0608S	54
4705X8	FF1898T0808S	54
4705X10	FF1898T1010S	54
4705X12	FF1898T1212S	54
4325X6	FF1994H4-0606S	53
4325X8	FF1994H4-0808S	53
4325X10	FF1994H4-1010S	53
4325X12	FF1994H4-1212S	53
4325X16	FF1994H4-1616S	53
4305X4	FF2000T0404S	52
4305X6X4	FF2000T0604S	52
4305X6	FF2000T0606S	52
4305X8X6	FF2000T0806S	52
4305X8	FF2000T0808S	52
4305X10X8	FF2000T1008S	52
4305X10	FF2000T1010S	52
4305X12X8	FF2000T1208S	52
4305X12X10	FF2000T1210S	52
4305X12	FF2000T1212S	52
4305X16X12	FF2000T1612S	52
4305X16	FF2000T1616S	52
4305X20	FF2000T2020S	52
4305X24	FF2000T2424S	52
4525X6	FF2030H4-0606S	54
4525X8	FF2030H4-0808S	54
4525X12	FF2030H4-1212S	54
4525X16	FF2030H4-1616S	54
4205X4	FF2031T0402S	49
4205X4X6	FF2031T0406S	49
4205X4X8	FF2031T0408S	49
4205X6X2	FF2031T0602S	49
4205X6	FF2031T0604S	49
4205X6X6	FF2031T0606S	49
4205X6X8	FF2031T0608S	49
4205X8X4	FF2031T0804S	49
4205X8	FF2031T0806S	49
4205X8X8	FF2031T0808S	49
4205X8X12	FF2031T0812S	49
4205X10	FF2031T1008S	49
4205X10X12	FF2031T1012S	49
4205X12X8	FF2031T1208S	49
4205X12	FF2031T1212S	49
4205X12X16	FF2031T1216S	49
4205X16X12	FF2031T1612S	49
4205X16	FF2031T1616S	49
4205X16X20	FF2031T1620S	49
4205X20X16	FF2031T2016S	49
4205X20	FF2031T2020S	49
4205X24	FF2031T2424S	49
4405X4	FF2032T0402S	50
4405X6	FF2032T0604S	50
4405X8	FF2032T0806S	50
4405X10	FF2032T1008S	50
4405X12	FF2032T1212S	50
4405X16	FF2032T1616S	50
4405X20	FF2032T2020S	50
4405X24	FF2032T2424S	50
4505X4	FF2035T0404S	54
4505X4X6	FF2035T0604S	54
4505X6	FF2035T0606S	54
4505X8	FF2035T0808S	54
4505X10	FF2035T1010S	54
4505X12	FF2035T1212S	54
4505X16	FF2035T1616S	54
4505X20	FF2035T2020S	54
4365X4	FF2068T0404S	47
4365X4X6	FF2068T0406S	47
4365X4X8	FF2068T0408S	47
4365X6X4	FF2068T0604S	47
4365X6	FF2068T0606S	47
4365X6X8	FF2068T0608S	47
4365X8X6	FF2068T0806S	47
4365X8	FF2068T0808S	47
4365X8X10	FF2068T0810S	47
4365X8X16	FF2068T0816S	47

Part number catalog cross referencing index

Former WH Part Number	Eaton Part Number	Catalog Page
4365X10X8	FF2068T1008S	47
4365X10	FF2068T1010S	47
4365X10X12	FF2068T1012S	47
4365X12X10	FF2068T1210S	47
4365X12	FF2068T1212S	47
4365X12X16	FF2068T1216S	47
4365X16X12	FF2068T1612S	47
4365X16	FF2068T1616S	47
4365X16X20	FF2068T1620S	47
4365X20	FF2068T2020S	47
4365X24	FF2068T2424S	47
4355X4	FF2093T0402S	49
4355X6	FF2093T0604S	49
4355X8	FF2093T0806S	49
4355X12	FF2093T1212S	49
4506X4	FF2098T0404S	53
4506X6	FF2098T0606S	53
4506X8	FF2098T0808S	53
4506X10	FF2098T1010S	53
4506X12	FF2098T1212S	53
4506X16	FF2098T1616S	53
4506X20	FF2098T2020S	53
4506X24	FF2098T2424S	53
4706X4	FF2114T0404S	55
4706X6	FF2114T0606S	55
4706X8	FF2114T0808S	55
4706X10	FF2114T1010S	55
4706X12	FF2114T1212S	55
4706X16	FF2114T1616S	55
4706X20	FF2114T2020S	55
4706X24	FF2114T2424S	55
B7238x2	FF2137-02S	59
B7238X3	FF2137-03S	59
B7238X4	FF2137-04S	59
B7238X5	FF2137-05S	59
B7238x6	FF2137-06S	59
B7238X8	FF2137-08S	59
B7238X10	FF2137-10S	59
B7238X12	FF2137-12S	59
B7238X14	FF2137-14S	59
B7238X16	FF2137-16S	59
B7238X20	FF2137-20S	59
7238X2	FF2138-02S	59
7238X3	FF2138-03S	59
7238X4	FF2138-04S	59
7238X5	FF2138-05S	59
7238X6	FF2138-06S	59
7238X8	FF2138-08S	59
7238X10	FF2138-10S	59
7238X12	FF2138-12S	59
7238X14	FF2138-14S	59
7238X16	FF2138-16S	59
7238X20	FF2138-20S	59
4375X4	FF2144H4-0404S	53
4375X6	FF2144H4-0606S	53
4375X8	FF2144H4-0808S	53
4726X4	FF2174T0404S	55
4726X6	FF2174T0606S	55
4726X8	FF2174T0808S	55
4726X12	FF2174T1212S	55
4726X16	FF2174T1616S	55
4726X20	FF2174T2020S	55
4213X4	FF2209T0404S	51
4213X12X4	FF2209T0412S	51
4213X6	FF2209T0606S	51
4213X12X6	FF2209T0612S	51
4213X8	FF2209T0808S	51
4213X12X8	FF2209T0812S	51
4213X10	FF2209T1010S	51
4213X12	FF2209T1212S	51
4213X16	FF2209T1616S	51
4213X16X20	FF2209T2016S	51
4213X20	FF2209T2020S	51
4515X4L	FF2227T0404S	47
4515X6L	FF2227T0606S	47
4515X8L	FF2227T0808S	47
4515X10L	FF2227T1010S	47
4515X12L	FF2227T1212S	47
4515X16L	FF2227T1616S	47

Former WH Part Number	Eaton Part Number	Catalog Page
4515X20L	FF2227T2020S	47
C5515X6L	FF3910-0606S	106
C5515X8L	FF3910-0808S	106
C5515X12L	FF3910-1212S	106
9154X6X6	FF4174-0606S	103
9154X8X8	FF4174-0808S	103
9154X10X10	FF4174-1010S	103
9405X2X2LL	FF4175-0202S	72
9405X4X4LL	FF4175-0404S	72
9405X6X6LL	FF4175-0606S	72
9405X8X8LL	FF4175-0808S	72
9405X12X12LL	FF4175-1212S	72
9405X16X16LL	FF4175-1616S	72
C3179X2	FF4177-02S	64
C3179X4	FF4177-04S	64
C3179X6	FF4177-06S	64
C3179X8	FF4177-08S	64
C3179X12	FF4177-12S	64
C3179X16	FF4177-16S	64
M9600X4X4	FF4179-0404S	137
M9600X5X4	FF4179-0504S	137
M9600X6X4	FF4179-0604S	137
M9600X6X6	FF4179-0606S	137
M9600X8X6	FF4179-0806S	137
M9600X8X8	FF4179-0808S	137
M9600X10X8	FF4179-1008S	137
M9600X12X12	FF4179-1212S	137
M9600X16X16	FF4179-1616S	137
M9600X20X20	FF4179-2020S	137
M9700X4X6	FF4180-0406S	135
M9700X5X8	FF4180-0508S	135
M9700X6X10	FF4180-0610S	135
M9700X8X12	FF4180-0812S	135
M9700X10X14	FF4180-1014S	135
M9700X12X20	FF4180-1220S	135
M9700X16X25	FF4180-1625S	135
M9700X20X32	FF4180-2032S	135
M9800X4X4	FF4181-0404S	138
M9800X5X4	FF4181-0504S	138
M9800X6X4	FF4181-0604S	138
M9800X8X4	FF4181-0804S	138
M9800X8X6	FF4181-0806S	138
M9800X8X8	FF4181-0808S	138
M9800X10X8	FF4181-1008S	138
M9800X12X8	FF4181-1208S	138
M9800X12X12	FF4181-1212S	138
M9800X16X12	FF4181-1612S	138
M9800X16X16	FF4181-1616S	138
M9800X20X20	FF4181-2020S	138
W21204	FF4183-0404-1S	62
W05465	FF4183-0404-2S	62
W17709	FF4183-0606S	62
41157X4	FF4184-0404S	129
41157X6	FF4184-0606S	129
41157X8	FF4184-0808S	129
41157X10	FF4184-1010S	129
41157X12	FF4184-1212S	129
W05498	FF4185-0804-1S	62
W05499	FF4185-0804-2S	62
W05730	FF4186-0804-1S	62
W23464	FF4186-0804-2S	62
M41157X6X14	FF4215-0614S	132
M41157X6X16	FF4215-0616S	132
M41157X6X18	FF4215-0618S	132
59012	FF5162-1212S	118
59016	FF5162-1616S	118
59020X16	FF5162-1620S	118
59016X20	FF5162-2016S	118
59020	FF5162-2020S	118
59024	FF5162-2424S	118
59032	FF5162-3232S	118
54520	FF5238-2020S	117
54524	FF5238-2424S	117
54532	FF5238-3232S	117
50032	FF5239-3232S	116
64512	FF5539-1212S	117
64512X16	FF5539-1612S	117
64516	FF5539-1616S	117
64516X20	FF5539-2016S	117

Part number catalog cross referencing index

Former WH Part Number	Eaton Part Number	Catalog Page	Former WH Part Number	Eaton Part Number	Catalog Page
64520	FF5539-2020S	117	MC5315X10X20	GG108-NP10-20	133
64516X24	FF5539-2416S	117	MC5315X12X22	GG108-NP12-22	133
64520X24	FF5539-2420S	117	MC5315X12X27	GG108-NP12-27	133
64524	FF5539-2424S	117	MC5315X16X33	GG108-NP16-33	133
60012	FF5541-1212S	116	MC5315X20X42	GG108-NP20-42	133
60016	FF5541-1616S	116	MC5205X4X2	GG110-NP04-02	137
60020	FF5541-2020S	116	MC5205X4X4	GG110-NP04-04	137
60024	FF5541-2424S	116	MC5205X6X4	GG110-NP06-04	137
C5165X4X6MM	FF91488-0406S	135	MC5205X6X6	GG110-NP06-06	137
C5165X5X8MM	FF91488-0508S	135	MC5205X8X6	GG110-NP08-06	137
C5165X6X10MM	FF91488-0610S	135	MC5205X8X8	GG110-NP08-08	137
C5165X8X12MM	FF91488-0812S	135	MC5205X10X8	GG110-NP10-08	137
C5165X10X14MM	FF91488-1014S	135	MC5205X12X12	GG110-NP12-12	137
C5165X10X15MM	FF91488-1015S	135	MC5205X16X16	GG110-NP16-16	137
C5165X10X16MM	FF91488-1016S	135	MB5515X4X4	GG306-NP04-04	137
C5165X12X18MM	FF91488-1218S	135	MB5515X5X4	GG306-NP05-04	137
C5165X14X20MM	FF91488-1420S	135	MB5515X6X4	GG306-NP06-04	137
C5165X20X30MM	FF91488-2030S	135	MB5515X6X6	GG306-NP06-06	137
C5165X20X32MM	FF91488-2032S	135	MB5515X8X6	GG306-NP08-06	137
C3059X12	FF91494-12S	64	MB5515X8X8	GG306-NP08-08	137
C3059X16	FF91494-16S	64	MB5515X10X12	GG306-NP10-12	137
C3059X2	FF91494-2S	64	MB5515X12X12	GG306-NP12-12	137
C3059X4	FF91494-4S	64	MB5515X16X16	GG306-NP16-16	137
C3059X6	FF91494-6S	64	MB5515X20X20	GG306-NP20-20	137
C3059X8	FF91494-8S	64	MC5515X4X10	GG308-NP04-10	133
4229X4	FF9767T04-S	56	MC5515X4X12	GG308-NP04-12	133
4229X6	FF9767T06-S	56	MC5515X6X14	GG308-NP06-14	133
4229X8	FF9767T08-S	56	MC5515X6X16	GG308-NP06-16	133
4229X10	FF9767T10-S	56	MC5515X8X18	GG308-NP08-18	133
4229X12	FF9767T12-S	56	MC5515X8X22	GG308-NP08-22	133
4229X16	FF9767T16-S	56	MC5515X10X18	GG308-NP10-18	133
4229X20	FF9767T20-S	56	MC5515X10X20	GG308-NP10-20	133
4229X24	FF9767T24-S	56	MC5515X10X22	GG308-NP10-22	133
4924X4	FF9768-04S	56	MC5515X12X22	GG308-NP12-22	133
4924X6	FF9768-06S	56	MC5515X12X27	GG308-NP12-27	133
4924X8	FF9768-08S	56	MC5515X16X33	GG308-NP16-33	133
4924X10	FF9768-10S	56	MC5405X4X4	GG310-NP04-04	138
4924X12	FF9768-12S	56	MC5405X5X4	GG310-NP05-04	138
4924X16	FF9768-16S	56	MC5405X6X4	GG310-NP06-04	138
4924X20	FF9768-20S	56	MC5405X6X6	GG310-NP06-06	138
4924X24	FF9768-24S	56	MC5405X6X8	GG310-NP06-08	138
4129X4	FF9863-04S	56	MC5405X8X6	GG310-NP08-06	138
4129X6	FF9863-06S	56	MC5405X8X8	GG310-NP08-08	138
4129X8	FF9863-08S	56	MC5405X10X12	GG310-NP10-12	138
4129X10	FF9863-10S	56	MC5405X12X12	GG310-NP12-12	138
4129X12	FF9863-12S	56	MC5405X16X16	GG310-NP16-16	138
4129X16	FF9863-16S	56	MC5405X20X20	GG310-NP20-20	138
4129X20	FF9863-20S	56	ML7105X6	WAL039842	
4129X24	FF9863-24S	56	ML7105X8	WAL039843	
MB5315X4X2	GG106-NP04-02	136	ML7105X10	WAL039844	
MB5315X4X4	GG106-NP04-04	136	ML7105X12	WAL039845	
MB5315X4X6	GG106-NP04-06	136	ML7105X15	WAL039846	
MB5315X4X8	GG106-NP04-08	136	ML7105X18	WAL039847	
MB5315X5X4	GG106-NP05-04	136	ML7105X22	WAL039848	
MB5315X6X4	GG106-NP06-04	136	ML7105X28	WAL039849	
MB5315X6X6	GG106-NP06-06	136	MH7105X6	WAL039852	
MB5315X6X8	GG106-NP06-08	136	MH7105X8	WAL039853	
MB5315X8X4	GG106-NP08-04	136	MH7105X10	WAL039854	
MB5315X8X6	GG106-NP08-06	136	MH7105X12	WAL039855	
MB5315X8X8	GG106-NP08-08	136	MH7105X14	WAL039856	
MB5315X8X12	GG106-NP08-12	136	MH7105X16	WAL039857	
MB5315X10X6	GG106-NP10-06	136	MH7105X20	WAL039858	
MB5315X10X8	GG106-NP10-08	136	MH7105X25	WAL039859	
MB5315X10X12	GG106-NP10-12	136	MH7105X30	WAL039860	
MB5315X12X8	GG106-NP12-08	136	MH7105X38	WAL039861	
MB5315X12X12	GG106-NP12-12	136	7165X6MM	WAL372404	
MB5315X12X16	GG106-NP12-16	136	7165X8MM	WAL372405	
MB5315X16X12	GG106-NP16-12	136	7165X10MM	WAL372406	
MB5315X16X16	GG106-NP16-16	136	7165X12MM	WAL372407	
MB5315X16X20	GG106-NP16-20	136	7165X15MM	WAL372408	
MB5315X20X20	GG106-NP20-20	136	7165X18MM	WAL372409	
MC5315X4X10	GG108-NP04-10	133	7165X22MM	WAL372410	
MC5315X4X12	GG108-NP04-12	133	7165X28MM	WAL372411	
MC5315X4X14	GG108-NP04-14	133	7165X14MM	WAL372414	
MC5315X6X14	GG108-NP06-14	133	7165X16MM	WAL372415	
MC5315X6X16	GG108-NP06-16	133	7165X20MM	WAL372416	
MC5315X8X18	GG108-NP08-18	133	7165X25MM	WAL372417	
MC5315X8X22	GG108-NP08-22	133	7165X30MM	WAL372418	

Please reference
Walterscheid
master catalog
for metric
tube fitting
components:
Literature
number
E-MEFI-
MC002-E1.

Notes

Eaton
Hydraulics Group USA
14615 Lone Oak Road
Eden Prairie, MN 55344
USA
Tel: 952-937-9800
Fax: 952-294-7722
www.eaton.com/hydraulics

Eaton
Hydraulics Group Europe
Route de la Longeraie 7
1110 Morges
Switzerland
Tel: +41 (0) 21 811 4600
Fax: +41 (0) 21 811 4601

Eaton
Hydraulics Group Asia Pacific
Eaton Building
4th Floor, No.7 Lane280 Linhong Rd.
Changning District
Shanghai 200335
China
Tel: (+86 21) 5200 0099
Fax: (+86 21) 2230 7240



© 2020 Eaton
All Rights Reserved
Printed in USA
Document No. E-MEAD-CC002-E1
November 2020

Eaton is a registered trademark.
All other trademarks are property
of their respective owners.