



**Miller**<sup>®</sup>

The Power of Blue<sup>®</sup>



**WE BUILD**<sup>™</sup>

**2021 FULL-LINE CATALOG**  
**MILLERWELDS.COM**

**TOGETHER**

# WE BUILD™ TOGETHER

Together we build, repair and create to make this a better, brighter world. We power the engines of commerce and energy; fuel the wheels of transportation and industry; and construct the framework of championships and dreams.

Whether you're just starting out in the trades, a seasoned veteran or somewhere in between — we have innovative products, project inspiration and a welding community that can bring out your best. Together, **WE BUILD™**.

## ABOUT THE FRONT COVER



### Phillip Welch (far left)

is a Naval veteran who recently graduated from Tulsa Welding School & Technology Center and is now working on US Navy F/A-18 fighter jets as an aircraft mechanic in Maryland with DynCorp International. He's been welding since he was 15 years old — his father who is also a welder, laid out a blueprint for success in life. Phillip loves to weld and believes 'there is no better person to be than like your dad'.

### Tony Beets (left)

is known as the 'king of the Klondike' and 'the Viking' and most recognized for his role in Discovery Channel's hit series 'Gold Rush'. The veteran gold miner from Canada's Yukon Territory is a determined character for whom failure is not an option. A critical part of his success is choosing the right equipment to keep his multiple mining operations up and running. Tony Beets has been a Miller user for decades.

### Kayla Smith (center)

has been a welder for four years. She is passionate about being great at her work and learning more about the trade. No one in her immediate family has been a welder before, but she found a true passion in the job from the moment she started. Kayla hopes one day to be a light to others to explore the opportunity to weld with Miller® products.

### Frank Pagano (right)

is the winner of our 2017 #whyiweldcontest and the owner of PAG Welding and Fabrication. His company motto is "Make Metal Memorable" and creating with metal has been a driving force in Frank's life ever since he learned to weld. Each project is another opportunity to set goals, achieve them and then set new ones. Whether he's welding for himself or for someone else, Frank is inspired to always become better at his craft.

### Nick Bezates (far right)

is the owner of Bezates Construction in Oregon. He has been in the welding fabrication industry about 20 years and has a construction engineering management degree from Oregon State. Growing up with a father in construction, Nick is passionate about educating kids on career opportunities in the trades. He specializes in welding service, fabrication, and excavation in both pipeline and structural steel construction and repair.

For pricing or to find your local distributor, visit us on the web or give us a call.

MillerWelds.com



1-800-4-A-Miller (1-800-426-4553)



# NEW FROM BLUE

**39** Multimatic®  
235



**51** CST™ 282 and  
CST™ 282 Rack



**55** Syncrowave®  
400



**76** Bobcat™ 260  
with Remote Start/Stop



**80** Wireless Interface  
Control



**92** ArcReach®  
Heater



**SHOP WITH  
EXPERT ADVICE  
AND ATTENTION**

Visit your local Miller distributor for in-depth knowledge and one-on-one assistance in product selection.

[MillerWelds.com/wheretobuy](http://MillerWelds.com/wheretobuy)

**SHOP WITH SPEED  
AND CONVENIENCE**

Visit [MillerWelds.com](http://MillerWelds.com) for a fast and easy way to buy welding products for your home or shop.

**113** Face Shield  
Series



# BENEFITS OF BLUE

# TECHNOLOGIES AND INNOVATIONS

Miller is committed to bringing forward-thinking technologies and solutions to the welding industry. We listen to your challenges and constantly seek to improve our products and services to better address them.

## EASE OF USE

### ArcConnect™

Next generation communication that utilizes high-speed signals to improve weld performance and allow point-of-use controls to be located at the feeder. Found on the Deltaweld® Systems (pg 12).

### AUTO-LINE™ TECHNOLOGY

Allows for any input voltage hookup with no manual linking. Provides convenience in any job setting and is ideal for dirty or unreliable power. Found on the following products:

#### MIG

Millermatic® 255 (pg 9)  
AlumaPower™ 350 (pg 11)  
Invision™ 352 (pg 14)  
Continuum™ (pg 15)  
Auto-Continuum™ (pg 16)

#### Multiprocess

Multimatic® 255 (pg 40)  
Maxstar® (pg 41)  
Dynasty® (pg 41)  
XMT® 350 (pg 42–45)

#### Stick

Maxstar® (pg 49–50)  
CST™ 282 (pg 51)  
**TIG**  
Maxstar® (pg 53/56–58)  
Syncrowave® 210 (pg 54)  
Dynasty® (pg 56–58)

#### Plasma cutters

Spectrum® (pg 95)

### AutoSense™

Reduces issues related to setting helmet sensitivity by allowing welder to push and hold the AutoSense button to automatically set the helmet sensitivity for their environment. Found on Digital Infinity™ and Digital Elite™ welding helmets (pg 111).

### Auto-Set™

Provides speed, convenience and confidence of preset controls and eliminates guesswork when setting weld parameters. Variations of this technology include **Advanced Auto-Set** and **Auto-Set Elite**. Found on the following products:

#### MIG

Millermatic® 141/211 (pg 7)  
Millermatic® 255 (pg 9)

#### Multiprocess

Multimatic® (pg 37–40)

#### TIG

Syncrowave® 210 (pg 54)

### MVP™ plugs and adapters

Allows connection to common 120- or 240-volt receptacles without the use of tools — just choose the plug/adaptor that fits the receptacle. Found on the following products:

#### MIG

Millermatic® 211 (pg 7)

#### Multiprocess

Multimatic® 200/215 (pg 37)  
Multimatic® 220 AC/DC (pg 38)

#### Stick

Thunderbolt® 160 (pg 49)

#### TIG

Diversion™ (pg 53)  
Syncrowave® 210 (pg 54)

#### Engine drives

Fusion (pg 73)

#### Plasma cutters

Spectrum® 375/625 (pg 94)



### POWER SHIFT

Provides single-phase stick weld capability with the engine shut off by plugging into 120- or 240-volt wall power. Ideal for indoor or noise-sensitive environments. Found on the Fusion engine drive (pg 73).

### Pro-Set™

Provides speed, convenience and confidence of preset controls and eliminates guesswork when setting TIG or stick weld parameters. Found on the following products:

#### Multiprocess

Multimatic® 220 AC/DC (pg 38)  
Multimatic® 235 (pg 39)  
Maxstar® (pg 41)  
Dynasty® (pg 41)

#### TIG

Syncrowave® (pg 54–55)  
Maxstar® (except 161) (pg 56–58)  
Dynasty® (pg 56–58)

### QuickTech™

Provides easy setup and process changing on the Multimatic® 220 AC/DC multiprocess welder (pg 38).

- *Automatically* determines polarity. Work is always connected to the bottom right receptacle. MIG gun and TIG torch can stay connected at the same time.
- *Automatically* switches to the right process. Just hit trigger or foot control and the machine automatically changes, eliminating the need to manually change processes.
- *Automatically* recalls settings from the last process used.

### Remote start/stop

Allows you to easily turn your Bobcat™ welder/generator on and off remotely so it only runs when you need it. Get more out of each tank, extend time between maintenance and work without the hassle of walking back to your machine. Found on the Bobcat™ 225 and 260 (non-LP) engine drives (pg 76).



### X-Mode™

Electromagnetically senses the weld to reduce sunlight interference and continuously detects the arc even if sensors are blocked. Found on the T94™, Digital Infinity™, Digital Elite™ and Classic VSi™ welding helmets (pg 110–111).



## OPTIMIZATION AND PERFORMANCE

### Advanced welding processes

**Versa-Pulse™** is a fast, low-heat, low-spatter process designed for materials up to 1/4 inch and is great for gap filling.

**Accu-Pulse®** is better for out-of-position welds, provides higher deposition rates and has the most adaptive arc on 16 gauge and thicker materials.

**RMD® (Regulated Metal Deposition)** is a modified-short-circuit process with the lowest heat and limited travel speed. Designed to fill gaps in thin-material applications, it provides a higher quality root pass, a calm stable arc and less spatter.

Advanced welding processes are found on the following products:

#### MIG

Deltaweld® 350/500 with Intelx™ Pro feeder (Accu-Pulse only) (pg 12)  
Continuum™ Systems (pg 15)  
Auto-Continuum™ Systems (pg 16)

#### Multiprocess (RMD only)

XMT® 350 FieldPro models (pg 44) with ArcReach Smart Feeder  
PipeWorx 400 System (pg 48)

#### Engine drives (RMD only)

Trailblazer® 325 ArcReach models (pg 78) w/ArcReach Smart Feeder  
Big Blue® ArcReach models (pg 81–84) with ArcReach Smart Feeder

### Augmented reality welding

Training solution that builds a larger, more skilled welding workforce and quickly helps correct errors, reinforces proper welding practices and accelerates skill advancement. Found on the AugmentedArc™ augmented reality welding system (pg 117).

### ClearLight™ Lens Technology

Provides high-definition optics for precision arc recognition. Found on T94™, Digital Infinity™, Digital Elite™, Digital Performance™ and Classic Series VS welding helmets (pg 110–111).

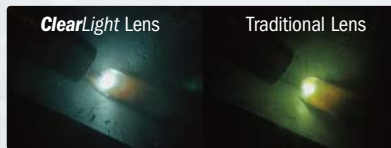

Automatically adjusts the amount of current required to clear a short. Delivers a smoother, more consistent arc that can be tailored to match the application, material, fit-up and welder technique. Found on Trailblazer® 325 (pg 78) and Big Blue® (pg 81–84) engine drives.

### Insight Welding Intelligence™

**Insight Core™** is an easy-to-use welding information solution that gives visibility into your operation so you can improve productivity.

**Insight Centerpoint™** is a real-time welder feedback solution that provides guidance and control within the weld cell to ensure consistent weld quality.

For more information, see pages 69–71. Insight Welding Intelligence is found on the following products:

#### MIG (Insight Core standard)

Deltaweld® 350/500 (pg 12)  
Continuum™ (pg 15)  
Auto-Continuum™ (pg 16)

#### MIG (Insight Centerpoint optional)

Continuum™ (pg 15)  
Auto-Continuum™ (pg 16)

*Note: Insight Core is compatible with many 14-pin compliant Miller® power sources (see chart at MillerWelds.com/insight) using an Insight Core 14-pin module or ALL power sources using an ArcAgent for Insight Core. Insight Centerpoint is compatible with ALL power sources using an ArcAgent Manual or ArcAgent Auto.*

## PRODUCTIVITY

**ArcReach®** Allows operators to adjust welding parameters right at the weld joint without a control cord, using the wire feeder (pg 18/47) or remote (pg 47) — maximizing arc-on time and impacting the bottom line. Found on the following products:

#### Multiprocess

XMT® 350 FieldPro™ models (pg 44)  
XMT® 450 CC/CV ArcReach (pg 45)  
Dimension™ 650 ArcReach (pg 46)

#### Engine drives

Trailblazer® 325 ArcReach models (pg 78)  
Big Blue® ArcReach models (pg 81–84)

### Auto-Speed™

Automatically adjusts engine speed to meet demands so the engine never works harder than necessary. Reduces fuel consumption and noise levels on the Bobcat™ 200 Air Pak™ (pg 75) and Trailblazer® 325 (pg 78) engine drives.

### Excel™ power

Provides 2,400 watts (20 A) of 120-volt power at all engine speeds, including idle. Reduces fuel consumption and noise levels on select models of the Trailblazer® 325 engine drive (pg 78).

### Fan-On-Demand™

Fan only operates when needed to reduce noise, energy use and amount of contaminants pulled through the machine. Found on various MIG, multiprocess, stick, TIG and plasma cutter products.

### InfoTrack™

Data monitoring technology tracks arc time and features a clock. Version 2.0 adds arc count. Found on the T94™ and Digital Infinity™ welding helmets (pg 110–111).

### WIRELESS INTERFACE CONTROL

Get full control of your welder/generator in the palm of your hand. Change welding processes, adjust parameters, select and save preset programs, turn the machine on/off, get service reminders and more from wherever you are on the jobsite. Extend time between fill ups and maintenance intervals while eliminating the need to go back to your machine to make adjustments. Found on select models of the Trailblazer® 325 (pg 78) and Big Blue® (pg 81–84) engine drives.

### ZoneFlow™ technology

Extended-capture weld fume extraction technology extends the capture zone up to five feet deep and four feet wide (versus up to 18 inches from conventional source capture extractors). The increased capture zone reduces arm interactions so operators can keep welding, increasing arc-on time and productivity. Found on the FILTAIR® Capture 5, and select FILTAIR® SWX and 4000–12000 models (pg 104–106).





## Product Guide

|                | Page                           | Class | MIG | Pulsed MIG | Flux-cored* | CAC-A | Portability                                 | Weldable Metals            | Welding Output Range | Special Features  | Typical Applications   |
|----------------|--------------------------------|-------|-----|------------|-------------|-------|---|----------------------------|----------------------|---|--|
| 1-Phase        | Millermatic® 141               | 7     | ●   | ●          | ●           |       | Handles, optional running gear              | Steel, stainless, aluminum | 30-140 A             | All-in-one, 120 V input, Auto-Set™, Smooth-Start™   | Up to 3/16 in. using self-shielded wire maintenance/repair, auto body, hobby               |
|                | Millermatic® 211               | 7     | ●   | ●          | ●           |       |   |                            | 30-230 A             | All-in-one, 120 or 240 V input, Auto-Set™, Smooth-Start™  | Up to 3/8 in. maintenance/repair, auto body, hobby   |
|                | Millermatic® 252               | 8     | ●   | ●          | ●           |       | Installed running gear                      | Steel, stainless, aluminum | 30-300 A             | All-in-one, standard timers menu, Fan-On-Demand™, connects to standard MIG gun, push-pull gun or spool gun                            | Up to 1/2 in. industrial production/fabrication, farm                                      |
|                | Millermatic® 255               | 9     | ●   | ●          | ●           |       | Handles, optional running gear              | Steel, stainless, aluminum | 20-350 A             | All-in-one, Auto-Set™ stores up to four programs, connects to standard MIG gun, push-pull gun or spool gun                            | Up to 1/2 in. industrial production/fabrication, pulsed MIG ideal for thin gauge aluminum  |
| 1- and 3-Phase | Millermatic® 350P              | 10    | ●   | ●          | ●           |       | Installed running gear                      | Steel, stainless, aluminum | 25-400 A             | All-in-one, connects to standard MIG gun, push-pull gun or spool gun  | Up to 1/2 in. industrial production/fabrication, pulsed MIG ideal for thin gauge aluminum  |
|                | Millermatic® 350P Aluminum     | 10    | ●   | ●          | ●           |       |   | Aluminum                   | 25-400 A             | All-in-one, optimized for feeding aluminum wire only using a push-pull gun or spool gun   | Up to 1/2 in. industrial aluminum production/fab, pulsed MIG ideal for thin gauge aluminum |
|                | AlumaFeed™ 350 Aluminum System | 11    | ●   | ●          | ●           |       | Handles, optional cart, MIGRunner™          | Aluminum                   | 5-425 A<br>10-38 V   | Profile Pulse™ lightweight feeder can be up to 100 feet from power source   | Heavy industrial aluminum production/fabrication, truck trailer, shipbuilding              |
|                | Invision™ 352 MPa Plus System  | 14    | ●   | ●          | ●           | 1/4"  |   | Most metals                | 5-425 A<br>10-38 V   | Push-pull gun capability, optimized with 74 MPa Plus wire feeder  | Manufacturing and production   |
| 3-Phase        | AlumaFeed™ 450 Aluminum System | 11    | ●   | ●          | ●           |       | Handles, optional cart, MIGRunner™          | Aluminum                   | 15-600 A<br>10-38 V  | Profile Pulse™ lightweight feeder can be up to 100 feet from power source   | Heavy industrial aluminum production/fabrication, truck trailer, shipbuilding              |
|                | Invision™ 450 MPa Plus System  | 14    | ●   | ●          | ●           | 5/16" |   | Most metals                | 15-600 A<br>10-38 V  | Push-pull gun capability, optimized with 74 MPa Plus wire feeder  | Manufacturing and production   |
|                | Deltaweld™ 350 Systems         | 12    | ●   | ●          | ●           |       | Lift eye, optional running gear, MIGRunner™ | Steel, stainless           | 20-400 A<br>10-38 V  | Special arc control feature when paired with Intelx™ feeders, Accu-Pulse® MIG welding with Intelx Pro feeders; optional Insight Core™ | Medium-to-large manufacturing and fabrication  |
|                | Deltaweld™ 500 Systems         | 12    | ●   | ●          | ●           | 3/8"  |   |                            | 30-650 A<br>10-44 V  | Special arc control feature when paired with Intelx™ feeders, Accu-Pulse® MIG welding with Intelx Pro feeders; optional Insight Core™ | Medium-to-large manufacturing and fabrication  |
|                | Continuum™ 350                 | 15    | ●   | ●          | ●           | 1/4"  | Lift eye, optional running gear, MIGRunner™ | Most metals                | 20-400 A<br>10-44 V  | Advanced arc performance, Insight Core™; optional Insight Centerpoint™  | Mid- to high-volume manufacturing  |
|                | Continuum™ 500                 | 15    | ●   | ●          | ●           | 3/8"  |   |                            | 20-600 A<br>10-44 V  | Advanced arc performance, Insight Core™; optional Insight Centerpoint™  | Mid- to high-volume manufacturing  |
|                | Auto-Continuum™ 350            | 16    | ●   | ●          | ●           |       | Lift eye                                    | Most metals                | 20-400 A<br>10-44 V  | Available for EtherNet/IP™, DeviceNet and analog protocol, Insight Core™; optional Insight Centerpoint™                               | Fixed and flexible automation  |
|                | Auto-Continuum™ 500            | 16    | ●   | ●          | ●           |       |   |                            | 20-600 A<br>10-44 V  | Available for EtherNet/IP™, DeviceNet and analog protocol, Insight Core™; optional Insight Centerpoint™                               | Fixed and flexible automation  |

### Product Key

Class: ● Light industrial ● Industrial ● Heavy industrial Capability: ● Designed for this process ● Capable of this process  
 Improved! products appear in blue type. \*If using self-shielded wire on a CC/CV machine, use CV weld output.

# Millermatic® 141 and 211

See literature DC/12.42 (141) and DC/12.58 (211)

Light industrial • **CV DC 1** Phase

## Processes

- MIG (GMAW) ▪ Flux-cored (FCAW)

## Comes complete with

- 10 ft. (3 m) 100-amp MDX™-100 MIG gun with AccuLock™ MDX™ consumables
- 10 ft. (3 m) work cable with clamp
- 6.5 ft. (2 m) power cord with plug (Millermatic 141) **OR** 6.5 ft. (2 m) power cord with MVP plugs for 120 V and 240 V (Millermatic 211)
- Quick Select™ drive roll for .024 in. (0.6 mm) or .030/.035 in. (0.8/0.9 mm) solid wire, and .030/.035 in. (0.8/0.9 mm) flux-cored wire



- Flow gauge regulator and gas hose for argon or AR/CO<sub>2</sub> mix, two .030 in. contact tips, Hobart® spool of .030 in. solid wire, hook-and-loop cord wraps and material thickness gauge (229895)

## Most popular accessories

- Spoolmate™ 100 300371 (pg 27)
- Spoolmate™ 150 301272 (pg 27) (for Millermatic 211 only)



- Running Gear/Cylinder Rack 301239 (pg 118)
- Protective Cover 301262 (pg 121)
- V-Knurled Drive Roll 202926

Visit [MillerWelds.com](http://MillerWelds.com) or your distributor for other Miller® options and accessories.



Millermatic 211



Multi-voltage plug (MVP™) allows connection to common 120- and 240-volt power receptacles without the use of any tools – simply choose the plug that fits the receptacle and connect to the power cord.

Millermatic 141

## Mild Steel Welding Capability

|       |                   |                  |  |
|-------|-------------------|------------------|--|
|       |                   | 3/8 in. (9.5 mm) |  |
| Max.  | 3/16 in. (4.8 mm) |                  |  |
| Model | 141               | 211              |  |
| Min.  | 24 ga. (0.6 mm)   | 24 ga. (0.6 mm)  |  |

## Aluminum Welding Capability

|       |                 |                  |  |
|-------|-----------------|------------------|--|
|       |                 | 3/8 in. (9.5 mm) |  |
| Max.  | 14 ga. (1.9 mm) |                  |  |
| Model | 141             | 211              |  |
| Min.  | 18 ga. (1.2 mm) | 18 ga. (1.2 mm)  |  |

Aluminum welding with the Millermatic 141 uses optional Spoolmate 100 spool gun and 4043 series aluminum wire. Aluminum welding with the Millermatic 211 uses optional Spoolmate 100 spool gun with 4043 aluminum series wire **OR** optional Spoolmate 150 spool gun with 4000 or 5000 series aluminum wire.

## Recommended aluminum solution

Spoolmate 100 (page 27) with both Millermatic models **OR** Spoolmate 150 (page 27) with Millermatic 211.



**Auto-Set™** automatically provides the right settings to weld mild steel while **infinite voltage control** allows the flexibility to manually set your own parameters. Millermatic 211 model provides additional capabilities.



- Set the wire diameter (141: .024/.030 in.) (211: .024/.030/.035 in.), a blue light shows Auto-Set is activated
- Dial in the thickness of material you are welding
- Start welding with the exact parameters you need!

**Angled cast-aluminum drive system** with calibrated tension knob creates consistent feeding and easy setup.

**Quick Select™ drive roll** makes setup quicker by offering three grooves – two for different size solid wire and a third for flux-cored wire.

**Auto Spool Gun Detect™** automatically detects when a MIG gun or spool gun is connected, eliminating the need for a switch.

**Smooth-Start™** provides a smooth, spatter-free start.

**Thermal overload protection** shuts down unit and activates the **over temperature light** if airflow is blocked or duty cycle is exceeded. Automatically resets when unit cools.

**Uses 4- or 8-inch (102 or 203 mm) spools.**

## Millermatic 211 model additional features

**Advanced Auto-Set™** includes five different wire/gas combinations and .024-, .030- and .035-inch wire capabilities.

**Inverter technology** combines best-in-class arc characteristics with the portability of a 38-pound machine. The arc is extremely forgiving to variations in arc length and travel speeds.

**Fan-On-Demand™** cooling system only operates when needed, reducing power consumption and keeping internal components cleaner.

| Model/Stock Number  | Input Power | Amperage Range | Rated Output                      | Amps Input at Rated Output, 50/60 Hz |       |     |      | Wire Feed Speed              | Wire Type and Diameter Capacity  | Power Source Dimensions                       | Power Source Net Weight |
|---|-------------|----------------|-----------------------------------|--------------------------------------|-------|-----|------|------------------------------|--|---|-------------------------|
|   |             |                |                                   | 120 V                                | 240 V | KVA | KW   |                              |  |   |                         |
| Millermatic 141 (907612) (951601) with running gear/cylinder rack | 120 V       | 30-140         | 90 A at 18.5 VDC, 20% duty cycle  | 20                                   | –     | 3.0 | 2.45 | 15-360 ipm (0.4-9.1 m/min.)  | <b>Solid steel</b> .023-.030 in. (0.6-0.8 mm)<br><b>Stainless</b> .023-.030 in. (0.6-0.8 mm)<br><b>Flux-cored</b> .030-.035 in. (0.8-0.9 mm) | H: 12.5 in. (318 mm)<br>W: 11.25 in. (286 mm) | 51 lb. (23.1 kg)        |
|   | 240 V       | 30-230         | 150 A at 21.5 VDC, 40% duty cycle | –                                    | 16.6  | 4.0 | 4.0  |                              |  | D: 20.5 in. (521 mm)                          | 38 lb. (17.2 kg)        |
| Millermatic 211 (907614) (951603) with running gear/cylinder rack | 120 V       | 30-130         | 115 A at 19.8 VDC, 20% duty cycle | 24.3                                 | –     | 2.9 | 2.9  | 60-600 ipm (1.5-15.2 m/min.) | <b>Solid steel</b> .023-.035 in. (0.6-0.9 mm)<br><b>Stainless</b> .023-.035 in. (0.6-0.9 mm)<br><b>Flux-cored</b> .030-.045 in. (0.8-1.2 mm) |   |                         |
|   | 240 V       | 30-230         | 150 A at 21.5 VDC, 40% duty cycle | –                                    | 16.6  | 4.0 | 4.0  |                              |  |   |                         |

# Millermatic® 252

See literature DC/12.49



**Recommended aluminum solution**  
Spoolmatic 15A **OR** 30A  
(page 28).

### Welding Capability

|                      |                      |
|----------------------|----------------------|
| Max. 1/2 in. (13 mm) |                      |
| Mild Steel           | Aluminum             |
| Min. 22 ga. (0.8 mm) | Min. 14 ga. (1.9 mm) |

Aluminum welding uses optional Spoolmatic 15A **OR** 30A spool gun.

**Infinite voltage control with self-calibrating digital meters** that permit presetting of voltage and wire feed speed. Ensures precise parameters and accuracy.

**EXCLUSIVE! Auto-Gun Detect™** automatically adjusts voltage, wire speed and timers for faster switching between MIG, push-pull and spool guns.

**Integrated digital timers** come complete with presettable preflow/postflow, bumback, spot and delay (stitch) timers. Independent timers for MIG and spool gun.

**Fan-On-Demand™** cooling system only operates when needed, reducing power consumption and keeping internal components cleaner.

**Superior aluminum MIG welding with direct connection** of optional Spoolmate™ 200 and Spoolmatic® spool guns or XR™ push-pull guns. No extra module to buy or install.

**Heavy-duty aluminum two-drive-roll system.**

**Uses 4-, 8- or 12-inch (102, 203 or 305 mm) spools.**

**Industrial** ● **CV DC 1**  
Phase

### Processes

- MIG (GMAW) ▪ Flux-cored (FCAW)

### Comes complete with

- 15 ft. (4.5 m), 250-amp MDX™-250 MIG gun with AccuLock™ MDX™ consumables
- 10 ft. (3 m) work cable with clamp
- 10 ft. (3 m) industrial power cord (and plug on 200/230 V model)
- Factory-installed gas solenoid
- Flow gauge regulator and gas hose for argon or AR/CO<sub>2</sub> mix
- Factory-installed lowered running gear/cylinder rack
- .030/.035 in. reversible dual-groove drive rolls
- Extra contact tips

### Most popular accessories

- Spoolmate™ 200 Spool Gun (pg 27)
- Spoolmatic® Spool Gun (pg 28) (non-Pro gun only)
- XR™ Air-Cooled Push-Pull Guns (pg 29)
- Dual EZ-Change™ Low Cylinder Rack 300337 (pg 118)
- Elevated Gun and Cable Rack 300335 (pg 118)
- Protective Cover 195142 (pg 121)
- 230-Volt Extension Cord 770644

Visit [MillerWelds.com](http://MillerWelds.com) or your distributor for other Miller® options and accessories.

\*With Spoolmatic 30A, regulator and dual cylinder rack.

\*\*While idling.

| Stock Number                                      | Amperage Range | Rated Output                      | Amps Input at Rated Output, 60 Hz |       |       |       |       |        | Wire Feed Speed | Wire Type and Diameter Capacity | Dimensions   | Net Weight  |                    |
|---|----------------|-----------------------------------|-----------------------------------|-------|-------|-------|-------|--------|-----------------|---------------------------------|--|---|--------------------|
|   |                |                                   | 200 V                             | 230 V | 240 V | 460 V | 575 V | KVA    |                 |                                 |  |   | KW                 |
| (907321) 208/240 V<br>(951066*) 208/240 V         | 30-300         | 200 A at 24 VDC, 60% duty cycle   | 57.0                              | —     | 50.8  | —     | —     | 11.4   | 7.1             | 50-700 ipm<br>(1.3-17.8 m/min.) | Solid steel<br>.023-.045 in. (0.6-1.2 mm)<br>Stainless<br>.023-.045 in. (0.6-1.2 mm)<br>Flux-cored<br>.030-.045 in. (0.8-1.2 mm) | H: 30 in.<br>(762 mm)<br>W: 19 in.<br>(483 mm)<br>D: 40 in.<br>(1,016 mm) | 205 lb.<br>(93 kg) |
|   |                | 250 A at 26.5 VDC, 40% duty cycle | 64.2                              | —     | 56.4  | —     | —     | 12.6   | 9.4             |                                 |  |   |                    |
| (907322) 230/460/575 V<br>(951065*) 230/460/575 V |                | 200 A at 24 VDC, 60% duty cycle   | —                                 | 46    | —     | 23    | 18    | 9.8    | 7.5             |                                 |  |   |                    |
|   |                | 250 A at 26.5 VDC, 40% duty cycle | —                                 | 2**   | —     | 1**   | 0.8** | 0.46** | 0.13**          |                                 |  |   |                    |

**Miller recommends**



### Innovation

Focused on optimizing quality, ease-of-use and cost

### Collaboration

Partnering to meet customer needs

### Trusted source

Deep product and application expertise to deliver success

Visit [HobartBrothers.com](http://HobartBrothers.com) for more information.

**More than just filler metal... SOLUTIONS for your business.**

# Millermatic® 255

See literature DC/12.8



Millermatic 255 with running gear package shown.

### Welding Capability

|                      |                      |
|----------------------|----------------------|
| Max. 1/2 in. (13 mm) | Max. 1/2 in. (13 mm) |
| Mild Steel           | Aluminum             |
| Min. 24 ga. (0.6 mm) | Min. 18 ga. (1.2 mm) |

Aluminum welding uses optional XR-Aluma-Pro push-pull gun.

### Recommended aluminum solution

XR-Aluma-Pro™ push-pull gun (page 29).



**NEW! Pulsed MIG programs for silicon bronze and 98 argon/2 CO<sub>2</sub> stainless steel.**



**Easy-to-understand interface with 7-inch color LCD display** ensures proper machine setup and parameter selection, reducing setup time and increasing weld time.

- Quick-access Auto-Set and pulse mode backlit buttons across the top illuminate when active
- Soft-key buttons below the display change function depending on which screen is displayed – makes setup or change quick, easy and intuitive
- Large text for easier readability
- Intuitive connection setup images
- Full troubleshooting descriptions versus help errors and look up codes

**AUTO-LINE TECHNOLOGY** Allows for any input voltage hookup (208–240 V, single-phase) with no manual linking, providing convenience in any job setting. Ideal solution for dirty or unreliable power.

**Built-in pulsed MIG programs.** All programmed information is restored after each power up – aluminum/steel/stainless steel.

**Auto-Set™ Elite** offers predefined weld settings to increase ease of use and ensure that the job is done right for operators of all skill levels.

- Available for MIG and pulsed MIG processes with the ability to fine-tune your settings
- Set weld parameters by selecting wire and gas type, wire diameter and material thickness

**Program mode** allows easy save and recall of favorite weld settings. Delivers more productivity and consistent quality while minimizing supervisor intervention.

**EXCLUSIVE! Auto-Gun Detect™** automatically adjusts voltage, wire speed and timers for faster switching between MIG, push-pull and spool guns.

**Heavy-duty aluminum two-drive-roll system.**

**Uses 4-, 8- or 12-inch (102, 203 or 305 mm) spools.**

**Fan-On-Demand™** cooling system only operates when needed, reducing power consumption and keeping internal components cleaner.

Industrial ● CV DC 1 Phase

### Processes

- MIG (GMAW) ▪ Flux-cored (FCAW)
- Pulsed MIG (GMAW-P)

### Comes complete with

- 15 ft. (4.5 m) 250-amp MDX™-250 MIG gun with AccuLock™ S consumables
- 10 ft. (3 m) work cable with clamp
- 10 ft. (3 m) industrial power cord
- Factory-installed gas solenoid
- Flow gauge regulator and gas hose for argon or AR/CO<sub>2</sub> mix
- Chain to secure gas cylinder
- .035/.045 in. reversible V-groove drive rolls
- Extra contact tips and material thickness gauge (229895)

### Most popular accessories

- MDX™-250 EZ-Select™ MIG Gun 1770047 (pg 24)
  - Spoolmatic® Spool Gun (pg 28) (non-Pro gun only)
  - XR-Aluma-Pro™ Air-Cooled Push-Pull Guns (pg 29)
  - EZ-Latch™ Single Cylinder Running Gear 301449 (pg 118)
  - EZ-Latch™ Dual Cylinder Rack with Elevated Gun and Cable Rack 301481
- Converts an EZ-Latch™ Single Cylinder Running Gear into a Dual Cylinder Rack Running Gear as seen below



- **EZ-Latch™ Dual Cylinder Rack Running Gear** 951769 (pg 118)
- Protective Cover 301521 (pg 121)

Visit [MillerWelds.com](http://MillerWelds.com) or your distributor for other Miller® options and accessories.

| Stock Number<br>(907734) 208–240 V<br>(951766) 208–240 V with single cylinder running gear | Amperage Range | Rated Output                      | Amps Input at Rated Output, 50/60 Hz |       |     |     | Wire Feed Speed            | Wire Type and Diameter Capacity  | Power Source Dimensions   | Power Source Net Weight |
|--|----------------|-----------------------------------|--------------------------------------|-------|-----|-----|----------------------------|--|---|-------------------------|
|  |                |                                   | 208 V                                | 240 V | KVA | KW  |                            |  |   |                         |
|  | 20–350         | 230 A at 25.5 VDC, 60% duty cycle | 44.0                                 | 39.5  | 9.5 | 7.2 | 50–800 ipm (1.3–20 m/min.) | <b>Solid steel</b> .023–.045 in. (0.6–1.2 mm)<br><b>Stainless</b> .023–.045 in. (0.6–1.2 mm)<br><b>Aluminum</b> .035–.047 in. (0.9–1.2 mm)<br><b>Flux-cored</b> .030–.045 in. (0.8–1.2 mm) | H: 19.24 in. (489 mm)<br>W: 13.75 in. (349 mm)<br>D: 24.25 in. (616 mm) | 84 lb. (38 kg)          |

# Millermatic® 350P

See literature DC/12.51



**Recommended aluminum solution**  
XR-Aluma-Pro™ push-pull gun (page 29).

## Welding Capability

|                      |                      |
|----------------------|----------------------|
| Max. 1/2 in. (13 mm) | Max. 1/2 in. (13 mm) |
| Mild Steel           | Aluminum             |
| Min. 24 ga. (0.6 mm) | Min. 18 ga. (1.2 mm) |

Aluminum welding uses optional XR-Aluma-Pro push-pull gun.

**Built-in pulsed MIG programs.** All programmed information is restored after each power up – aluminum/steel/stainless steel/metal-cored.

**Infinite voltage control with self-calibrating digital meters** that permit presetting of voltage and wire feed speed. Ensures precise parameters and accuracy.

**EXCLUSIVE! Auto-Gun Detect™** automatically adjusts voltage, wire speed and timers for faster switching between MIG, push-pull and spool guns.

**Integrated digital timers** come complete with presettable preflow/postflow and spot timers. Independent timers for MIG and push-pull guns.

**Heavy-duty aluminum four-drive-roll system.**

**Uses 4-, 8- or 12-inch (102, 203 or 305 mm) spools.**

**Fan-On-Demand™** cooling system only operates when needed, reducing power consumption and keeping internal components cleaner.

Industrial ● **CV DC 3 1**  
Phase Phase

## Processes

- MIG (GMAW) = Flux-cored (FCAW)
- Pulsed MIG (GMAW-P)

## Comes complete with

- 15 ft. (4.5 m) Bernard® BTB Gun 300 A with Centerfire™ consumables
- 10 ft. (3 m) work cable with clamp
- 10 ft. (3 m) industrial power cord (without plug) for single- or three-phase
- Factory-installed gas solenoid
- Flow gauge regulator and gas hose for argon or AR/CO<sub>2</sub> mix
- Factory-installed, low-mounted running gear/cylinder rack
- .035/.045 in. reversible V-groove drive rolls (order U-groove drive rolls for aluminum welding)
- Extra contact tips

## Most popular accessories

- Spoolmatic® Spool Gun (pg 28) (non-Pro gun only)
- XR™ Air-Cooled Push-Pull Guns (pg 29)
- Dual Cylinder Rack 195299 (pg 118)
- Protective Cover 195142 (pg 121)
- 230-Volt Extension Cord 770644

Visit [MillerWelds.com](http://MillerWelds.com) or your distributor for other Miller® options and accessories.

| Stock Number<br>(907300)<br>200/230/460 V | Input Power  | Amperage Range | Rated Output                    | Amps Input at Rated Output, 60 Hz |       |       |      |      | Wire Feed Speed   | Wire Type and Diameter Capacity  | Dimensions   | Net Weight      |
|---|--------------|----------------|---------------------------------|-----------------------------------|-------|-------|------|------|---|--|--|-----------------|
|   |              |                |                                 | 200 V                             | 230 V | 460 V | KVA  | KW   |   |  |  |                 |
|   | Three-phase  | 25-400         | 300 A at 32 VDC, 60% duty cycle | 34                                | 30    | 15    | 11.6 | 11.5 | MIG gun<br>50-700 ipm (1.3-17.8 m/min.)<br>Optional spool gun/push-pull gun<br>50-800 ipm (1.3-20 m/min.) | Solid steel .023-.045 in. (0.6-1.2 mm)<br>Stainless .030-.045 in. (0.8-1.2 mm)<br>Aluminum .035-.047 in. (0.9-1.2 mm)<br>Metal-cored .035-.052 in. (0.9-1.3 mm)<br>Flux-cored .030-.052 in. (0.8-1.3 mm) | H: 34 in. (863 mm)<br>W: 19 in. (483 mm)<br>D: 41 in. (1,041 mm) | 181 lb. (82 kg) |
|   | Single-phase |                |                                 | 69                                | 61    | 30    | 13.1 | 11.2 |   |  |  |                 |

# Millermatic® 350P Aluminum

See literature DC/12.56



Millermatic 350P Aluminum with XR-Aluma-Pro™ Lite gun shown.

## Welding Capability

|                      |
|----------------------|
| Max. 1/2 in. (13 mm) |
| Aluminum             |
| Min. 18 ga. (1.2 mm) |

Aluminum welding uses optional XR-Aluma-Pro push-pull gun. Not compatible with standard MIG gun.

**True torque feed motor push-pull design** provides continuous push force to the wire while the gun motor controls the speed at the gun. The motors work together to provide accurate and positive wire feed speed without wire shaving or deformation.

**Electronic wire spool brake** allows wire spool to free spool while welding, resulting in smooth wire delivery.

**Synergic MIG and synergic pulsed MIG** provide communication between power source, feeder and gun. As wire speed increases/decreases, the pulse or MIG parameters also increase/decrease to match the right amount of power needed.

**Built-in aluminum pulsed MIG programs** for simplicity and improved puddle control. Pulsed welding virtually eliminates burn-through and warping issues on thinner materials.

**Trigger schedule select** allows operator to change between two sets of weld parameters.

**Trigger hold** reduces operator fatigue on extended welds.

Industrial ● **CV DC 3 1**  
Phase Phase

## Processes

- Aluminum MIG (GMAW)
- Aluminum pulsed MIG (GMAW-P)

## Comes complete with

- 10 ft. (3 m) work cable with clamp
- 10 ft. (3 m) industrial power cord (without plug) for single- or three-phase
- Factory-installed gas solenoid
- Flow gauge regulator and gas hose for argon
- Factory-installed, low-mounted running gear/cylinder rack
- .035 and .047 in. (0.9 and 1.2 mm) U-groove drive rolls for aluminum welding

## Push-pull gun systems include above plus

- XR™ air-cooled push-pull gun (see choices far left in chart below)

## Most popular accessories

- XR™ Air-Cooled Push-Pull Guns (pg 29)
- Dual Cylinder Rack 195299 (pg 118)
- Protective Cover 195142 (pg 121)
- 230-Volt Extension Cord 770644

Visit [MillerWelds.com](http://MillerWelds.com) or your distributor for other Miller® options and accessories.

| Stock Number   | Input Power  | Amperage Range | Rated Output                    | Amps Input at Rated Output, 60 Hz |       |       |      |      | Wire Feed Speed                                      | Wire Type and Diameter Capacity     | Dimensions   | Net Weight      |
|--|--------------|----------------|---------------------------------|-----------------------------------|-------|-------|------|------|--|-------------------------------------|--|-----------------|
|  |              |                |                                 | 200 V                             | 230 V | 460 V | KVA  | KW   |  |                                     |  |                 |
| Millermatic 350P Aluminum Push-Pull Gun System (951451) w/15 ft. XR-Aluma-Pro™ air-cooled gun (951452) w/25 ft. XR-Aluma-Pro™ air-cooled gun (951453) w/25 ft. XR™-Pistol-Pro air-cooled gun (951454) w/25 ft. XR-Aluma-Pro™ Lite air-cooled gun | Three-phase  | 25-400         | 300 A at 32 VDC, 60% duty cycle | 34                                | 30    | 15    | 11.6 | 11.5 | Optional push-pull gun<br>50-800 ipm (1.3-20 m/min.) | Aluminum .035-.047 in. (0.9-1.2 mm) | H: 34 in. (863 mm)<br>W: 19 in. (483 mm)<br>D: 41 in. (1,041 mm) | 181 lb. (82 kg) |
|  | Single-phase |                |                                 | 69                                | 61    | 30    | 13.1 | 11.2 |  |                                     |  |                 |
| Millermatic 350P Aluminum (gun NOT included) (907474) 200/230/460 V standard unit  |              |                |                                 |                                   |       |       |      |      |  |                                     |  |                 |

# AlumaFeed<sup>®</sup> Synergic Aluminum Welding Systems

See literature DC/34.0

**Dedicated aluminum system for the most advanced MIG and synergic pulsed MIG performance.**



AlumaPower™ 350 MPa and XR-AlumaFeed® SuitCase™ with XR-Aluma-Pro gun air-cooled package shown.

**AUTO-LINE TECHNOLOGY** AlumaPower™ 350 model allows for any input voltage hookup (208–575 V, single- or three-phase) with no manual linking, providing convenience in any job setting. Ideal solution for dirty or unreliable power. 450 model is 230/460 V manual link or 575 V, three-phase only.

**Impact-resistant and flame-retardant suitcase-style feeder.**

**Synchronized, true push-pull wire feed system** for precise wire feeding and arc performance.

**Profile Pulse™** provides TIG appearance with MIG simplicity and productivity. Achieve “stacked dimes” without gun manipulation. Profile Pulse frequency can be changed to increase or decrease the spacing between the ripple pattern to achieve the desired weld appearance.



**Synergic pulsed MIG.** As wire speed increases/decreases, pulse parameters also increase/decrease to match the right amount of power needed, reducing the need to make additional adjustments.

**Built-in MIG and pulsed MIG programs** automatically set the optimal parameters for a wide variety of wires making it easy to set up and use.

**Parameter and system locks** enhance quality assurance and protect weld consistency.

**Trigger schedule select** allows operator to change between two sets of weld parameters.

**Heavy industrial**  **CV DC 3 1** AlumaPower 450 is 3-phase only.  
Phase Phase

**Processes**

- Aluminum MIG (GMAW)
- Aluminum pulsed MIG (GMAW-P)

**Most popular accessories**

- XR™ Push-Pull Guns (pg 29)
- MIGRunner™ Cart 195445 (pg 119)
- Coolmate™ 3 043007 (pg 119)
- Coolant 043810 (pg 119)
- Industrial MIG 4/0 Kits (pg 121)
  - 300405 With Dinse connectors (350 MPa only)
  - 300390 With lug connectors (450 MPa only)
- Consists of flowmeter regulator with 10 ft. (3 m) gas hose, 10 ft. (3 m) 4/0 feeder weld cable, and 15 ft. (4.6 m) work cable with 600-amp C-clamp
- Extension Cables (pg 126)
  - 247831025 25 ft. (7.6 m)
  - 247831050 50 ft. (15 m)
  - 247831080 80 ft. (24.4 m)
- 1/16-Inch (1.6 mm) Liner and Wire Kit for Gun 230708
- 1/16-Inch (1.6 mm) Drive Roll Kit for Control Box 195591
- For gun and feeder remote options, see literature DC/34.0 or visit MillerWelds.com

Visit [MillerWelds.com](http://MillerWelds.com) or your distributor for other Miller® options and accessories.



**Models/Packages**

\*Additional packages are available – visit [MillerWelds.com](http://MillerWelds.com) or your distributor.



| Power Source Only Stock Number  | Package Stock Number*         | XR-AlumaFeed SuitCase Feeder | XR-Aluma-Pro™ Push-Pull MIG Gun | XR™-Pistol-Pro Push-Pull MIG Gun | Industrial MIG 4/0 Kit | Coolmate™ with Coolant | Cart           |
|---|-------------------------------|------------------------------|---------------------------------|----------------------------------|------------------------|------------------------|----------------|
| <b>AlumaPower 350 MPa</b><br>(907420) 208–575 V<br>(907420001) 208–575 V with auxiliary power         | (951834) w/350 model (907420) | (301567)                     | 25 ft. air-cooled               | –                                | –                      | –                      | –              |
|   | (951836) w/350 model (907420) | (301567)                     | –                               | 25 ft. air-cooled                | –                      | –                      | –              |
|   | (951833) w/350 model (907420) | (301567)                     | 25 ft. air-cooled               | –                                | –                      | With Dinse connectors  | MIGRunner cart |
| <b>AlumaPower 450 MPa</b><br>(907483) 230/460 V w/auxiliary power<br>(907484) 575 V w/auxiliary power | (951840) w/450 model (907483) | (301567)                     | 25 ft. air-cooled               | –                                | –                      | –                      | MIGRunner cart |
|   | (951839) w/450 model (907483) | (301567)                     | 25 ft. water-cooled             | –                                | –                      | Coolmate 3             | MIGRunner cart |

Note: All packages listed include gun drive rolls, feeder drive rolls and consumables for .035- and 3/64-inch (0.9 and 1.2 mm) wire. All systems come set up out of the box to run 3/64-inch wire. 1/16-inch consumables not included – order separately above.

| Model                     | Input Power  | Amp/Volt Ranges     | Rated Output                          | Amps Input at Rated Load Output, 60 Hz |       |       |       |       | KVA                     | KW   | Max. Open-Circuit Voltage | Dimensions  | Net Weight           |
|---------------------------|--------------|---------------------|---------------------------------------|--|-------|-------|-------|-------|-------------------------|------|---------------------------|---|----------------------|
|                           |              |                     |                                       | 208 V                                  | 230 V | 400 V | 460 V | 575 V |                         |      |                           |   |                      |
| <b>AlumaPower 350 MPa</b> | Three-phase  | 5–425 A<br>10–38 V  | 350 A at 34 VDC,<br>60% duty cycle    | 40.4                                   | 36.1  | 20.6  | 17.8  | 14.1  | 14.2                    | 13.6 | 75 VDC                    | H: 17 in. (432 mm)<br>W: 12.5 in. (318 mm)<br>D: 24 in. (610 mm)        | 80 lb.<br>(36.3 kg)  |
|                           | Single-phase | 5–425 A<br>10–38 V  | 300 A at 32 VDC,<br>60% duty cycle    | 60.8                                   | 54.6  | 29.7  | 24.5  | 19.9  | 11.7                    | 11.2 |                           |   |                      |
| <b>AlumaPower 450 MPa</b> | Three-phase  | 15–600 A<br>10–38 V | 450 A at 36.5 VDC,<br>100% duty cycle | –                                      | 49.4  | –     | 27.2  | 23.6  | 21.6<br>(23.5 on 575 V) | 18.3 | 90 VDC                    | H: 17.25 in. (438 mm)<br>W: 14.5 in. (368 mm)<br>D: 27.125 in. (689 mm) | 122 lb.<br>(55.3 kg) |

| XR-AlumaFeed SuitCase Feeder   | Input Power                 | Input Welding Circuit Rating   | Wire Feed Speed               | Wire Diameter Capacity   | Maximum Spool Size Capacity | Dimensions  | Net Weight          |
|--|-----------------------------|--|-------------------------------|--|-----------------------------|---|---------------------|
| 14-pin compliant, but only operates synergically w/MPa power sources | 24 VAC,<br>5 A,<br>50/60 Hz | 400 A at 100% duty cycle<br>System duty cycle is limited to gun rating | 50–900 ipm<br>(1.3–23 m/min.) | .035–1.16 in. (0.9–1.6 mm)<br>Requires gun wire kit (230708) and control box drive roll kit (268850) to run 1/16 in. (1.6 mm) wire | 12 in. (305 mm)             | H: 15.5 in. (394 mm)<br>W: 9 in. (229 mm)<br>D: 21 in. (533 mm) | 31 lb.<br>(14.1 kg) |

# Deltaweld® Systems See literature DC/16.5

The new standard in manufacturing provides the solution for welders of all skill levels, plus pulsed MIG capabilities with Intellex™ Pro integrated packages.

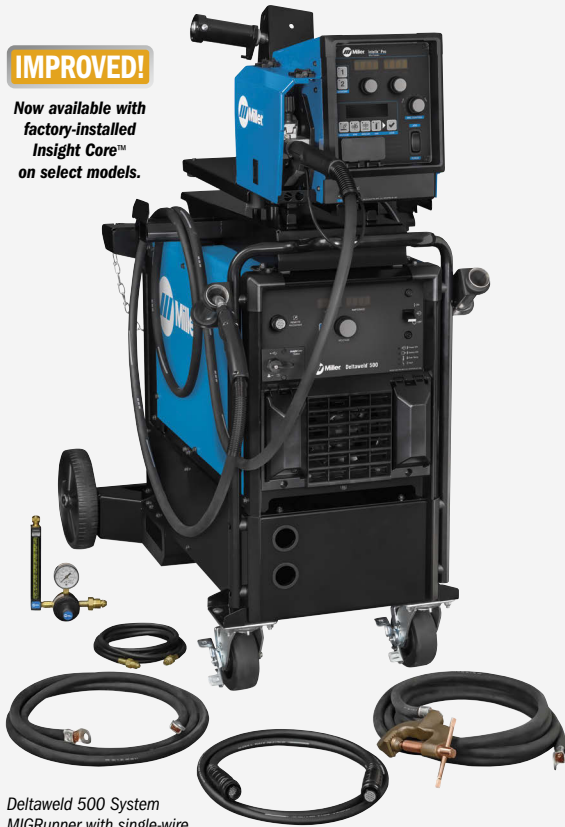

**IMPROVED!**

Now available with factory-installed Insight Core™ on select models.

Deltaweld 500 System MIGRunner with single-wire Intellex Pro feeder and factory-installed Insight Core shown.

**Reduce the time and hassle of setting up welding systems. Make your move to a weld-ready Deltaweld MIGRunner™.**

**Ships as a complete package.**

Just hook up your primary power, add gas, wire and welding gun, and you're ready to weld.

**Versatile MIGRunner cart** keeps you organized with dual cylinder rack, MIG gun holders, and storage compartment beneath power source; and portable with lockable front casters and oversized rear wheels.

**Old Deltaweld® System**



Time spent assembling old Deltaweld package

**New Deltaweld® System**



Time spent assembling new Deltaweld package



**Quality-engineered cable management** protects your connections to keep you productive.



**Single-wire feeder swivels** for convenience and function, reducing wear on gun and liner assembly. It moves with the MIG gun, allowing operator to see the front of the feeder and which parameters are selected.

| Model                                      | Single-Wire Intellex Feeder MIGRunner | Single-Wire Intellex Pro Feeder MIGRunner | Dual-Wire Intellex Feeder MIGRunner | Dual-Wire Intellex Pro Feeder MIGRunner |
|--|---------------------------------------|---|-------------------------------------|---|
| <b>Most Popular MIGRunner</b> ◀            |                                       |   |                                     |   |
| Deltaweld 350 208/230/460 V                | (951792)                              | (951777) ◀                                | (951817)                            | (951818)                                |
| Deltaweld 350 w/Insight Core 208/230/460 V | –                                     | (951825)                                  | –                                   | –                                       |
| Deltaweld 500 208/230/460 V                | (951814)                              | (951808) ◀                                | (951819)                            | (951820)                                |
| Deltaweld 500 w/Insight Core 208/230/460 V | –                                     | (951826)                                  | –                                   | –                                       |
| Deltaweld 500 575 V                        | –                                     | (951824)                                  | –                                   | –                                       |
| Deltaweld 500 w/Insight Core 575 V         | –                                     | (951827)                                  | –                                   | –                                       |

## Deltaweld Power Sources



Deltaweld 350 with factory-installed Insight Core shown.

Deltaweld 500 with factory-installed Insight Core shown.

**Two power source choices**

- **Deltaweld 350** has auxiliary power standard and optional 14-pin receptacle and meters for use with legacy feeders.
- **Deltaweld 500** has auxiliary power and meters standard and an optional 14-pin receptacle. It adds more power (500 amps at 100 percent duty cycle) and a dedicated gouge mode for up to 3/8-inch carbons.

**ArcConnect™** is a next generation communication that utilizes high-speed signals to improve weld performance and allow point-of-use controls to be located at the feeder.

**Wind Tunnel Technology™** Internal air flow that protects components, greatly improving reliability.

**Fan-On-Demand™** cooling system only operates when needed, reducing power consumption and keeping internal components cleaner.

**Welding Intelligence™** Get more done, produce higher-quality welds and control costs with Insight Core (factory-installed option on select models). Gives owners/managers visibility of welder productivity, so they can make informed decisions to drive improvements (see page 70).

# Intelx™ Wire Feeders



Feeders include a Bernard® BTB Gun 300 A (two with dual-wire models) with .035/.045 in. drive rolls and Centerfire™ contact tips.



## Dedicated wire feeder options

- Intelx™ feeders with arc control feature means welders can produce better welds with minimal parameter adjustments.
- Intelx™ Pro feeders add Accu-Pulse®, EZ-Set, steel weld programs, and memory buttons. Accu-Pulse® provides a 28 percent wider operating window and a more forgiving arc, while EZ-Set simplifies parameter setup based on material thickness, removing complexity.

**Dual-wire models** allow two different wire types to be available on one feeder, avoiding downtime from changing spools and drive rolls.

**User-friendly interface** makes the system easy to set up and adjust with minimal training.

**Rotatable drive assembly** allows operator to rotate the drive, eliminating severe bends in the wire feed path. This extends gun-liner life and aids in feeding difficult wires.

**Balanced-pressure drive-roll design and tensioners** feed wire in its truest and straightest form for consistent feedability and better welding performance.

## Intelx Feeder Features

| Feature                          | Intelx | Intelx Pro |
|----------------------------------|--------|------------|
| Digital meters                   | ●      | ●          |
| Remote voltage                   | ●      | ●          |
| Wire feed speed                  | ●      | ●          |
| Arc control                      | ●      | ●          |
| Trigger hold                     | ●      | ●          |
| Wire jog and purge               | ●      | ●          |
| Wire feed speed feedback         | ●      | ●          |
| Four drive rolls                 | ●      | ●          |
| Rotatable drive                  | ●      | ●          |
| Up to 60 lb. spool               | ●      | ●          |
| MIG process                      | ●      | ●          |
| Dual-wire models                 | ●      | ●          |
| EZ-Set MIG                       |        | ●          |
| EZ-Set Accu-Pulse®               |        | ●          |
| Trigger select                   |        | ●          |
| Preflow                          |        | ●          |
| Postflow                         |        | ●          |
| Memory slots (2)                 |        | ●          |
| Out-of-box programs (steel only) |        | ●          |

# Intelx™ Pro Swingarc™

Models include control cable, Bernard® BTB Gun 400 A (two with dual-wire models) with Centerfire™ contact tips, and .035/.045 in. drive rolls.

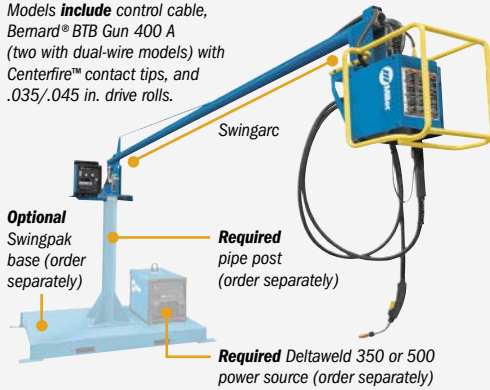

**Single- and dual-wire models with 12- or 16-foot booms** are sized to accommodate a variety of weld cell layouts (24- or 32-foot diameter work area).

**Counterbalance design** makes it easy to position boom and **360-degree rotation and 60-degree lift angle** maximize work area.

**In-boom cable routing** organizes hoses and cables for a cleaner work environment.

| Model               | Single-Wire Intelx Pro Swingarc | Dual-Wire Intelx Pro Swingarc |
|---------------------|---------------------------------|-------------------------------|
| 12 ft. (3.7 m) Boom | (951804)                        | (951805)                      |
| 16 ft. (4.9 m) Boom | (951806)                        | —                             |

\*Additional models are available — visit MillerWelds.com or your distributor.  
\*\*Refer to Deltaweld 500 owner's manual for gouge mode ratings and KVA/ KW for 575 V models.

## Heavy industrial ● CV DC 3 Phase

### Processes

- MIG (GMAW) ■ Flux-cored (FCAW)
- Accu-Pulse® MIG (GMAW-P) with Intelx Pro feeder
- Air carbon arc gouging (CAC-A) with Deltaweld 500

### MIGRunner™ packages include

- Deltaweld power source  
350: 907747 or 907747002  
500: 907785 or 907785002  
500 (575 V): 907786 or 907786002
- Intelx OR Intelx Pro wire feeder
- Bernard® BTB Gun(s)  
(350: 300 A OR 500: 400 A) and .035/.045 in. V-groove drive rolls
- Factory-installed Deltaweld running gear with cable holder, gun holders, and chains for gas cylinders

- Cart accessory kit consisting of flowmeter regulator(s) with 5 ft. (1.5 m) gas hose(s), 10 ft. (3 m) 4/0 feeder weld cable with lugs, 15 ft. (4.6 m) work cable with 600-amp C-clamp, and 9 ft. (2.7 m) ArcConnect cable
- Quick-setup guide and video

### Most popular accessories

- Bernard® MIG Guns (pg 25-26)
- Deltaweld 350/500 Running Gear 301523 (pg 119)
- Industrial MIG 4/0 Kits with lugs (stationary packages only) (pg 121)
- ArcConnect Control/Motor Cables  
280471009 9 ft. (2.7 m)  
280471015 15 ft. (4.6 m)  
280471025 25 ft. (7.6 m)  
280471050 50 ft. (15.2 m)  
280471075 75 ft. (22.9 m)  
280471100 100 ft. (30.5 m)  
280471150 150 ft. (45.7 m)
- Cart Accessory Kit 301528 (see above for contents)  
Note: For dual-wire feeder kit both 301528 and 301579 are required.
- Feeder Swivel Kit 301533  
Mounts single- or dual-wire feeder to Deltaweld — only single feeder swivels
- Stationary Handle Kit 301529
- Hanging Bail 058435
- Pipe Post with 18 in. Base  
149838 4 ft.  
149839 6 ft.
- Swingpak™ Base 183997
- Single/Dual Spool Carrier for 6 ft. Pipe Post 300352 (see page 22 for more information)

Visit MillerWelds.com or your distributor for other Miller® options and accessories.

| 350 A  | Power Source Only/Stock Number   |             | Amp/Volt Ranges                     | Rated Output**  | Amps Input at Rated Load Output, 60 Hz** |                                    |       |   |      | Power Source Dimensions (Includes lift eye)                | Power Source Net Weight   |                      |
|--|--|-------------|-------------------------------------|---|--|------------------------------------|-------|---|------|--|---|----------------------|
|  | Most Popular Models ◀  |             |                                     |   | 208 V                                    | 230 V                              | 460 V | 575 V   | KVA  |  |   | KW                   |
|  | Deltaweld 350*<br>(907747) ◀ 208/230/460 V<br>(907747001) 208/230/460 V with 14-pin and meters<br>(907747002) 208/230/460 V with Insight Core™   |             | 20-400 A<br>10-38 V                 | 300 A at 29 VDC, 100% duty cycle<br>350 A at 31.5 VDC, 60% duty cycle<br>425 A at 35.25 VDC, 30% duty cycle | 29.3                                     | 26.5                               | 14.6  | —   | 11.6 | 10.0   | H: 22.36 in. (568 mm)<br>W: 15.35 in. (390 mm)<br>D: 29.15 in. (740 mm) | 115 lb.<br>(52.2 kg) |
|  | Deltaweld 500*<br>(907785) ◀ 208/230/460 V with meters<br>(907785001) 208/230/460 V with 14-pin and meters<br>(907785002) 208/230/460 V with meters and Insight Core™<br>(907786) 575 V with meters<br>(907786001) 575 V with 14-pin and meters<br>(907786002) 575 V with meters and Insight Core™ |             | 30-650 A<br>10-44 V                 | 500 A at 39 VDC, 100% duty cycle<br>575 A at 42.75 VDC, 60% duty cycle<br>650 A at 44 VDC, 25% duty cycle   | 64.2                                     | 58.1                               | 30.4  | 24.8  | 24.2 | 21.7   | H: 22.36 in. (568 mm)<br>W: 15.35 in. (390 mm)<br>D: 31.65 in. (804 mm) | 145 lb.<br>(65.8 kg) |
| Feeder Only/Stock Number   |  | Input Power | Input Welding Circuit Rating        | Wire Feed Speed   | Wire Diameter Capacity                   | Maximum Spool Size Capacity        |       | Dimensions (H x W x D)  |      | Net Weight   |   |                      |
| Intelx (951783) Single-wire<br>Intelx Pro (951784) ◀ Single-wire<br>Intelx (951815) Dual-wire<br>Intelx Pro (951816) Dual-wire |  | 50 VDC      | 600 A at 113 VDC,<br>60% duty cycle | 50-780 ipm<br>(1.3-19.8 m/min.)   | .023-5/64 in.<br>(0.6-2.0 mm)            | 18 in. (457 mm),<br>60 lb. (27 kg) |       | Single: 16.25 x 12.38 x 27.88 in.<br>(413 x 314 x 708 mm)<br>Dual: 14 x 18 x 34.5 in.<br>(356 x 457 x 876 mm) |      | Single: 44.8 lb.<br>(20.3 kg)<br>Dual: 77 lb.<br>(34.9 kg) |   |                      |

# Invision™ MPa Plus Systems

See literature DC/23.6

MIG and synergic pulsed MIG system with optimized weld programs for both steel and aluminum.



Invision 352 MPa

Invision 450 MPa



**Recommended Aluminum Solution**

Dedicated XR Plus guns work with MPa Plus feeders. See page 21 for information and stock numbers.

**Auto-Line™** Invision 352 allows for any input voltage hookup (208–575 V, single- or three-phase) with no manual linking. 450 model is 230/460 V manual link or 575 V, three-phase only.

**Profile Pulse™** provides TIG appearance with MIG simplicity and productivity. Achieve “stacked dimes” without gun manipulation. Profile Pulse frequency can be changed to increase or decrease spacing between the ripple pattern.



**Synergic pulsed MIG when using a 70 Series MPa Plus feeder.** As wire speed increases/decreases, pulse parameters also increase/decrease to match the right amount of power needed, reducing the need to make additional adjustments.

**Built-in MIG and pulsed MIG programs** automatically set the optimal parameters for a wide variety of wires making it easy to set up and use.

**Heavy industrial** ●  
 Invision 450 is 3-phase only.

**Processes**

- MIG (GMAW) ▪ Flux-cored (FCAW)
- Pulsed MIG (GMAW-P)
- Air carbon arc gouging (CAC-A)

**Most popular accessories**

- 70 Series MPa Plus feeders (pg 20)
- XR-Aluma-Pro™ Plus and XR™-Pistol Plus push-pull guns (pg 21)
- 70 Series Swingarc™ with MPa Plus control box (pg 22)
- Bernard® MIG Guns (pg 25–26)
- MIGRunner™ Cart (pg 119)
- Running Gear Cylinder Rack (pg 119)
- Industrial MIG 4/0 Kits (pg 121)
- Extension Cables (pg 126)

Visit [MillerWelds.com](http://MillerWelds.com) or your distributor for other Miller® options and accessories.

| Model            | Power Source Only Stock Number    | Package Stock Number*         | 70 Series MPa Plus Feeder with .035/.045 in. Drive Rolls and Bernard BTB 400 A Gun | XR-Aluma-Pro™ Plus Push-Pull MIG Gun               | Industrial MIG 4/0 Kit | Cart                       |
|------------------|-----------------------------------|-------------------------------|--|--|------------------------|----------------------------|
| Invision 352 MPa | (907431) 208–575 V                | Alum (951844) w/model 907431  | D-74 dual-wire feeder with two push-only MIG guns                                  | 25 ft. air-cooled                                  | Dinse connectors       | Running gear cylinder rack |
|                  | (907431001) 208–575 V w/aux power |                               | (951411) w/model 907431  | S-74 single-wire feeder with one push-only MIG gun | –                      | Dinse connectors           |
| Invision 450 MPa | (907485) 230/460 V w/aux power    | Steel (951499) w/model 907485 | S-74 single-wire feeder with one push-only MIG gun                                 | –  | Lug connectors         | MIGRunner cart             |
|                  | (907486) 575 V w/aux power        |                               | (951457) w/model 907485  | D-74 dual-wire feeder with two push-only MIG guns  | –                      | Lug connectors             |

\*Additional packages are available — visit [MillerWelds.com](http://MillerWelds.com) or your distributor.

| Model            | Input Power  | Amp/Volt Ranges   | Rated Output                       | Amps Input at Rated Load Output, 60 Hz |       |       |       |       | KVA                  | KW   | Max. Open-Circuit Voltage | Dimensions  | Net Weight        |
|------------------|--------------|-------------------|------------------------------------|--|-------|-------|-------|-------|----------------------|------|---------------------------|---|-------------------|
|                  |              |                   |                                    | 208 V                                  | 230 V | 400 V | 460 V | 575 V |                      |      |                           |   |                   |
| Invision 352 MPa | Three-phase  | 5–425 A, 10–38 V  | 350 A at 34 VDC, 60% duty cycle    | 40.4                                   | 36.1  | 20.6  | 17.8  | 14.1  | 14.2                 | 13.6 | 75 VDC                    | H: 17 in. (432 mm)<br>W: 12.5 in. (318 mm)<br>D: 24 in. (610 mm)        | 80 lb. (36.3 kg)  |
|                  | Single-phase | 5–425 A, 10–38 V  | 300 A at 32 VDC, 60% duty cycle    | 60.8                                   | 54.6  | 29.7  | 24.5  | 19.9  | 11.7                 | 11.2 |                           |   |                   |
| Invision 450 MPa | Three-phase  | 15–600 A, 10–38 V | 450 A at 36.5 VDC, 100% duty cycle | –                                      | 49.4  | –     | 27.2  | 23.6  | 21.6 (23.5 on 575 V) | 18.3 | 90 VDC                    | H: 17.25 in. (438 mm)<br>W: 14.5 in. (368 mm)<br>D: 27.125 in. (689 mm) | 122 lb. (55.3 kg) |

**Miller recommends**



Hobart® aluminum filler metals — wire and cut lengths — have been designed to provide the best performance for the best welds. These products are backed by the deep industry knowledge of Hobart welding specialists who can help customers find the right aluminum filler metal solution. Every time. No matter how challenging the application.

Visit [HobartBrothers.com](http://HobartBrothers.com) or your local distributor to learn more.

**Questions? Hobart is here to help.**

# Continuum™ Systems See literature DC/36.0

Next generation of advanced industrial welding solutions improves productivity through weld quality, ease of use and system flexibility.



Continuum 350 push-only MIGRunner package shown (motor cable not pictured).

## More power – better reliability

Up to 26 percent more welding output (than competitive models) for demanding industrial applications.

**AUTO-LINE TECHNOLOGY** Allows for any input voltage hookup (230–575 V, three-phase) with no manual linking, providing convenience in any job setting. Ideal solution for dirty or unreliable power.

## Power source design

**Smart and powerful digital design** has the fast response needed to deliver the most stable welding performance for better welding results.

**Flexible** to meet current and future needs with integrated expansion capabilities.

**Welding Intelligence™** Get more done, produce higher-quality welds and control costs.

- **Insight Core™** (standard) gives owners/managers visibility of welder productivity, so they can make informed decisions to drive improvements (see page 70).
- **Insight Centerpoint™** (optional) gives real-time guidance to welders, so less training is required and weld quality is improved (see page 71).

## Feeder design

**Tru-Feed™ technology** provides precise feeding operation for stable arc performance.

- **Low-inertia motor** provides faster response for the best arc starts with the least amount of spatter.
- **Balanced-pressure drive-roll design and tensioners** feed wire in its truest and straightest form for consistent feedability, resulting in better welding performance.

**User-friendly interface** makes the system easy to set up and adjust with minimal training.

Heavy industrial

## Processes

- Accu-Pulse® MIG (GMAW-P)
- Versa-Pulse™ ▪ RMD® ▪ MIG (GMAW)
- High-deposition MIG (GMAW)
- Flux-cored (FCAW)
- Air carbon arc gouging (CAC-A)

## MIGRunner™ packages include

- Continuum power source
- **Push-only pkg:** Continuum single-wire feeder with Bernard® BTB Gun 400 A and .035/.045 in. V-groove drive rolls
- **Push-pull pkg:** Continuum dual-wire feeder with XR-Aluma-Pro Plus gun and .035/.047 in. U-groove drive rolls, and Bernard® BTB Gun 400 A and .035/.045 in. V-groove drive rolls
- Continuum running gear/cylinder rack and handles/cable hangers
- 3 ft. (0.9 m) control/motor cable
- Industrial MIG 4/0 kit consisting of flowmeter regulator(s) with 10 ft. (3 m) gas hose(s), 10 ft. (3 m) 4/0 feeder cable with lugs, and 15 ft. (4.6 m) work cable with 600-amp C-clamp

## Wire feeding options

- Continuum Feeders\* (see chart below)
- Continuum Swingarc™ Boom-Mounted Feeders\*
  - 951635 12 ft. (3.7 m) single-wire
  - 951636 16 ft. (4.9 m) single-wire
  - 951725 12 ft. (3.7 m) dual-wire

\*Feeders include a Bernard BTB Gun 400 A (two with dual-wire models) and .035/.045 in. V-groove drive rolls.

▪ See literature DC/36.0 for additional booms and options

## Most popular accessories

- Bernard® MIG Guns (pg 25–26)
- Insight Centerpoint™ Software (pg 71)
- Continuum Running Gear/Cylinder Rack 301264 (pg 119)
- Industrial MIG 4/0 Kits (with lug connectors) (pg 121)
- Continuum Integrated Cooler 301214 Mounts to bottom of power source – does not require external power
- Continuum Control/Motor Cables
  - 263368003 3 ft. (0.9 m)
  - 263368015 15 ft. (4.6 m)
  - 263368025 25 ft. (7.6 m)
  - 263368050 50 ft. (15 m)
  - 263368080 80 ft. (24.4 m)
  - 263368100 100 ft. (30.5 m)

Visit MillerWelds.com or your distributor for other Miller® options and accessories.

## Continuum Processes

| Best For               | Standard Spray | High-Deposition MIG | Accu-Pulse | Versa-Pulse | Short Circuit | RMD |
|------------------------|----------------|---------------------|------------|-------------|---------------|-----|
| Deposition             | A              | A                   | A          | B           | D             | D   |
| Gap Filling            | D              | D                   | B          | B           | A             | A   |
| Low Heat Input         | D              | C                   | B          | A           | A             | A   |
| Out-of-Position Welds  |                |                     | A          | B           | B             | B   |
| Low Spatter            | A              | A                   | A          | B           | C             | B   |
| Thick Metals           | A              | A                   | A          | C           | D             | D   |
| Thin Metals            |                |                     | B          | A           | A             | A   |
| Increased Travel Speed | A              | A                   | A          | A           | B             | C   |

HOT COLD

**Ratings A, B, C, and D** are relative values. An "A" rating indicates a best fit between your performance needs and process.

A "blank" rating indicates that the process is not recommended for that application.

**Accu-Pulse** is the most popular process for majority of industrial welding applications.

**Versa-Pulse** is a fast, low-heat, low-spatter process designed for thin-material applications.

**RMD** is a low-heat, modified short-circuit process designed to fill gaps with thin-material applications.

**High-deposition MIG** provides increased deposition rates over standard spray on thicker materials.

\*While idling.

| Model                | Stock Number  | Amp/Volt Ranges     | Rated Output                             | Amps Input at Rated Output, 50/60 Hz, 3-Phase |       |       |       |       |      | Max. Open-Circuit Voltage | Power Source Dimensions (Includes lift eye) | Power Source Net Weight  |                      |
|----------------------|---|---------------------|--|---|-------|-------|-------|-------|------|---------------------------|---|--|----------------------|
|                      |   |                     |  | 230 V   | 380 V | 400 V | 460 V | 575 V | KVA  | KW                        |   |  |                      |
| <b>Continuum 350</b> | (951852) 230–575 V push-only MIGRunner package  | 20–400 A<br>10–44 V | 350 A at<br>31.5 VDC,<br>100% duty cycle | 36.7  | 21.8  | 20.8  | 18.8  | 14.6  | 14.4 | 13.8                      | 71 VDC                                      | H: 27.187 in. (691 mm)<br>W: 17.5 in. (444 mm)<br>D: 28.125 in. (714 mm) | 127 lb.<br>(57.6 kg) |
|                      | (951865) 230–575 V push-pull MIGRunner package<br>(907636) 230–575 V power source only<br>(907636001) 230–575 V with running gear/cylinder rack |                     |  | 0-1*  | 0-1*  | 0-1*  | 0-1*  | 0-1*  | 0.8* | 0.17*                     |   |  |                      |
| <b>Continuum 500</b> | (951853) 230–575 V push-only MIGRunner package  | 20–600 A<br>10–44 V | 500 A at<br>39 VDC,<br>100% duty cycle   | 57.6  | 34.7  | 33.2  | 28.9  | 23.3  | 23.1 | 21.9                      | 71 VDC                                      | 148 lb.<br>(67.1 kg)   |                      |
|                      | (951866) 230–575 V push-pull MIGRunner package<br>(907640) 230–575 V power source only<br>(907640001) 230–575 V with running gear/cylinder rack |                     |  | 0-1*  | 0-1*  | 0-1*  | 0-1*  | 0-1*  | 0.8* | 0.17*                     |   |  |                      |

| Model/Stock Number  | Input Power | Input Welding Circuit Rating | Wire Feed Speed                                | Wire Diameter Capacity        | Maximum Spool Size Capacity        | Dimensions   | Net Weight   |
|---|-------------|------------------------------|--|-------------------------------|------------------------------------|--|--|
| <b>Continuum Feeder</b><br>(951631) Single-wire model<br>(951673) Dual-wire model | 50 VDC      | 500 A at<br>100% duty cycle  | Standard:<br>50–1,000 ipm<br>(1.3–25.4 m/min.) | .035–5/64 in.<br>(0.9–2.0 mm) | 18 in. (457 mm),<br>60 lb. (27 kg) | H: 13.812 in. (351 mm)<br>Single W: 16.312 in. (414 mm)<br>Dual W: 17 in. (432 mm)<br>D: 29.687 in. (754 mm) | Single: 43 lb. (19.5 kg)<br>Dual: 61.5 lb. (27.9 kg) |

# Auto-Continuum™ Systems

See literature AU/10.0

Next generation automation welding solution delivers advanced arc performance to improve throughput and weld quality.



Auto-Continuum 500 shown with robot arm (not included) and Auto-Continuum wire drive motor assembly.



Close-up of Auto-Continuum wire drive motor assembly (left-hand drive).

**More power – better reliability.** Up to 26 percent more welding output (than competitive models) for demanding industrial applications.

**AUTO-LINE TECHNOLOGY** Allows for any input voltage hookup (230–575 V, three-phase) with no manual linking, providing convenience in any job setting. Ideal solution for dirty or unreliable power.

**Improve work environment and reduce spatter.** Versa-Pulse and Accu-Pulse processes reduce fume generation, and by precisely controlling the welding arc they also reduce spatter size and quantity. Fume generation can be reduced up to 50 percent over traditional CV MIG.

- **Versa-Pulse** is a fast, low-heat, low-spatter process for high-speed automation on thin materials and is great for gap filling.
- **Accu-Pulse** is better for out-of-position welds, provides higher deposition rates and is designed for thicker materials than Versa-Pulse.

**Easy communication** from robot to power source.

**Designed for easy integration** with fixed and flexible automation.

**Fleet standardization.** Auto-Continuum can be used for both automation and hand-held applications.

**Welding Intelligence™** Get more done, produce higher-quality welds and control costs.

- **Insight Core™** (standard) gives owners/managers visibility of welder productivity, so they can make informed decisions to drive improvements (see page 70).
- **Insight Centerpoint™** (optional) gives real-time guidance to welders, so less training is required and weld quality is improved (see page 71).

Heavy industrial ● CV DC 3 Phase

**Processes**

- Accu-Pulse® MIG (GMAW-P)
- Versa-Pulse™ ▪ RMD® ▪ MIG (GMAW)
- High-deposition MIG (GMAW)
- Flux-cored (FCAW)

**Most popular accessories**

- Insight Centerpoint™ Software (pg 71)
- Auto-Continuum Robotic MIG Kit 301455  
Consists of 25 ft. (7.6 m) motor control cable, 15 ft. (4.6 m) 90-degree motor control extension cable, 15 ft. (4.6 m) weld cable, flowmeter regulator, 30 ft. (9.1 m) gas hose, 9.8 ft. (3 m) Ethernet cable, .035/.045-inch V-groove drive roll kit with guides, 30 ft. (9.1 m) weld wire conduit assembly, and 10 ft. (3 m) conduit and clamps (for mounting motor control cable, weld cable and gas hose)
- Wire Drive Motor Mounting Brackets 300013 FANUC®/KUKA®/Motoman® 300483 FANUC® 100 and 120 IC
- Motor Control Cables  
263368025 25 ft. (7.6 m)  
263368050 50 ft. (15 m)  
263368080 80 ft. (24.4 m)  
263368100 100 ft. (30.5 m)
- 90-degree Motor Control Extension Cables  
281554015 15 ft. (4.6 m)  
281554025 25 ft. (7.6 m)
- EtherNet/IP™ Communication Cables 300734 9.8 ft. (3 m)  
300736 32.8 ft. (10 m)
- DeviceNet Communication Cable 300021 20 ft. (6.1 m)
- DeviceNet to Analog Adapter 301547

Visit [MillerWelds.com](http://MillerWelds.com) or your distributor for other Miller® options and accessories.

\*While idling.

| Model/Stock Number   | Amp/Volt Ranges     | Rated Output                          | Amps Input at Rated Output, 50/60 Hz, 3-Phase  |              |                               |              |  |              |                   | Max. Open-Circuit Voltage | Dimensions (Includes lift eye)  | Net Weight           |
|--|---------------------|---------------------------------------|--|--------------|-------------------------------|--------------|--|--------------|-------------------|---------------------------|---|----------------------|
|  |                     |                                       | 230 V  | 380 V        | 400 V                         | 460 V        | 575 V  | KVA          | KW                |                           |   |                      |
| <b>Auto-Continuum 350</b><br>(907656) 230–575 V<br>(907658) 230–575 V with auxiliary power | 20–400 A<br>10–44 V | 350 A at 31.5 VDC,<br>100% duty cycle | 36.7<br>0-1*                                   | 21.8<br>0-1* | 20.8<br>0-1*                  | 18.8<br>0-1* | 14.6<br>0-1*   | 14.4<br>0.8* | 13.8<br>0.17*     | 72 VDC                    | H: 27.187 in. (691 mm)<br>W: 17.5 in. (444 mm)<br>D: 28.22 in. (717 mm) | 130 lb.<br>(59.4 kg) |
| <b>Auto-Continuum 500</b><br>(907657) 230–575 V<br>(907659) 230–575 V with auxiliary power | 20–600 A<br>10–44 V | 500 A at 39 VDC,<br>100% duty cycle   | 57.6<br>0-1*                                   | 34.7<br>0-1* | 33.2<br>0-1*                  | 28.9<br>0-1* | 23.3<br>0-1*   | 23.1<br>0.8* | 21.9<br>0.17*     | 72 VDC                    |   | 150 lb.<br>(69 kg)   |
| Model/Stock Number   | Input Power         | Input Welding Circuit Rating          | Wire Feed Speed                                |              | Wire Diameter Capacity        |              | Dimensions   |              | Net Weight        |                           |   |                      |
| <b>Auto-Continuum Wire Drive Motor Assembly</b><br>(301207) Left-hand drive                | 50 VDC              | 500 A at 100% duty cycle              | Standard:<br>50–1,000 ipm<br>(1.3–25.4 m/min.) |              | .035–5/64 in.<br>(0.9–2.0 mm) |              | H: 8.75 in. (222 mm)<br>W: 10 in. (254 mm)<br>D: 10 in. (254 mm) |              | 16.5 lb. (7.5 kg) |                           |   |                      |



For more detailed information, visit

MillerWelds.com/wirefeeders

# Wire Feeders

Also see MIG, MIG Guns and Multiprocess sections for wire feeding options.



## Product Guide

|   | Page | Class | MIG | Pulsed MIG <sup>1</sup> | RMD <sup>1</sup> | Flux-cored <sup>2</sup> | Power Source Required | Wire Types |                      |                      |                | Wire Diameter Capacity     | Special Features  | Typical Applications  |          |
|---|------|-------|-----|-------------------------|------------------|-------------------------|-----------------------|------------|----------------------|----------------------|----------------|----------------------------|---|---|----------|
|   |      |       |     |                         |                  |                         |                       | Hard       | Flux-cored Dual-shld | Flux-cored Self-shld | Alum.          |                            |   |   |          |
| ArcReach® SuitCase® (8 and 12)                    | 18   | ●     | ●   | ●                       |                  | ●                       | CC/CV                 | ●          | ●                    | ● CV <sup>2</sup>    | ●              | .023-5/64 in. (0.6-2.0 mm) | 8 in. (SuitCase 8) or 12 in. (SuitCase 12) diameter spool capacity, remote voltage control without a control cord, powered by arc voltage. ArcReach Suitcase 12 Heavy Duty model available for use with large diameter 3/32-inch cored wire | Construction, site fabrication, field maintenance                       | Portable |
| ArcReach® Smart Feeder                            | 18   | ●     | ●   | ●                       |                  | ●                       | ArcReach equipped     | ●          | ●                    | ●                    | ●              | .035-.045 in. (0.9-1.1 mm) | 12 in. diameter spool capacity, remote voltage control without a control cord, requires an XMT 350 FieldPro connected to three-phase power or an ArcReach-equipped engine drive   | Process piping, refinery, petrochemical, power plants, HVAC, water pipe |          |
| SuitCase® 12RC                                    | 18   | ●     | ●   | ●                       |                  | ●                       | CV                    | ●          | ●                    | ●                    | ●              | .023-5/64 in. (0.6-2.0 mm) | 12 in. diameter spool capacity, standard remote voltage control, powered by 14-pin control cord   | Field maintenance, site fabrication                                     |          |
| 20 Series (Basic and Digital)                     | 20   | ●     | ●   | ●                       |                  | ●                       | CV                    | ●          | ●                    | ●                    | ●              | .023-5/64 in. (0.6-2.0 mm) | Four quick-change drive rolls, digital meters, remote voltage control (meters and remote voltage control are a field kit option on basic model)   | Manufacturing, fabrication  | Bench    |
| 70 Series (74S and 74D) Singles and Duals         | 20   | ●     | ●   | ●                       |                  | ●                       | CV                    | ●          | ●                    | ●                    | ●              | .023-5/64 in. (0.6-2.0 mm) | Four quick-change drive rolls, remote voltage control (field kit option on 74S models), digital meters (74D only)   | Heavy and light manufacturing, fabrication                              |          |
| 70 Series (74 MPa Plus) Singles and Duals         | 20   | ●     | ●   | ●                       |                  | ●                       | CV                    | ●          | ●                    | ●                    | ●              | .023-5/64 in. (0.6-2.0 mm) | XR-Aluma-Pro™ Plus or XR™-Pistol Plus guns for feeding soft wires   | Manufacturing requiring multiple wire types                             |          |
| 70 Series Swingarc™ Singles and Duals             | 22   | ●     | ●   | ●                       |                  | ●                       | CV                    | ●          | ●                    | ●                    | ● <sup>3</sup> | .023-5/64 in. (0.6-2.0 mm) | 12 and 16 ft. booms, four drive rolls, adjustable weld control  | Heavy and light manufacturing, fabrication                              |          |
| 70 Series Remote Configurations Singles and Duals | 22   | ●     | ●   | ●                       |                  | ●                       | CV                    | ●          | ●                    | ●                    | ● <sup>3</sup> | .023-5/64 in. (0.6-2.0 mm) | Control box, cables and wire drive motor assemblies for generic booms or fixed automation   | Heavy and light manufacturing, fabrication                              |          |

### Product Key

Class: ● Light industrial ● Industrial ● Heavy industrial Capability: ● Designed for this process ● Capable of this process

<sup>1</sup> Smart Feeder requires an XMT® 350 FieldPro™ connected to three-phase power or an ArcReach-equipped engine drive. All other feeders require an MPa inverter power source.

<sup>2</sup> Certain self-shielded wires require CV output. Miller recommends a CV power source whenever possible.

<sup>3</sup> 74S and 74D models are capable of aluminum welding. 74 MPa Plus models are designed for aluminum welding.

# SuitCase® Series

## Portable Feeders

Portable SuitCase feeders that set the standard for performance and provide extreme reliability to stand up to the demands of construction and fabrication.

### SuitCase Series Features

| Feature  | ArcReach |    |       |       | 12RC |
|--|----------|----|-------|-------|------|
|  | 8        | 12 | 12 HD | Smart |      |
| Available with Bernard gun:                    |          |    |       |       |      |
| BTB Gun 300 A                                  | ●        | ●  |       |       | ●    |
| S-Gun  | ●        | ●  |       |       |      |
| Dura-Flux gun                                  | ●        | ●  |       |       |      |
| PipeWorx gun                                   |          | ●  |       | ●     |      |
| Remote voltage control (control cord required) |          |    |       |       | ●    |
| Remote voltage control (without a cord)        | ●        | ●  | ●     | ●     |      |
| Digital meters                                 | ●        | ●  | ●     | ●     | ●    |
| Impact-resistant case                          | ●        | ●  | ●     | ●     | ●    |
| Gas purge                                      | ●        | ●  | ●     | ●     | ●    |
| Wire jog                                       | ●        | ●  | ●     | ●     | ●    |
| Feeds 3/32 in. wire                            |          |    | ●     |       |      |



Bernard BTB Gun 300 A shown.

Note: ArcReach SuitCase feeders are compatible with standard power sources and engine-driven welders, but function as standard equipment without remote control capabilities. Full functionality of ArcReach is only available with ArcReach power sources.

Feeders include a male Tweco® connector installed on the weld cable and are available with a Bernard® gun and drive rolls (see chart on page 19), except ArcReach SuitCase 12 Heavy Duty which is sold as a feeder only (gun and drive rolls should be ordered separately). BTB Gun 300 A and S-Gun™ come with reversible dual size (.045 and 1/16 in. V-knurl) drive rolls. Dura-Flux™ flux-cored gun comes with reversible dual size (.068/.072 and 5/64 in. V-knurl) drive rolls. PipeWorx 300-15 gun comes with reversible dual size (.035 V-groove and .045 in. V-knurl) drive rolls.

### Setting the standard for performance

**Heavy-duty drive motor with tachometer control** provides wire feed speed that is accurate and consistent from the start of the weld to the finish and from one weld to the next. Consistent wire feed speed is very important with large-diameter cored wire, because small changes in wire feed speed make large changes in deposition rates.

**Wide voltage range** for small and large wires with no contactor chatter or arc outages.

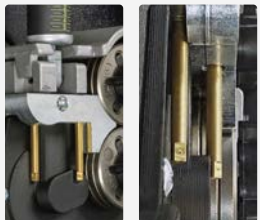

**Ultra-low-drag inlet guide pins** make loading the wire easy and do not deform the wire on the way into the drive rolls, improving wire feeding performance.



**Scaled wire pressure knob** provides easy adjustment and consistent pressure on the drive rolls and wire.

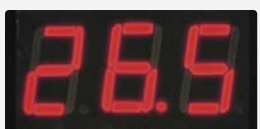

**Digital meters with SunVision™ technology** can display voltage, wire feed speed, and also amperage if desired. Meters can be seen clearly even in direct sunlight.

### Unique and durable case

**Impact-resistant, flame-retardant case** provides strength and durability, while protecting components and welding wire from moisture, dust and other contaminants.

**Built-in slide rails** for positioning and durability.

**Innovative feeder door design** allows you to change wire while feeder is standing upright or laying down.

**ArcReach SuitCase models are available in two sizes.** SuitCase 8 model is sized for an 8-inch spool of wire, can be carried to remote welding sites, and fits through a 14-inch manhole/manway. SuitCase 12 model is sized for an 8- or 12-inch spool of wire. 12-inch spools are the most common in structural steel and fabrication.

### Extreme reliability

**Potted-and-trayed main printed circuit board** for the harshest environments adds exceptional reliability. Board has full-trigger isolation so a shorted gun trigger will not affect feeder operation.



**Gun locking tab** works with guns having corresponding locking grooves to prevent gun from being pulled out if the feeder is dragged by the gun.



**Gas inlet recessed into back of case** is protected from incidental contact by the weld cable, ensuring consistent and contaminant-free shielding gas delivery to the gun. **Double-filtered gas valve** helps keep dirt from clogging and affecting gas flow.

# ArcReach® SuitCase® 8 and 12 and ArcReach Smart Feeder

See literature M/6.55

## ArcReach Remote control of the power source without a cord.

With an ArcReach SuitCase feeder and ArcReach power source you can change output voltage at the feeder, and save a trip to the power supply. No extra control cord to purchase, maintain, string or unstring – saving time and money. See pages 44–46 and 78–84 for ArcReach power sources and engine drives.

**Easy process changeover.** Simply connect the ArcReach feeder to your leads and you are ready to go. All controls automatically shift to the ArcReach feeder.

**Voltage-sensing feeders designed to run off of arc voltage.** The ArcReach SuitCase 8 and 12 operate on the arc voltage of almost any power source. The ArcReach Smart Feeder requires an XMT® 350 FieldPro™ (page 44) connected to three-phase power or an ArcReach-equipped engine drive (pages 78–84).

**Weld with large diameter wire.** The ArcReach SuitCase 12 Heavy Duty model is specifically designed for applications using 3/32-inch cored wire.

## Additional features of ArcReach Smart Feeder

**Delivers excellent synergic RMD® and pulsed MIG welding** up to 200 feet away from the power source with no control cords – twice the distance previously possible. RMD and pulsed MIG welding permits procedures with one wire and one gas to eliminate process switch-over time. RMD and pulsed MIG processes also help reduce weld failures and eliminate backing gas on some stainless and chrome-moly applications.

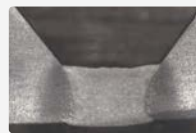

RMD carbon steel



Pulsed MIG stainless

## SuitCase® 12RC

See literature M/6.5

**Standard remote voltage control with a control cord.** For applications where the feeder is within 100 feet of the power source and control cords are acceptable.

\*Additional packages are available – visit [MillerWelds.com](http://MillerWelds.com) or your distributor.

### Heavy industrial

Use with CC/CV (CV only with 12RC), DC power sources. See spec chart below for Smart Feeder requirements.

#### Processes

- MIG (GMAW) ▪ Flux-cored (FCAW)
- RMD and pulsed MIG (GMAW-P) with ArcReach Smart Feeder

#### Suggested power sources

Note: ArcReach SuitCase feeders are compatible with standard power sources and engine-driven welders, but function as standard equipment without remote control capabilities. Full functionality of ArcReach is only available with ArcReach power sources.

#### For ArcReach SuitCase 8 and 12

- Maxstar® 280 Multiprocess (pg 41)
- Dynasty® 280 DX Multiprocess (pg 41)
- XMT® Series (pg 42–45)
- Dimension® 650/650 ArcReach® (pg 46)
- Bobcat™ 200 Air Pak™ (pg 75)
- Bobcat™ Series (pg 76)
- Trailblazer® Series (pg 78, 81)
- Big Blue® Series (pg 81–84)

#### For ArcReach Smart Feeder

- XMT® 350 FieldPro™ (pg 44) (requires three-phase power)
- Trailblazer® Series (ArcReach models only) (pg 78)
- Big Blue® Series (ArcReach models only) (pg 81–84)

#### For SuitCase 12RC (requires power source with 14-pin connector)

- XMT® Series (pg 42)
- Dimension® 650 (pg 46)
- Trailblazer® Series (pg 78, 81)
- Big Blue® Series (pg 81–84)

#### Suggested guns

- Bernard® Guns (pg 25–26)

#### Most popular accessories

- Extension Cables (pg 126) (for SuitCase 12RC only, 1 required)
- Flowmeter Kit 300343
- Shielding Gas Filter 195189

Visit [MillerWelds.com](http://MillerWelds.com) or your distributor for other Miller® options and accessories.

|          | Model                           | Stock Number*   | Input Power  | Input Welding Circuit Rating                          | Wire Feed Speed                                       | Wire Type and Diameter Capacity  | Maximum Spool Size Capacity                                     | Dimensions  | Net Weight       |
|----------|---------------------------------|---|--|---|---|--|---|---|------------------|
| ArcReach | ArcReach SuitCase 8             | (951726) w/Bernard BTB Gun 300 A<br>(951727) w/Bernard S-Gun<br>(951728) w/Bernard Dura-Flux gun<br>(301457) Feeder only                                    | Operates on open-circuit voltage and arc voltage: 14–48 VDC/110 max. OCV             | 330 A at 60% duty cycle                               | 50–780 ipm (1.3–19.8 m/min.) dependent on arc voltage | Solid wire .023–.052 in. (0.6–1.4 mm)<br>Flux-cored .030–5/64 in. (0.8–2.0 mm) | 8 in. (203 mm), 14 lb. (6.4 kg)                                 | H: 12.75 in. (324 mm)<br>W: 7.25 in. (184 mm)<br>D: 18 in. (457 mm) | 28 lb. (13 kg)   |
|          | ArcReach SuitCase 12            | (951729) w/Bernard BTB Gun 300 A<br>(951730) w/Bernard S-Gun<br>(951731) w/Bernard Dura-Flux gun<br>(951732) w/Bernard PipeWorx gun<br>(301456) Feeder only |  | 425 A at 60% duty cycle                               |   | Solid wire .023–.052 in. (0.6–1.4 mm)<br>Flux-cored .030–5/64 in. (0.8–2.0 mm) |   |   |                  |
|          | ArcReach SuitCase 12 Heavy Duty | (301604) Feeder only  | 450 A at 60% duty cycle  | 30–400 ipm (0.8–10.2 m/min.) dependent on arc voltage | Flux-cored .030–3/32 in. (0.8–2.4 mm)                 | 12 in. (305 mm), 45 lb. (20 kg)  | H: 15.5 in. (394 mm)<br>W: 9 in. (229 mm)<br>D: 21 in. (533 mm) | 35 lb. (15.9 kg)  |                  |
|          | ArcReach Smart Feeder           | (951733) w/Bernard PipeWorx gun<br>(300935) Feeder only   | XMT 350 FieldPro connected to three-phase power or an ArcReach-equipped engine drive | 275 A at 60% duty cycle                               | 50–500 ipm (1.3–12.7 m/min.) dependent on arc voltage | .035–.045 in. (0.9–1.1 mm)   | 12 in. (305 mm), 33 lb. (15 kg)                                 | H: 18 in. (457 mm)<br>W: 13 in. (330 mm)<br>D: 21.5 in. (546 mm)    | 50 lb. (23 kg)   |
|          | SuitCase 12RC                   | (951580) w/Bernard BTB Gun 300 A<br>(301121) Feeder only  | 24 VAC, 10 A, 50/60 Hz   | 425 A at 60% duty cycle                               | 50–700 ipm (1.3–17.8 m/min.)                          | Solid wire .023–.052 in. (0.6–1.4 mm)<br>Flux-cored .030–5/64 in. (0.8–2.0 mm) | 12 in. (305 mm), 45 lb. (20 kg)                                 | H: 15.5 in. (394 mm)<br>W: 9 in. (229 mm)<br>D: 21 in. (533 mm)     | 31 lb. (14.1 kg) |

# 20 Series Industrial Bench Feeders

# 70 Series Heavy-Industrial Bench Feeders

Designed for manufacturing, our popular bench feeders are available in two series with multiple models to fit your needs.



20 Series Digital

S-74D

S-74 MPA Plus

D-74 MPA Plus



Bernard BTB Gun 300 A shown.

Feeders **include** a 10 ft. interconnecting cord and are **available** with a Bernard® gun and drive rolls (see chart on page 21). Feeders with BTB Gun 300 A (20 Series) or BTB Gun 400 A (70 Series, two with dual-wire models) come with Centerfire™ contact tips and .035/.045 in. drive rolls.

### 20 and 70 Series Features

| Feature                   | 20 Series |         | 70 Series |     |       |
|---------------------------|-----------|---------|-----------|-----|-------|
|                           | Basic     | Digital | 74S       | 74D | 74MPa |
| Available w/Bernard gun:  |           |         |           |     |       |
| BTB Gun 300 A             | ●         | ●       |           |     |       |
| BTB Gun 400 A             |           |         |           |     | ●     |
| Trigger hold              | ●         | ●       | ●         | ●   | ●     |
| Digital meter(s)          | ●         | ●       | ●         | ●   | ●     |
| Remote voltage control    | ●         | ●       | ●         | ●   | ●     |
| Adjustable run-in control | ●         | ●       | ●         | ●   | ●     |
| Automatic run-in control  |           |         | ●         | ●   | ●     |
| Dual-wire models          |           |         | ●         | ●   | ●     |
| Rotatable drive assembly  |           |         | ●         | ●   | ●     |
| Accu-Mate™                |           |         | ●         | ●   | ●     |
| Preflow/postflow          |           |         |           |     | ●     |
| Spot control              |           |         |           |     | ●     |
| Dual schedule control     |           |         |           |     | ●     |
| Trigger program select    |           |         |           |     | ●     |
| Trigger dual schedule     |           |         |           |     | ●     |
| Sequence control          |           |         |           |     | ●     |
| Locks and limits          |           |         |           |     | ●     |
| Weld programs             |           |         |           |     | 4     |
| Trigger schedule select   |           |         |           |     | ●     |
| Push-pull capability      |           |         |           |     | ●     |
| Synergic pulsed MIG       |           |         |           |     | ●     |
| Profile Pulse™            |           |         |           |     | ●     |

● Standard ● Field option

**Trigger hold** allows the operator to make long welds without having to hold the trigger continuously. Reduces operator fatigue.

**Miller® standard quick-change drive rolls save time.**

**Quick-release drive-roll pressure arm** allows drive roll change without losing spring preload setting.

**Easy loading and threading of welding wire** without having to release the drive roll pressure arm.

**Four gear-driven drive rolls** provide more consistent feeding on larger wire diameters.

**Feeders include a 10-foot 14-pin interconnecting cord and are available with a 15-foot Bernard BTB Gun 300 A (20 Series) or BTB Gun 400 A (70 Series, two with dual-wire models).**

### Additional features for 70 Series feeders

**Available in dual-wire models** which allow two different wire types to be available on one feeder, avoiding downtime from changing spools and drive rolls.

**Toolless rotatable drive assembly** allows operator to rotate the drive housing, allowing a straight path for wire flow.

**Accu-Mate™** properly seats the MIG gun power pin for best feeding performance.

**High-torque permanent-magnet motor, sealed ball bearing gear drive and solid-state speed and brake control** are maintenance free for long life.

## 20 Series (Basic and Digital) See literature M/11.0

**Simple and cost-effective feeders for industrial manufacturing and fabricating.**

**Ideal for most high-duty-cycle applications** requiring day-in/day-out trouble-free operation.

**On-board burnback and motor ramp control** for excellent starting and stopping performance.

**Digital meter (standard on digital model, field option on basic model)** ensures accuracy when presetting and reading actual voltage, amperage and wire feed speed.

**Remote voltage control (standard on digital model, field option on basic model)** at feeder for easier adjustments in the weld cell.

**Adjustable run-in control (standard on digital model, field option on basic model)** for better arc-starting performance on a variety of wires.

## 70 Series (74S and 74D) See literature M/3.0

**Standard, simple feeders for most heavy-industrial applications, with the 74D providing increased accuracy and control of the most common weld parameters.**

**Digital meters (74D models only)** ensure accuracy when presetting and reading actual voltage, amperage and wire feed speed.

**Remote voltage control (standard on 74D, field option on 74S)** allows you to set both voltage and wire feed speed at the feeder, saving time and increasing weld quality because optimal weld parameters are easy to set.

## 70 Series (74 MPa Plus) See literature M/3.0

**Adds features for weld control and programs, plus push-pull aluminum capabilities. Optimized with Invision™ MPa or XMT® MPa power sources.**

**Adjustable run-in control** for improved arc starts.

**Dual schedule control** allows the operator to switch between two preconfigured welding parameters without readjusting the machine, saving time and enhancing quality.

**Trigger schedule select** saves time when switching between two weld settings by simply tapping gun trigger.

**Trigger program select** provides the ability to access any of the four active programs.

**Sequence control** gives the operator the ability to adjust all of the welding parameters: preflow, run-in, weld time, crater, burnback and postflow.

**Locks and limits** for restricting or limiting operator adjustments, such as voltage and wire feed speed parameters.

**Four weld program memories** allow operators to recall up to four previously used processes and their weld settings.

**Push-pull capability** provides consistent, versatile and dependable aluminum wire feeding over greater distances.

**Recommended aluminum solution.**

Dedicated XR Plus guns (gooseneck and pistol grip) work with MPa Plus feeders to coordinate wire feed speed of the gun and the feeder. This provides optimized aluminum feeding and welding performance. See chart below for gun models and stock numbers.



### Additional features when used with Invision MPa or XMT MPa power sources

**Synergic pulsed MIG.** As wire speed increases/decreases, pulse parameters also increase/decrease to match the right amount of power needed, reducing the need to make additional adjustments.

**Profile Pulse™** provides TIG appearance with MIG simplicity and productivity. Achieve “stacked dimes” without gun manipulation. Profile Pulse frequency can be changed to increase or decrease the spacing between the ripple pattern to achieve the desired weld appearance.



**Industrial** ● 20 Series  
**Heavy Industrial** ● 70 Series

**CVDC** Use with CV, DC power sources.

#### Processes

- MIG (GMAW) ▪ Flux-cored (FCAW)
- Pulsed MIG (GMAW-P) with MPa Plus feeder and optional MPa power source

#### Suggested power sources

- Invision™ MPa Series (pg 14)
- XMT® Series (pg 42-45)
- Dimension™ 650/650 ArcReach® (pg 46)

#### Suggested guns

- Bernard® Guns (pg 25-26)
- XR-Aluma-Pro™ Plus and XR™-Pistol Plus (see chart below)

#### Most popular accessories

- Feeder Cart 142382 (pg 118)
- Extension Cables (pg 126)
- Spool Adapter 047141 (pg 126)
- Turntable Assembly 146236 (pg 126)
- Wire Straightener (pg 126)
- Field Kits for 20 Series Basic
  - 301513 Digital meter and remote voltage control
  - 301515 Run-in control
- Field Kits for 70 Series (74S)
  - 194988 Remote voltage control for single-wire models
  - 194991 Remote voltage control for dual-wire models
- Hanging Bail 058435
- Spool Covers
  - 057607 For 20 and 70 Series single-wire models and left side of dual-wire models
  - 090389 For right side of dual-wire models
- Wire Reel Assembly 108008
- Remote configurations are available – see page 22 and literature M/3.0

Visit [MillerWelds.com](http://MillerWelds.com) or your distributor for other Miller® options and accessories.

\*Additional packages are available – visit [MillerWelds.com](http://MillerWelds.com) or your distributor. \*\*Requires gun wire kit (230708) to run 1/16 in. (1.6 mm) wire.

| Model   | Stock Number*   | Input Power             |                       | Wire Feed Speed               | Wire Type and Diameter Capacity  | Maximum Spool Size Capacity                                   | Dimensions  |                            | Net Weight |
|---|---|-------------------------|-----------------------|-------------------------------|--|---|---|----------------------------|------------|
|   |   | 24 VAC, 3.5 A, 50/60 Hz | 10 A, 50/60 Hz        |                               |  |   | H:  | W:                         |            |
| <b>20 Series</b>  | <b>Basic (301499)</b> Feeder only<br><b>Basic (951779)</b> w/Bernard BTB Gun 300 A<br><b>Digital (301499001)</b> Feeder only<br><b>Digital (951780)</b> w/Bernard BTB Gun 300 A | 24 VAC, 3.5 A, 50/60 Hz |                       | 75-750 ipm (1.9-19 m/min.)    | .023-5/64 in. (0.6-2.0 mm)   | 60 lb. (27 kg) coil with optional wire reel assembly (108008) | H: 16 in. (406 mm)<br>W: 12.375 in. (314 mm)<br>D: 27.875 in. (708 mm)  | 46 lb. (21 kg)             |            |
| <b>70 Series</b> (Single-wire models)                     | <b>S-74S (951196)</b> w/Bernard BTB Gun 400 A<br><b>S-74D (951198)</b> w/Bernard BTB Gun 400 A<br><b>S-74 MPa Plus (951291)</b> w/Bernard BTB Gun 400 A                         | 24 VAC, 10 A, 50/60 Hz  |                       | 50-780 ipm (1.3-19.8 m/min.)  | .023-5/64 in. (0.6-2.0 mm)<br><b>MPa Plus model</b><br><b>Hard wire</b> .023-5/64 in. (0.6-2.0 mm)<br><b>Aluminum**</b> .035-1/16 in. (0.9-1.6 mm) | 60 lb. (27 kg) coil with optional wire reel assembly (108008) | H: 14 in. (356 mm)<br>W: 12.5 in. (318 mm)<br>D: 28 in. (711 mm)        | 48 lb. (21.2 kg)           |            |
| <b>70 Series</b> (Dual-wire models)                       | <b>D-74S (951203)</b> w/Bernard BTB Gun 400 A<br><b>D-74D (951204)</b> w/Bernard BTB Gun 400 A<br><b>D-74 MPa Plus (951292)</b> w/Bernard BTB Gun 400 A                         |                         |                       |                               |  |   | H: 14 in. (356 mm)<br>W: 21 in. (533 mm)<br>D: 35 in. (889 mm)          | 87 lb. (39.5 kg)           |            |
| <b>Optional Push-Pull Gun</b> (For MPa Plus feeders only) |   | <b>Cable Length</b>     |                       | <b>Welding Current Rating</b> | <b>Wire Feed Speed</b>   | <b>Wire Type and Diameter Capacity</b>                        | <b>Dimensions</b>   | <b>Gun Only Net Weight</b> |            |
|   |   | <b>15 ft. (4.6 m)</b>   | <b>25 ft. (7.6 m)</b> |                               |  |   |   |                            |            |
|   | <b>XR-Aluma-Pro Plus</b> (Air-cooled)   | <b>(301575)</b>         | <b>(301574)</b>       | 300 A at 100% duty cycle      | 70-780 ipm (1.8-19.8 m/min.)   | <b>Aluminum**</b> .030-1/16 in. (0.8-1.6 mm)                  | H: 5 in. (127 mm)<br>W: 2.5 in. (64 mm)<br>L: 17 in. (432 mm)           | 2.5 lb. (1.1 kg)           |            |
|   | <b>XR-Aluma-Pro Plus</b> (Water-cooled)   | <b>(301576)</b>         | <b>(301577)</b>       | 400 A at 100% duty cycle      |  |   |   | 2.9 lb. (1.3 kg)           |            |
|   | <b>XR-Pistol Plus</b> (Air-cooled)  | <b>(300753)</b>         | <b>(300754)</b>       | 200 A at 100% duty cycle      | 70-780 ipm (1.8-19.8 m/min.)   | <b>Aluminum**</b> .030-1/16 in. (0.8-1.6 mm)                  | H: 7.375 in. (187 mm)<br>W: 1.875 in. (48 mm)<br>L: 10.625 in. (270 mm) | 2.2 lb. (1 kg)             |            |
|   | <b>XR-Pistol Plus</b> (Water-cooled)  | –                       | <b>(300757)</b>       | 400 A at 100% duty cycle      |  |   |   | 2.4 lb. (1.1 kg)           |            |

## 70 Series Swingarc™ See literature M/13.11

Swingarc boom-mounted wire feeders bring an extra dimension of flexibility and efficiency to weld stations dealing with large weldments, or wherever operator mobility is required.

Models include a 10 ft. 14-pin interconnecting cord, Bernard® BTB Gun 400 A (two with dual-wire models) with Centerfire™ contact tips, and .035/.045 in. drive rolls.

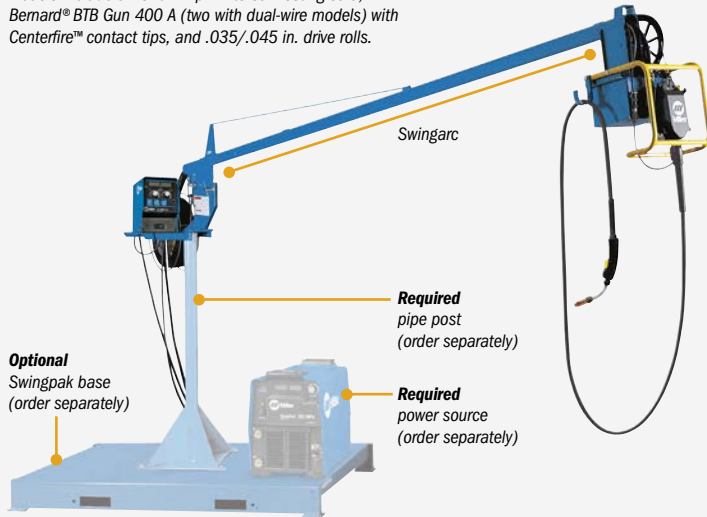

Single- and dual-wire models with 12- or 16-foot booms are sized to accommodate a variety of weld cell layouts (24- or 32-foot diameter work area).

Counterbalance design makes it easy to position boom and 360-degree rotation and 60-degree lift angle maximize work area.

In-boom cable routing organizes hoses and cables for a cleaner work environment.

MPa Plus Swingarc. Optimized for the Invision™ MPa and XMT® MPa power sources and available in single- or dual-wire models in two boom lengths.

### Heavy Industrial ● CV DC

Use with CV, DC power sources.

#### Processes

- MIG (GMAW) ▪ Flux-cored (FCAW)
- Pulsed MIG (GMAW-P) with MPa Plus control and optional MPa power source

#### Suggested power sources/guns

- Same as 70 Series

#### Most popular accessories

- Swingpak™ Base 183997
  - Pipe Post with 18 in. Base 149838 4 ft. 149839 6 ft.
  - Single/Dual Spool Carrier for 6 ft. Pipe Post 300352
- Pipe post not included – carrier is designed to put spool hub assembly at 36 inches from base for easier wire spool installation



Visit [MillerWelds.com](http://MillerWelds.com) or your distributor for other Miller® options and accessories.

| Model               | Single-Wire Model Stock Numbers   | Dual-Wire Model Stock Numbers   | Input Power            | Wire Feed Speed              | Wire Diameter Capacity     | Maximum Spool Size Capacity                                   | Net Weight with Feeder  |
|---------------------|---|---|------------------------|------------------------------|----------------------------|---|---|
| 12 ft. (3.7 m) Boom | SS-74D12 (951526) w/S-74D<br>SS-74 MPa Plus-12 (951438) w/S-74 MPa Plus | DS-74D12 (951535) w/D-74D<br>DS-74 MPa Plus-12 (951441) w/D-74 MPa Plus | 24 VAC, 10 A, 50/60 Hz | 50-780 ipm (1.3-19.8 m/min.) | .023-5/64 in. (0.6-2.0 mm) | 60 lb. (27 kg) coil with optional wire reel assembly (108008) | Single-wire model: 160 lb. (73 kg)<br>Dual-wire model: 207 lb. (94 kg)  |
| 16 ft. (4.9 m) Boom | SS-74D16 (951527) w/S-74D<br>SS-74 MPa Plus-16 (951439) w/S-74 MPa Plus | DS-74D16 (951536) w/D-74D<br>DS-74 MPa Plus-16 (951442) w/D-74 MPa Plus |                        |                              |                            |   | Single-wire model: 210 lb. (95 kg)<br>Dual-wire model: 280 lb. (127 kg) |

## 70 Series Remote Configurations See literature M/3.0

Remote wire feeder control box and wire drive assembly for non-Miller boom applications.



Note: MPa Plus wire drive motor assemblies and control cables are only for use with MPa Plus control boxes.

- Single-wire control box**
- 300881** S-74S
  - 300882** S-74D
  - 300738** S-74 MPa Plus

- Motor control cable**
- Standard: 11 conductor
  - MPa Plus: 14 conductor

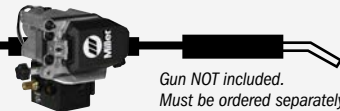

- Wire drive motor assembly**
- 300904** Standard left-hand drive
  - 300740** MPa Plus left-hand drive
- MPa Plus drive can be used with push-only guns, OR XR-Aluma-Pro™ Plus and XR™-Pistol Plus push-pull guns.

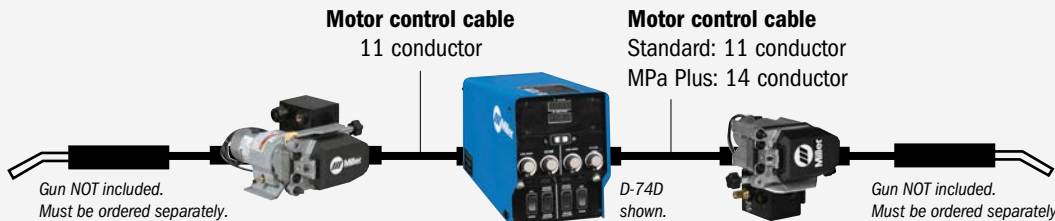

- Push-only wire drive motor assembly**
- 300741001** Standard right-hand drive
  - 300741** MPa Plus right-hand drive

- Dual-wire control box**
- 300886** D-74S
  - 300887** D-74D
  - 300739** D-74 MPa Plus

- Wire drive motor assembly**
- 300904** Standard left-hand drive
  - 300740** MPa Plus left-hand drive
- MPa Plus drive can be used with push-only guns, OR XR-Aluma-Pro™ Plus and XR™-Pistol Plus push-pull guns.

### Heavy Industrial ● CV DC

Use with CV, DC power sources.

#### Processes

- MIG (GMAW) ▪ Flux-cored (FCAW)
- Pulsed MIG (GMAW-P) with MPa Plus control and optional MPa power source

#### Suggested power sources/guns

- Same as 70 Series

#### Most popular accessories

- Motor Control Cable (11 conductor) 254935010 10 ft. (3 m) 254935025 25 ft. (7.6 m) For push-only gun configurations
- MPa Plus Motor Control Cable (14 conductor) 254864010 10 ft. (3 m) 254864025 25 ft. (7.6 m) 254864050 50 ft. (15.2 m) For MPa Plus configurations only – single-wire or left side of dual-wire



- Feeder Base 195369
- For use with spooled wire
- Visit [MillerWelds.com](http://MillerWelds.com) or your distributor for other Miller® options and accessories.



For more detailed information, visit

MillerWelds.com/guns-torches

## Product Guide

|   | Page | Class | MIG | Pulsed MIG | Flux-cored* | Hard | Wire Types |           |       | Wire Diameter Capacity | Available Cable Lengths   | Typical Applications                                       |                                       |          |
|---|------|-------|-----|------------|-------------|------|------------|-----------|-------|------------------------|---|--|---------------------------------------|----------|
|   |      |       |     |            |             |      | Flux-cored |           | Alum. |                        |   |  |                                       |          |
|   |      |       |     |            |             |      | Dual-shld  | Self-shld |       |                        |   |  |                                       |          |
| MIGmatic™ M-100 MIG Gun                                       | 23   | ●     | ●   | ●          | ●           | ●    | ●          | ●         | ● CV* | ●                      | .023-.045 in. (0.6-1.2 mm)  | 10 ft.   | Light industrial steel fabrication    | Steel    |
| MIGmatic™ M-150 MIG Guns                                      | 23   | ●     | ●   | ●          | ●           | ●    | ●          | ●         | ● CV* | ●                      | .023-.045 in. (0.6-1.2 mm)  | 10, 12 or 15 ft.   | Light industrial steel fabrication    |          |
| MDX™-100 MIG Gun  | 24   | ●     | ●   | ●          | ●           | ●    | ●          | ●         | ● CV* | ●                      | .023-.045 in. (0.6-1.2 mm)  | 10 ft.   | Light industrial steel fabrication    |          |
| MDX™-250 MIG Guns   | 24   | ●     | ●   | ●          | ●           | ●    | ●          | ●         | ● CV* | ●                      | .023-.045 in. (0.6-1.2 mm)  | 10, 12 or 15 ft.   | Industrial steel fabrication          |          |
| MDX™-250 EZ-Select™ MIG Guns                                  | 24   | ●     | ●   | ●          | ●           | ●    | ●          | ●         | ● CV* | ●                      | .023-.045 in. (0.6-1.2 mm)  | 15 ft.   | Industrial steel fabrication          |          |
| Bernard® BTB MIG Guns   | 25   | ●     | ●   | ●          | ●           | ●    | ●          | ●         | ● CV* | ●                      | .023-1/8 in. (0.6-3.2 mm)   | 10, 15, 20, or 25 ft.                                      | Heavy industrial steel fabrication    |          |
| Bernard® Clean Air™ Fume Extraction Guns with Straight Handle | 26   | ●     | ●   | ●          | ●           | ●    | ●          | ●         | ● CV* | ●                      | .023-1/8 in. (0.6-3.2 mm)   | 8, 10, 12, 15, 20, or 25 ft.                               | Heavy industrial steel fabrication    |          |
| Bernard® Clean Air™ Fume Extraction Guns with Curved Handle   | 26   | ●     | ●   | ●          | ●           | ●    | ●          | ●         | ● CV* | ●                      | .023-5/64 in. (0.6-2.0 mm)  | 8, 10, 12, 15, 20, or 25 ft.                               | Heavy industrial steel fabrication    |          |
| Bernard® Dura-Flux™ Guns with Fixed Liner                     | 26   | ●     | ●   | ●          | ●           | ●    | ●          | ●         | ● CV* | ●                      | 1/16-3/32 in. (1.6-2.4 mm)  | 8, 10, 12, 15, 20, or 25 ft.                               | Heavy industrial steel fabrication    |          |
| Bernard® Dura-Flux™ Guns with Replaceable Liner               | 26   | ●     | ●   | ●          | ●           | ●    | ●          | ●         | ● CV* | ●                      | .045-5/64 in. (1.2-2.0 mm)  | 8, 10, 12, 15, 20, or 25 ft.                               | Heavy industrial steel fabrication    |          |
| Spoolmate™ Spool Guns   | 27   | ●     | ●   | ●          | ●           | ●    | ●          | ●         | ●     | ●                      | 100/200/3035 models:<br>.023-.035 in. (0.6-0.9 mm)<br>150 model: .030-.035 in. (0.8-0.9 mm) | 100 model: 12 ft.<br>150/200/3035 models: 20 ft.           | Light industrial aluminum fabrication | Aluminum |
| Spoolmatic® Spool Guns  | 28   | ●     | ●   | ●          | ●           | ●    | ●          | ●         | ● CV* | ●                      | .030-1/16 in. (0.8-1.6 mm)  | 15 or 30 ft.   | Industrial aluminum fabrication       |          |
| XR-Aluma-Pro™ Lite Push-Pull Gun                              | 29   | ●     | ●   | ●          | ●           | ●    | ●          | ●         | ●     | ●                      | .030-.047 in. (0.8-1.2 mm)  | 25 ft.   | Industrial aluminum fabrication       |          |
| XR-Aluma-Pro™ Push-Pull Guns                                  | 29   | ●     | ●   | ●          | ●           | ●    | ●          | ●         | ●     | ●                      | .030-1/16 in. (0.8-1.6 mm)  | 15, 25 or 35 ft.   | Heavy industrial aluminum fabrication |          |
| XR™-Pistol Push-Pull Guns                                     | 29   | ●     | ●   | ●          | ●           | ●    | ●          | ●         | ●     | ●                      | .030-1/16 in. (0.8-1.6 mm)  | XR-Pistol: 15 or 30 ft.<br>XR-Pistol-Pro: 15, 25 or 35 ft. | Heavy industrial aluminum fabrication |          |

### Product Key

Class: ● Light industrial ● Industrial ● Heavy industrial Capability: ● Designed for this process ● Capable of this process

\*Certain self-shielded wires require CV output. Miller recommends a CV power source whenever possible.

# MIGmatic™ M-Series MIG Guns

See literature AY/15.0

An ideal match for Miller® all-in-one MIG machines or other Miller® wire feeders.



**Three-piece nozzle construction** extends nozzle life by reducing wear and helps prevent rocking of nozzle on contact tip adapter.

**Interchangeable contact tips and monocoil liners** help reduce parts inventory.

**Brass contact tip adapter** helps prevent galling, sticking and stripping of threads.

**Steel spring strain relief** protects power cable from wear and helps prevent liner from kinking, allowing better wire feedability.

### Light Industrial ●

#### Processes

- MIG (GMAW) ■ Flux-cored (FCAW)

#### Suggested power sources

- Millermatic® 141/211 (M-100/M-150) (pg 7)
- Multimatic® 200 (M-150) (pg 37)
- Multimatic® 215 (M-100/M-150) (pg 37)

#### Most popular accessories

- MIGmatic M-Series Consumable Kits (pg 121)
  - 234607 .023 in. (0.6 mm)
  - 234608 .030 in. (0.8 mm)
  - 234609 .035 in. (0.9 mm)
- MIGmatic M-Series Guns AccuLock™ Conversion Kit 1880269
  - Allows M-100 and M-150 MIG guns to upgrade to AccuLock™ MDX™ nozzles and tips (see pg 24)

Visit MillerWelds.com or your distributor for other Miller® options and accessories.

| Model | Stock Number | Cable Length   | Rated Output | Rated Duty Cycle                                  | Wire Diameter Capacity     | Gun Only Net Weight |
|-------|--------------|----------------|--------------|---|----------------------------|---------------------|
| M-100 | (248282)     | 10 ft. (3 m)   | 100 A        | 100% with CO <sub>2</sub> gas, 60% with mixed gas | .023-.045 in. (0.6-1.2 mm) | 3.2 lb. (1.5 kg)    |
| M-150 | (249039)     | 10 ft. (3 m)   | 150 A        | 100% with CO <sub>2</sub> gas, 60% with mixed gas | .023-.045 in. (0.6-1.2 mm) | 4.4 lb. (2.0 kg)    |
|       | (249040)     | 12 ft. (3.7 m) |              |   |                            | 4.7 lb. (2.1 kg)    |
|       | (249041)     | 15 ft. (4.6 m) |              |   |                            | 6.0 lb. (2.7 kg)    |

# MDX™ Series MIG Guns

See literature AY/15.5

An ideal match for Miller® all-in-one MIG machines or other Miller® wire feeders.



**Durable, ergonomic handle** features rubber overmolding for improved grip and rear swivel to reduce welder fatigue.

**AccuLock™ consumables** provide long life and superior wire feeding. See below for more information.

**Pulse welding capable** due to increased copper in the gun cable which ensures reliable performance with CV and pulse waveforms (MDX-250/MDX-250 EZ-Select only).

**EZ-Select™ function** allows you to conveniently select from up to four weld programs by tapping the MIG gun trigger rather than walking back to the machine. Lights on handle indicate weld program selected (MDX-250 EZ-Select only).



| Model             | Stock Number | Cable Length   | Rated Output | Rated Duty Cycle                                  | Standard Wire Size         | Standard Consumables |
|-------------------|--------------|----------------|--------------|---|----------------------------|----------------------|
| MDX-100           | (1770028)    | 10 ft. (3 m)   | 100 A        | 100% with CO <sub>2</sub> gas, 60% with mixed gas | .030-.035 in. (0.8-0.9 mm) | AccuLock MDX         |
| MDX-250           | (1770035)    | 10 ft. (3 m)   | 250 A        | 100% with CO <sub>2</sub> gas, 60% with mixed gas | .030-.035 in. (0.8-0.9 mm) | AccuLock MDX         |
|                   | (1770036)    | 12 ft. (3.7 m) | 250 A        | 100% with CO <sub>2</sub> gas, 60% with mixed gas | .030-.035 in. (0.8-0.9 mm) | AccuLock MDX         |
|                   | (1770037)    | 15 ft. (4.6 m) | 250 A        | 100% with CO <sub>2</sub> gas, 60% with mixed gas | .030-.035 in. (0.8-0.9 mm) | AccuLock MDX         |
|                   | (1770038)    | 15 ft. (4.6 m) | 250 A        | 100% with CO <sub>2</sub> gas, 60% with mixed gas | .035-.045 in. (0.9-1.2 mm) | AccuLock MDX         |
|                   | (1770041)    | 10 ft. (3 m)   | 250 A        | 100% with CO <sub>2</sub> gas, 60% with mixed gas | .035-.045 in. (0.9-1.2 mm) | AccuLock S           |
|                   | (1770042)    | 12 ft. (3.7 m) | 250 A        | 100% with CO <sub>2</sub> gas, 60% with mixed gas | .035-.045 in. (0.9-1.2 mm) | AccuLock S           |
| MDX-250 EZ-Select | (1770043)    | 15 ft. (4.6 m) | 250 A        | 100% with CO <sub>2</sub> gas, 60% with mixed gas | .035-.045 in. (0.9-1.2 mm) | AccuLock S           |
|                   | (1770046)    | 15 ft. (4.6 m) | 250 A        | 100% with CO <sub>2</sub> gas, 60% with mixed gas | .035-.045 in. (0.9-1.2 mm) | AccuLock S           |
|                   | (1770047)    | 15 ft. (4.6 m) | 250 A        | 100% with CO <sub>2</sub> gas, 60% with mixed gas | .030-.035 in. (0.8-0.9 mm) | AccuLock MDX         |

## AccuLock™ MDX™ Consumables

See literature AY/15.5

**Flawless wire feeding path.** Front-loading liner is locked (without set screws) and concentrically aligned with both the contact tip and power pin.

**Error-proof liner trimming** ensures accurate replacement every time – no measuring required!

**Maximize electrical conductivity and tip life.** Tapered mating surface between the contact tip and gas diffuser locks tips in place for optimal performance.

**Upgrade to AccuLock S consumables** for increased durability and longer life when guns are used in pulsed welding or more industrial applications. See page 25 for more information.



## MDX Series MIG Guns Consumable Kits



### For MDX-100 with AccuLock MDX

- 1880272** .023 in (0.6 mm)
- 1880273** .030 in (0.8 mm)
- 1880274** .035 in (0.9 mm)

### For MDX-250 with AccuLock MDX

- 1880275** .030 in (0.8 mm)
- 1880276** .035 in (0.9 mm)
- 1880277** .045 in (1.2 mm)

### For MDX-250 with AccuLock S

- 1880278** .035 in (0.9 mm)
- 1880279** .045 in (1.2 mm)

Kits include ten contact tips, one nozzle, one diffuser, and a consumable storage box. Both kits for MDX-250 gun also include one neck insulator.

Light industrial ● MDX-100  
Industrial ● MDX-250/250 EZ-Select

### Processes

- MIG (GMAW) ■ Flux-cored (FCAW)
- Pulsed MIG (GMAW-P) with MDX-250/250 EZ-Select

### Suggested power sources

#### For MDX-100

- Millermatic® 141/211 (pg 7)
- Multimatic® 215 (pg 37)
- Multimatic® 220 AC/DC (pg 38)

#### For MDX-250

- Millermatic® 252 (pg 8)
- Millermatic® 255 (pg 9)
- Multimatic® 200 (pg 37)
- Multimatic® 235 (pg 39)
- Multimatic® 255 (pg 40)

#### For MDX-250 EZ-Select

- Millermatic® 255 (pg 9)
- Multimatic® 255 (pg 40)

### Most popular consumables

#### AccuLock Consumables

##### Liners (inches)

- LM1A-10** .023-.025, 10 ft. length
- LM2A-10** .030-.035, 10 ft. length
- LM3A-10** .035-.045, 10 ft. length
- LM1A-12** .023-.025, 12 ft. length
- LM2A-12** .030-.035, 12 ft. length
- LM3A-12** .035-.045, 12 ft. length
- LM1A-15** .023-.025, 15 ft. length
- LM2A-15** .030-.035, 15 ft. length
- LM3A-15** .035-.045, 15 ft. length

##### Diffusers

- D-M100** MDX-100
- D-M250** MDX-250
- D-MA250M** MDX-250 AccuLock S conversion

##### MDX-100 Nozzles (inches)

- NS-M1200B** 1/2 ID, flush, brass
- NS-M1200C** 1/2 ID, flush, copper
- NS-MFLX** Gasless nozzle

##### MDX-250 Nozzles (inches)

- AccuLock MDX**
- N-M1200C** 1/2 ID, flush, copper
- N-M1218C** 1/2 ID, 1/8 rec., copper
- N-M5800C** 5/8 ID, flush, copper
- N-M5818C** 5/8 ID, 1/8 rec., copper
- N-M58XC** 5/8 ID, 1/8 ext., copper

##### AccuLock S

- N-A5800CM** 5/8 ID, flush, copper
- N-A5818CM** 5/8 ID, 1/8 rec., copper
- N-A5814CM** 5/8 ID, 1/4 rec., copper

##### Contact Tips (inches)

##### AccuLock MDX

- T-M023** .023
- T-M030** .030
- T-M035** .035
- T-M045** .045
- T-M047** 3/64

##### AccuLock S

- T-A023CHM** .023
- T-A030CHM** .030
- T-A035CHM** .035
- T-A039CHM** .039
- T-A045CHM** .045

Visit [MillerWelds.com](http://MillerWelds.com) or your distributor for other Miller® options and accessories.

# Bernard® Semi-Automatic Guns

Miller offers rugged and reliable Bernard welding guns that have been customized to match the performance of many of its industrial wire feeders and power sources.

## BTB Air-Cooled MIG Guns See Bernard literature SP-BTB

Fully configurable BTB MIG guns help keep your skilled welders comfortable while also increasing their productivity.



Choose from a variety of necks, handles and trigger styles to optimize welder ergonomics and weld access, then standardize with a single line of consumables to simplify maintenance and contain costs. **See chart below for a pre-configured BTB MIG gun or visit MillerWelds.com to view a complete list. Configure your BTB MIG gun by visiting Tregaskiss.com/ConfigureMyGun**

All guns in chart come with a Miller® power pin and a Universal Conventional liner except:  
\*Comes with a Miller® power pin and a QUICK LOAD® liner AutoLength™ system.

| Stock Number | Amperage | Cable Length                   | Handle                | Trigger  | Neck               | Consumables         | Wire Size         |
|--------------|----------|--------------------------------|-----------------------|----------|--------------------|---------------------|-------------------|
| Q3015AE8XMC  | 300      | 15 ft. (4.6 m) Hytrel® polymer | B Series small curved | Standard | Rotatable med. 45° | Centerfire™ (flush) | .045 in. (1.2 mm) |
| Q3015AE8EMC  | 300      | 15 ft. (4.6 m) Hytrel® polymer | B Series small curved | Standard | Rotatable med. 45° | Centerfire™         | .045 in. (1.2 mm) |
| Q3015TE5EMC  | 300      | 15 ft. (4.6 m) Hytrel® polymer | O Series small curved | Standard | Rotatable med. 45° | Quik Tip™           | .045 in. (1.2 mm) |
| Q3015AE8HMC  | 300      | 15 ft. (4.6 m) Hytrel® polymer | B Series small curved | Standard | Rotatable med. 45° | Centerfire™         | .052 in. (1.3 mm) |
| Q4015AE8EMC  | 400      | 15 ft. (4.6 m) Hytrel® polymer | B Series curved       | Standard | Rotatable med. 45° | Centerfire™         | .045 in. (1.2 mm) |
| Q4015TE5EMC  | 400      | 15 ft. (4.6 m) Hytrel® polymer | O Series small curved | Standard | Rotatable med. 45° | Quik Tip™           | .045 in. (1.2 mm) |
| Q4015VS3EML* | 400      | 15 ft. (4.6 m) Hytrel® polymer | C Series straight     | Standard | Fixed med. 60°     | TOUGH LOCK®         | .045 in. (1.2 mm) |
| Q4015MS3EMC  | 400      | 15 ft. (4.6 m) Hytrel® polymer | T Series straight     | Standard | Fixed med. 60°     | TOUGH LOCK®         | .045 in. (1.2 mm) |
| Q4015AE8HMC  | 400      | 15 ft. (4.6 m) Hytrel® polymer | B Series curved       | Standard | Rotatable med. 45° | Centerfire™         | .052 in. (1.3 mm) |
| Q4020MF8HMC  | 400      | 20 ft. (6.1 m) Hytrel® polymer | T Series straight     | Standard | Rotatable med. 60° | Centerfire™         | .052 in. (1.3 mm) |
| Q4015AE8IMC  | 400      | 15 ft. (4.6 m) Hytrel® polymer | B Series curved       | Standard | Rotatable med. 45° | Centerfire™         | 1/16 in. (1.6 mm) |
| Q4025MF8IMC  | 400      | 25 ft. (7.6 m) Hytrel® polymer | T Series straight     | Standard | Rotatable med. 60° | Centerfire™         | 1/16 in. (1.6 mm) |
| S4025MF8IMC  | 400      | 25 ft. (7.6 m) steel monocoil  | T Series straight     | Standard | Rotatable med. 60° | Centerfire™         | 1/16 in. (1.6 mm) |
| Q4015MS3IMC  | 400      | 15 ft. (4.6 m) Hytrel® polymer | T Series straight     | Standard | Fixed med. 60°     | TOUGH LOCK®         | 1/16 in. (1.6 mm) |

## AccuLock™ S Consumables See Bernard literature SP-ALS

### Load and lock for flawless wire feeding

- Shorten your troubleshooting list by reducing liner misalignment and gaps
- Error-proof your liner installation – no measuring required!

### Reduce parts, increase accuracy

- Use AccuLock S consumables on both your Bernard BTB and Miller® MDX-250 MIG guns (see page 24) to simplify inventory and reduce replacement errors

Note: To convert your BTB MIG gun part number from the chart above to a configuration with AccuLock S consumables, change the Consumables selection to a "4" and change the Liner Type selection to an "A". For example, Q4015AE8EMC becomes Q4015AE4EMA. Additional BTB MIG gun configurations are available through Bernard and can be configured online at Tregaskiss.com/ConfigureMyGun.



### Heavy industrial ●

#### Processes

- MIG (GMAW) ▪ Flux-cored (FCAW)
- Pulsed MIG (GMAW-P)

#### Duty cycle ratings

- 100% with CO<sub>2</sub>
- 60% with mixed gases

#### Suggested feeders

- Intellx™ Feeders (pg 13)
- Continuum™ Feeder (pg 15)
- SuitCase® Series (pg 18)
- 20 and 70 Series Feeders (pg 20–22)

#### Suggested power source

- Millermatic® 350P (pg 10)

### Most popular consumables

#### Centerfire™ Consumables

##### Diffusers (amps)

- DS-1 200, 300, small
- D-1 400, 500, 600, large

##### Brass Nozzles (inches)

- NS-1218B 1/2 ID, 1/8 rec., small

##### Copper Nozzles (inches)

- NS-5818C 5/8 ID, 1/8 rec., small
- N-5818C 5/8 ID, 1/8 rec., large
- N-5814C 5/8 ID, 1/4 rec., large
- N-3414C 3/4 ID, 1/4 rec., large

##### Contact Tips (inches)

- T-035 .035
- T-045 .045
- T-052 .052
- T-062 1/16

#### Quik Tip™ Consumables

##### Diffusers (amps)

- D118Q 200, 300, 400
- D114Q 500, 600

##### Plated Copper Nozzles (inches)

- N1C58Q 5/8 ID
- N1C34HQ 3/4 ID, HD

##### Contact Tips (inches)

- T1035 .035
- T1045 .045

#### TOUGH LOCK® Consumables

##### Diffusers (amps)

- 404-18-25 200, 300, 400 SD
- 404-26-25 300, 400, 500, 600 HD

##### Copper Nozzles (inches)

- 401-4-62 5/8 ID, 1/8 rec., SD
- 401-6-62 5/8 ID, 1/8 rec., HD
- 401-5-62 5/8 ID, 1/4 rec., HD
- 401-5-75 3/4 ID, 1/4 rec., HD

##### Contact Tips (inches)

- 403-14-35-25 .035 SD
- 403-20-35-25 .035 HD
- 403-14-45-25 .045 SD
- 403-20-45-25 .045 HD
- 403-20-52-25 .052 HD
- 403-20-116-25 1/16 HD

Visit Tregaskiss.com or your distributor for additional Bernard consumable options.

For more detailed information, visit [Tregaskiss.com](http://Tregaskiss.com)



# Bernard® Semi-Automatic Guns

Industrial-duty fume extraction and flux-cored welding solutions built for the way you weld.



Straight handle  
(shown with optional  
short nozzle shroud)

Curved handle

## Clean Air™ Fume Extraction MIG Guns

See Bernard literature SP-CLA

**Maintaining a clean working environment is important and Bernard understands the need for a reliable fume extraction solution. Extract fumes at the weld bead using either of our two models and a FILTAIR® fume extractor.**

### Clean Air straight handle gun

- Available in 300-, 400-, 500- and 600-amp models
- Compatible with Centerfire, Quik Tip and TOUGH LOCK consumables
- Ergonomic, lightweight handle with rear swivel improves operator comfort

### Clean Air curved handle gun

- Available in 300- and 400-amp models
- Compatible with Centerfire, Quik Tip and TOUGH LOCK consumables
- Small lightweight handle maximizes maneuverability and comfort



Fixed power  
cable liner

Replaceable  
power cable liner

## Dura-Flux™ Self-Shielded Flux-Cored Guns

See Bernard literature SP-DF

**For structural steel applications, bridge construction and heavy equipment repair, Bernard offers two types of 350-amp self-shielded flux-cored guns.**

### Dura-Flux gun with fixed power cable liner

- Ultra-heavy-duty steel monocoil power cable is highly resistant to kinking
- Centerfire consumables are easy to use and high performing, providing better arc starts, less spatter and more consistent welds

### Dura-Flux gun with replaceable power cable liner

- Replaceable power cable liner allows quick and easy power cable maintenance
- Quik Tip consumables provide excellent heat transfer and electrical conductivity

## Bernard® Welding Consumables (cutaways shown)

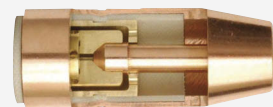

### Centerfire™ consumables

See Bernard literature SP-CFC

- Drop-in contact tip (no tools required to replace tip or nozzle) means quick changeover and reduced downtime
- Spatter shield within nozzle holds tip in place, protects diffuser and directs gas evenly with reduced turbulence
- Diffuser mates securely with contact tip for better conductivity



### Quik Tip™ consumables

See Bernard literature SP-QTC

- A quick twist is all it takes to install contact tips
- Threaded taper lock increases tip life and allows excellent heat transfer and electrical conductivity
- Fixed contact tip position for repeatability and consistent quality welds

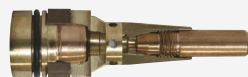

### TOUGH LOCK® consumables

See Bernard literature SP-TLC

- Dual taper technology keeps consumables locked from tip to neck for improved weld consistency, positive electrical conductivity and maximized heat dissipation
- Consumables run cooler, improving performance and extending life



For more detailed information, visit [Tregaskiss.com](http://Tregaskiss.com)



## Heavy industrial ●

### Processes

- MIG (GMAW) ▪ Flux-cored (FCAW)
- Pulsed MIG (GMAW-P)

### Duty cycle ratings

- 100% with CO<sub>2</sub>
- 60% with mixed gases

### Suggested feeders

- Intelli™ Feeders (pg 13)
- Continuum™ Feeder (pg 15)
- SuitCase® Series (pg 18)
- 20 and 70 Series Feeders (pg 20-22)

### Suggested power source

- Millermatic® 350P (pg 10)

### Suggested fume extractor

- FILTAIR® 130 (pg 103)

## Most popular consumables

### Centerfire™ Consumables

#### Diffusers (amps)

**DS-1** 300, small

**D-1** 400, 500, 600, large

#### Copper Nozzles (inches)

**NS-5818C** 5/8 ID, 1/8 rec., small

**N-5818C** 5/8 ID, 1/8 rec., large

**N-5814C** 5/8 ID, 1/4 rec., large

**N-3414C** 3/4 ID, 1/4 rec., large

#### Contact Tips (inches)

**T-035** .035

**T-045** .045

**T-052** .052

**T-062** 1/16

#### Contact Tip Insulator

**7010024** For Dura-Flux gun with fixed power cable liner only

#### Contact Tip Holder

**7010026** For Dura-Flux gun with fixed power cable liner only

### Quik Tip™ Consumables

#### Diffusers (amps)

**D118Q** 300, 400

**D114Q** 500, 600

#### Plated Copper Nozzles (inches)

**N1C58Q** 5/8 ID

**N1C34Q** 3/4 ID

#### Contact Tips (inches)

**T1035** .035

**T1045** .045

**T1116** 1/16

#### Contact Tip Insulator

**7010062** For Dura-Flux gun with replaceable power cable liner only

### TOUGH LOCK® Consumables

#### Diffusers (amps)

**404-44-25** 300, 400, 500, 600 HD

#### Copper Nozzles (inches)

**401-6-62** 5/8 ID, 1/8 rec., HD

**401-5-75** 3/4 ID, 1/4 rec., HD

#### Contact Tips (inches)

**403-20-35-25** .035 HD

**403-20-45-25** .045 HD

**403-20-52-25** .052 HD

**403-20-116-25** 1/16 HD

Visit [Tregaskiss.com](http://Tregaskiss.com) or your distributor for additional Bernard consumable options.

# Spoolmate™ Spool Guns

Reliable and economical spool guns designed for home hobbyists and light fabricators.



Spoolmate 100

Spoolmate 100 includes carrying case that holds gun and cable, extra contact tips, nozzle and wire (wire sold separately).



Spoolmate 150

**PORTABLE!**



Spoolmate 200



Spoolmate 3035

## Spoolmate 100 See literature M/1.45

**Light industrial gun** for 4043 series aluminum wire rated at 135 amps at 30 percent duty cycle.

**12-foot direct-connect cable** with heavy-duty strain relief provides extended reach and accessibility to your work.

**Dual V-knurl drive rolls with adjustable tension control** for consistent feeding of different types of wire.

**Clear spool canister** protects the wire and allows easy view of spool.

**Includes carrying case, extra contact tips and nozzle.**

## Spoolmate 150 See literature M/1.46

**Light industrial gun** for 4000 or 5000 series aluminum wire rated at 150 amps at 60 percent duty cycle.

**20-foot direct-connect cable** with heavy-duty strain relief provides extended reach and accessibility to your work.

**Heavy-duty head tube.**

**Dual V-knurl drive rolls with adjustable tension control** for consistent feeding of different types of wire.

**Clear spool canister** protects the wire and allows easy view of spool.

## Spoolmate 200 See literature M/1.47

**Light industrial gun** for 4000 or 5000 series aluminum wire rated at 160 amps at 60 percent duty cycle.

**20-foot weld/control cables** with strain relief and sheath provide extended reach and accessibility to your work.

**Wire feed speed adjustment on the gun** – not machine – for easy setup.

**Easy access to drive assembly and drive rolls.**

**Two-stage trigger with built-in gas valve** allows for gas preflow/postflow.

**Toolless head tube removal** allows easy replacement. Comes standard with heavy-duty head tube. Three optional head tubes available.

## Spoolmate 3035 See literature M/1.5

**Light industrial gun** for 4000 or 5000 series aluminum wire rated at 150 amps at 60 percent duty cycle.

**20-foot weld/control cables** with strain relief and sheath provide extended reach and accessibility to your work.

**Light weight and well balanced** for operator comfort.

**Clear spool canister** protects the wire and allows easy view of spool.

**Easy-to-remove head tube assembly.**

Light industrial ● **CV DC**

Use with CV, DC power sources.

### Processes

- MIG (GMAW) with aluminum and other soft alloy wires
- MIG (GMAW) with hard wires

### Suggested power sources

#### For Spoolmate 100

- Millermatic® 141/211 (pg 7)
- Multimatic® 200/215 (pg 37)
- Multimatic® 220 AC/DC (pg 38)
- Multimatic® 235 (pg 39)
- Syncrowave® 210 (pg 54) (requires MIG accessory kit 301254)

#### For Spoolmate 150

- Millermatic® 211 (pg 7)
- Multimatic® 200 (pg 37) (effective with serial number MF364047N)
- Multimatic® 215 (pg 37)
- Multimatic® 220 AC/DC (pg 38)
- Multimatic® 235 (pg 39)
- Syncrowave® 210 (pg 54) (requires MIG accessory kit 301254)

#### For Spoolmate 200

- Millermatic® 252 (pg 8)
- Millermatic® 255 (pg 9)
- Multimatic® 235 (pg 39)
- Multimatic® 255 (pg 40)
- Bobcat™ 200 Air Pak™ (pg 75)

#### For Spoolmate 3035

- Direct connect to vintage Millermatic 210/212 tapped-voltage models
- Millermatic® 141/211 (pg 7) (requires SGA 100 control 043856)
- Bobcat™ 225 (pg 76) (requires SGA 100C control 043857)

### Most popular accessories

#### For Spoolmate 200

- 45-Degree Head Tube 300591
- 9-Inch Extension Head Tube 300592
- 5-Inch Head Tube 243385
- Spoolmatic Adapter Cable 195287 Allows connection to older Millermatic 210 and 212 (non-Auto-Set)

#### For Spoolmatic 3035

- SGA 100 043856 (pg 126)
- SGA 100C 043857 (pg 126)
- Heavy-Duty Head Tube 195375

Visit [MillerWelds.com](http://MillerWelds.com) or your distributor for other Miller® options and accessories.

| Model/ Stock Number            | Welding Current Rating   | Wire Feed Speed  | Wire Type and Diameter Capacity  | Maximum Spool Size Capacity | Dimensions   | Net Weight with Cable Assembly             |
|--------------------------------|--|--|--|-----------------------------|--|--|
| <b>Spoolmate 100 (300371)</b>  | 135 A at 30% duty cycle  | 5-625 ipm (1.7-15.9 m/min.)<br>Wire speed dependent on power source used   | <b>Aluminum</b> .030-.035 in. (0.8-0.9 mm)<br><b>Solid steel</b> .023-.035 in. (0.6-0.9 mm)<br><b>Stainless</b> .023-.035 in. (0.6-0.9 mm) | 4 in. (102 mm)              | H: 11.5 in. (291 mm)<br>W: 3 in. (76 mm)<br>L: 13 in. (330 mm)   | 6 lb. (2.7 kg)<br>9 lb. (4.1 kg) with case |
| <b>Spoolmate 150 (301272)</b>  | 150 A at 60% duty cycle  | 115-715 ipm (2.9-18.1 m/min.)<br>Wire speed dependent on power source used | <b>Aluminum</b> .030-.035 in. (0.8-0.9 mm)<br><b>Solid steel</b> .030-.035 in. (0.8-0.9 mm)<br><b>Stainless</b> .030-.035 in. (0.8-0.9 mm) | 4 in. (102 mm)              | H: 11.5 in. (291 mm)<br>W: 3 in. (76 mm)<br>L: 12.5 in. (318 mm) | 7.3 lb. (3.2 kg)                           |
| <b>Spoolmate 200 (300497)</b>  | 160 A at 60% duty cycle,   | 70-875 ipm (1.8-22.2 m/min.)   | <b>Aluminum</b> .030-.035 in. (0.8-0.9 mm)<br><b>Solid steel</b> .023-.035 in. (0.6-0.9 mm)<br><b>Stainless</b> .023-.035 in. (0.6-0.9 mm) | 4 in. (102 mm)              | H: 9 in. (229 mm)<br>W: 2.5 in. (64 mm)<br>L: 14.5 in. (368 mm)  | 11 lb. (5 kg)                              |
| <b>Spoolmate 3035 (195016)</b> | 150 A at 60% duty cycle,<br>200 A at 60% duty cycle with optional heavy-duty head tube | 115-715 ipm (2.9-18.1 m/min.)  | <b>Aluminum</b> .030-.035 in. (0.8-0.9 mm)<br><b>Solid steel</b> .023-.035 in. (0.6-0.9 mm)<br><b>Stainless</b> .023-.035 in. (0.6-0.9 mm) | 4 in. (102 mm)              | H: 11.5 in. (291 mm)<br>W: 2.25 in. (57 mm)<br>L: 8 in. (203 mm) | 9.1 lb. (4.1 kg)                           |

# Spoolmatic® Spool Guns

Portable, aluminum wire feeder for industrial applications.



Spoolmatic

PORTABLE!



Spoolmatic Pro

## Spoolmatic See literature M/1.73

**Integrated spool canister** rotates 180 degrees for operator flexibility and comfort.

**Available in 15- or 30-foot cable lengths**, providing flexibility to be used in the shop and in the field.

**Two-stage trigger with built-in gas valve** allows for gas preflow and eliminates the need to purge long gas lines.

**Wire feed speed adjustment on the gun handle and reversible drive rolls** save time and money.

**Quick-change, single-turn contact tip** provides excellent performance and is easy to replace.

## Spoolmatic Pro (additional features) See literature M/1.76

**Wire tension settings.** 4000- or 5000-specific tension settings ensure the very best wire feeding performance and arc consistency.

**More durable motor and drive design** improves feedability and arc consistency while helping reduce downtime and maintenance costs.

**Easy access to drive assembly and removable toolless head tube** reduce service time by allowing a means of changing drive rolls and head tube, or performing routine maintenance, without disassembly of gun.

**Easy-to-rotate, self-seating head tube** allows for better access into tight spots, preventing leaks and providing excellent current transfer. Head tubes are common with the XR-Aluma-Pro™ and XR™-Pistol-Pro guns.

**Head tube options in several different lengths and bend configurations** are available for when a standard head tube doesn't fit the application.

Industrial ● CC CV DC

Use with CC/CV, DC power sources.

### Processes

- MIG (GMAW) with aluminum and other soft alloy wires
- MIG (GMAW) with hard wires
- Pulsed MIG (GMAW-P) with optional pulsing power source

### Suggested power source

#### For Spoolmatic (non-Pro model only)

- Millermatic® 252 (pg 8)
- Millermatic® 255 (pg 9)
- Millermatic® 350P/350P Aluminum (pg 10)
- Multimatic® 235 (pg 39)
- Multimatic® 255 (pg 40)

#### For both Spoolmatic models

- Bobcat™ 200 Air Pak™ (pg 75)
- Bobcat™ Series (pg 76) (requires WC-115A w/contactor 137546011)

These power sources require WC-24 control (137549)

- AlumaPower™ MPa (pg 11)
- Invision™ MPa (pg 14)
- XMT® Series (pg 42-45)
- Dimension™ 650/650 ArcReach® (pg 46)
- Trailblazer® Series (pg 78, 81)

### Most popular accessories

- WC-115A 137546 (pg 126)
- WC-115A with contactor 137546011 (pg 126)
- WC-24 137549 (pg 126)

Visit [MillerWelds.com](http://MillerWelds.com) or your distributor for other Miller® options and accessories.

\*Spoolmatic Pro requires gun wire kit (230708) to run 1/16 in. (1.6 mm) wire.

| Model/Stock Number  | Welding Current Rating   | Wire Feed Speed   | Wire Type and Diameter Capacity  | Maximum Spool Size Capacity | Dimensions  | Gun Only Net Weight |
|---|--------------------------|---|--|-----------------------------|---|---------------------|
| <b>Spoolmatic</b><br>(195156) 15 ft. (4.6 m) cable<br>(130831) 30 ft. (9 m) cable     | 200 A at 100% duty cycle | 70-875 ipm (1.8-22.2 m/min.)<br>Wire speed dependent on control or Millermatic used | <b>Aluminum*</b><br>.030-1/16 in. (0.8-1.6 mm)<br><b>Hard wire</b><br>.030-.045 in. (0.8-1.1 mm) | 4 in. (102 mm)              | H: 10.25 in. (260 mm)<br>W: 2.5 in. (64 mm)<br>L: 15.125 in. (384 mm) | 2.9 lb.<br>(1.3 kg) |
| <b>Spoolmatic Pro</b><br>(301147) 15 ft. (4.6 m) cable<br>(301148) 30 ft. (9 m) cable | 200 A at 100% duty cycle | 70-900 ipm (1.8-23 m/min.)<br>Wire speed dependent on control or Millermatic used   |  |                             | H: 10.75 in. (273 mm)<br>W: 2.5 in. (64 mm)<br>L: 15.375 in. (390 mm) | 3.0 lb.<br>(1.4 kg) |

Miller recommends



Filler metals are a critical component in any weld project. They become part of your end product and choosing the right filler metal can affect the look and quality of your weld.

To make your filler metal choice easier, **Hobart offers a FREE app for download** on both Android™ and Apple® devices. Features of the app include:

- Recommendations for aluminum, carbon steel and stainless steel welding
- Calculates the amount of filler metal needed for your job
- Heat input calculator
- Hardfacing cross-reference function

Download the Filler Metal Selector and Calculator app today.

# XR™ Push-Pull Guns

XR-Aluma-Pro and XR-Pistol guns work in conjunction with an XR-AlumaFeed SuitCase or select Millermatic machines to provide the best solution for push-pull applications.



XR-Aluma-Pro Lite

XR-Aluma-Pro

**PORTABLE!**



XR-Pistol

XR-Pistol-Pro

**Threaded quick-change 360-degree rotatable head tubes are available in different bends and lengths** for even those hard-to-reach welds. Over 30 different styles to fit your application and welder's preference.

**Wire tension settings (except XR-Pistol).** 4000- or 5000-specific tension settings ensure the very best wire feeding performance and arc consistency.

**Heavy-duty construction.** All internal components are designed to provide long lasting performance and feeding precision.

## XR-Aluma-Pro™ Lite See literature M/1.75

**Lightest weight gooseneck-style gun features rear trigger that allows access to hard-to-reach welds.**

## XR-Aluma-Pro™ See literature M/1.71

**Robust professional-grade gun has the highest duty cycle rating in its class.**

**Easy access to drive assembly and removable toolless head tube** reduce service time by allowing a means of changing drive rolls and head tube, or performing routine maintenance, without disassembly of gun.

## XR™-Pistol See literature M/1.73

**Reliable, cost-effective gun for light- to medium-industrial applications.**

## XR™-Pistol-Pro See literature M/1.74

**Exceptional aluminum welding results for heavy-industrial applications.**

**Most durable motor and drive design** improves feedability and arc consistency while helping reduce downtime and maintenance costs.

**Easy access to drive assembly and removable toolless head tube** reduce service time by allowing a means of changing drive rolls and head tube, or performing routine maintenance, without disassembly of gun.

**Industrial** ● XR-Aluma-Pro Lite  
**Heavy industrial** ● XR-Aluma-Pro and all Pistol models

 Use with CC/CV, DC power sources.

**Processes**

- MIG (GMAW) with aluminum wire (capable of other wires with optional hardware kits)
- Pulsed MIG (GMAW-P) with optional pulsing power source

**Suggested feeders/controls**

- XR-AlumaFeed® SuitCase® (pg 11)

**Suggested power sources**

- Millermatic® 252 (pg 8)
- Millermatic® 255 (pg 9) (XR-Aluma-Pro and XR-Pistol-Pro guns only)
- Millermatic® 350P/ 350P Aluminum (pg 10)
- Multimatic® 255 (pg 40) (XR-Aluma-Pro and XR-Pistol-Pro guns only)

*These power sources require an XR-AlumaFeed SuitCase*

- AlumaPower™ MPa (pg 11)
- Deltaweld® 350/500 (pg 12) (14-pin receptacle models only)
- Invision™ MPa (pg 14)
- XMT® Series (pg 42-45)
- Trailblazer® Series (pg 78, 81)

**Most popular accessories**

- Hardwire Liner Kit 198377

*Visit MillerWelds.com or your distributor for other Miller® options and accessories.*

\*Dependent on control box or Millermatic used. \*\*XR-Aluma-Pro and XR-Pistol-Pro require gun wire kit (230708) to run 1/16 in. (1.6 mm) wire.

| Model                          | Cable Length   |                |              |                 | Welding Current Rating   | Wire Feed Speed*             | Wire Type and Diameter Capacity       | Dimensions  | Gun Only Net Weight |
|--------------------------------|----------------|----------------|--------------|-----------------|--------------------------|------------------------------|---------------------------------------|---|---------------------|
|                                | 15 ft. (4.6 m) | 25 ft. (7.6 m) | 30 ft. (9 m) | 35 ft. (10.6 m) |                          |                              |                                       |   |                     |
| XR-Aluma-Pro Lite (Air-cooled) | –              | (300948)       | –            | –               | 175 A at 60% duty cycle  | 70-900 ipm (1.8-23 m/min.)   | Aluminum .030-.047 in. (0.8-1.2 mm)   | H: 4 in. (102 mm)<br>W: 1.9 in. (48 mm)<br>L: 15 in. (381 mm)           | 2.0 lb. (0.9 kg)    |
| XR-Aluma-Pro (Air-cooled)      | (301568)       | (301569)       | –            | (301570)        | 300 A at 100% duty cycle | 70-900 ipm (1.8-23 m/min.)   | Aluminum** .030-1/16 in. (0.8-1.6 mm) | H: 5 in. (127 mm)<br>W: 2.5 in. (64 mm)<br>L: 17 in. (432 mm)           | 2.5 lb. (1.1 kg)    |
| XR-Aluma-Pro (Water-cooled)    | (301571)       | (301572)       | –            | (301573)        | 400 A at 100% duty cycle |                              |                                       |   | 2.9 lb. (1.3 kg)    |
| XR-Pistol (Air-cooled)         | (198127)       | –              | (198128)     | –               | 200 A at 100% duty cycle | 70-875 ipm (1.8-22.2 m/min.) | Aluminum .030-1/16 in. (0.8-1.6 mm)   | H: 7.375 in. (187 mm)<br>W: 1.875 in. (48 mm)<br>L: 10.625 in. (270 mm) | 2.2 lb. (1 kg)      |
| XR-Pistol (Water-cooled)       | (198129)       | –              | (198130)     | –               | 400 A at 100% duty cycle |                              |                                       |   | 2.4 lb. (1.1 kg)    |
| XR-Pistol-Pro (Air-cooled)     | (300782)       | (300783)       | –            | (300784)        | 200 A at 100% duty cycle | 70-900 ipm (1.8-23 m/min.)   | Aluminum** .030-1/16 in. (0.8-1.6 mm) |   | 2.2 lb. (1 kg)      |
| XR-Pistol-Pro (Water-cooled)   | (300786)       | (300787)       | –            | (300788)        | 400 A at 100% duty cycle |                              |                                       |   | 2.4 lb. (1.1 kg)    |



To order automation solutions: Contact local Miller district manager or email [MWASales@MillerWelds.com](mailto:MWASales@MillerWelds.com)

For automation service/parts: Call **1-630-653-6819** or email [MWAService@MillerWelds.com](mailto:MWAService@MillerWelds.com)

## PERFORMARC™ ROBOTIC WELDING SYSTEM



**A family of pre-engineered automation cells to increase productivity and improve weld quality.**

**Fast installation.** Pre-wired and pre-assembled make setup fast and easy. Most systems are up and running in under two hours from delivery (connect power/wire/gas/floor mounting/install tooling).

**Integrated controls.** Control station and full-color teach pendant keep the operator informed, maximizing production uptime.

**Flexibility.** Fully welded frame allows easy relocation and reconnection as production plans or layouts change.

**Increased productivity.** Operator can load and inspect parts while robot is welding.

### A/B 180° Indexing Table Single-station load/unload system



**PA250M** 250 lb./side, 60 in. manually indexed table  
**PA350S** 350 lb./side, 66 in. servo indexing table  
**PA1500SW** 1,500 lb./side, 92 or 108 in. servo indexing table

### Side-by-Side Two-station load/unload system

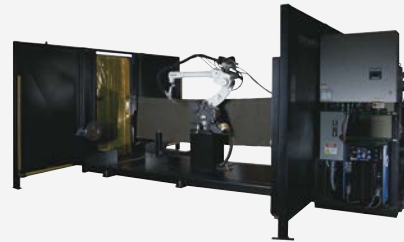

**Robot between dual head and tailstock/ single- or dual-robot configuration.**

**PA1100SS** 1,100 lb./side, 120 in. long x 44 in. turning diameter  
**PA2200SS** 2,200 lb./side, 120 in. long x 66 in. turning diameter

### A/B 180° Indexing H-Frame Single-station load/unload system



**Dual head and tailstock/ single- or dual-robot configuration.**

**PA550H** 550 lb./side, 48 in. long x 34 in. turning diameter on 92 in. servo indexer  
**PA550HW** 550 lb./side, 60 in. long x 40 in. turning diameter on 108 in. servo indexer  
**PA1100HW** 1,100 lb./side, 60 in. long x 40 in. turning diameter on 108 in. servo indexer

### A/B 180° Indexing Ferris Wheel Single-station load/unload system



**Dual head and tailstock/ single-, dual- or triple-robot configuration.**

**PA1100FW** 1,100 lb./side, 118 in. long x 43 in. turning diameter

## Laser Welding/Cladding System



**PL1100HW** 1,100 lb./side, 60 in. long x 34 in. turning diameter on 108 in. servo indexer

**Integrated laser solution with fiber cable management.**

- Autogenous, hotwire, coldwire or hybrid processes
- Class 1 laser-safe enclosure
- Available with fiber or diode laser configurations

To order automation solutions: Contact local Miller district manager or email [MWASales@MillerWelds.com](mailto:MWASales@MillerWelds.com)

For automation service/parts: Call 1-630-653-6819 or email [MWAService@MillerWelds.com](mailto:MWAService@MillerWelds.com)

## Active Wire Process (AWP)

Active wire is an advanced short arc welding process combining the robot motion path, welder waveform and servo wire feed control simultaneously reversing the wire at the short circuit to control the weld deposition precisely.

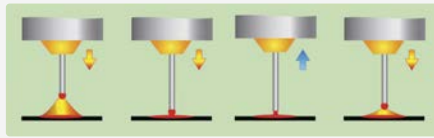

**Spatter control.** Spatter is virtually eliminated in all phases of the weld using mixed argon 90/10 or 100 percent CO<sub>2</sub> gas.

**Fast and clean arc striking.** At the moment the wire touches the base the wire is reversed, reducing arc strike spatter by up to 90 percent.

**Flexibility.** Large variations in torch angle are possible, allowing push-pull in and out of corners without increasing spatter.

**Appearance.** The precise nature of the process allows many customers an alternative to TIG welding.

**Wide range of materials.** Mild steels, stainless steels and aluminum from thin to medium gauge benefit from AWP.



## Thick Plate Welding

Fast and easy programming even on the most complex multi-pass weldments. All required commands and sensor setup in a single menu screen. Welding procedures can be developed quickly and transported easily from part to part.

**Graphical, menu-driven interface.** Pop-up graphical windows allow for fast programming of any welding joint in a single location.

**Multi-layer path control.** Easy-to-use interface to sequence the location of starts/stops and create multi-layer weld paths with appropriate offsets.

**Advanced sensors.** High-voltage touch sensing with menu-driven touch macros, a specialized high-amperage arc sensor system, and adaptive fill capability allow the weld process to adapt to incoming/varying production parts.



## DeskTop Programming and Simulation (DTPS)

**Software allows the development of programs offline,** minimizing robot downtime and maximizing throughput and productivity.

**Specialized software** generates programs and simulates the actual taught paths from your desktop.

**Native language programming.** Same language and functions that the technician will see on the teaching pendant, making program generation off-line easier than competitive code-based systems.

**Simplified file transfer.** Transfer robot programs between robot types, sizes and controller generations.

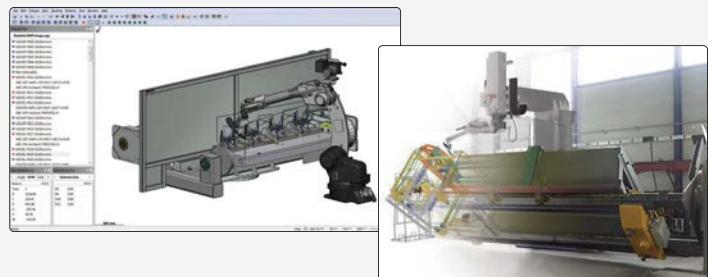

## Automation Components



Auto-Continuum™ power sources (pg 16)



Insight Core™, Centerpoint™ and ArcAgent™ Welding Intelligence™ (pg 69-71)



Tregaskiss® robotic MIG guns and reamers (pg 34-35)



FILTAIR® weld fume extraction system with low profile hood (pg 106-107)



Miller recommends Hobart® filler metals (visit [HobartBrothers.com](http://HobartBrothers.com))

## Jetline® Fixed Automation

Jetline offers a partnership to ensure you find the right solution to improve your weld quality and productivity – from design to installation, our engineers will help you get the results you need to stay competitive. Learn more at [MillerWelds.com/jetline](http://MillerWelds.com/jetline)



### Longitudinal Seam Welding Systems



Jetline longitudinal seam welders deliver speed and precision. Features include linear welding, high-volume cylinder production, joining thin-gauge or coiled sheets and more.

- High-precision travel and positioning result in weld accuracy
- Complete solution, single source
- Bolt-on control modules provide adaptability
- Aluminum hold-down fingers with copper tips absorb and dissipate heat
- Toe-touch tapeswitch control activates finger clamping
- Range includes:
  - External: flat sheets, cylinders and more
  - Internal: flat sheets and internal welds on cylinders
  - Combination: internal and external welds
  - Elevating: seam welder raises and lowers to accommodate diameters up to 96-inch OD
  - Bench: small seam welder for welding shorter, smaller parts

### Circumferential Welding Systems

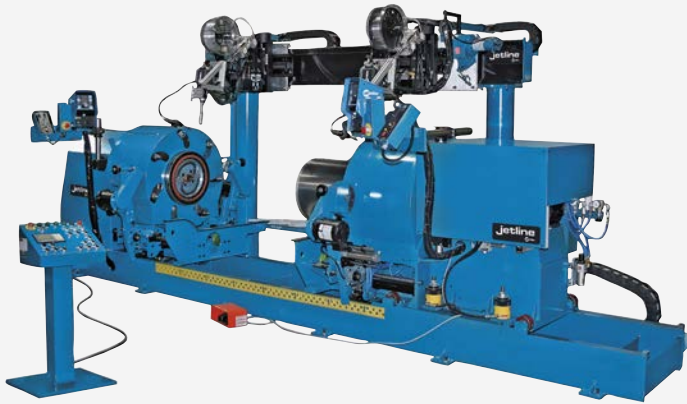

Jetline precision lathes and light-, medium- and heavy-duty circumferential welders handle a wide variety of part sizes and dimensions – from less than one pound up to 10,000 pounds, and from one inch up to 60 inches in diameter. Whatever the challenge, Jetline can work with you to find the perfect solution.

- Powered variable speed headstock
- Adjustable tailstock can be moved along the bed to accommodate differing part lengths
- Air-operated tailstocks apply a constant clamping pressure to the part throughout the welding cycle
- Range includes:
  - Precision: 500-pound maximum part
  - Light duty: 500-pound maximum part
  - Medium duty: 2,000-pound maximum part
  - Heavy duty: 10,000-pound maximum part

### Weld Head Locators



Jetline precision weld head locators provide a universal solution to position weld heads for circumferential and linear welding applications. With a variety of control systems, bolt-on accessories and base options, we can design the solution to meet your GTAW, GMAW and PAW needs.

- Jetline manipulators allow for simplified torch positioning
- Linear rails provide high-precision movement of the boom for linear welding
- 360 degrees of column rotation allows the weld head to be positioned over multiple fixtures
- Remote pushbutton pendant for weld head locator operation
- Range includes:
  - 6 x 6 foot
  - 9 x 9 foot
  - 12 x 12 foot

To order Jetline automation solutions: Contact local Miller district manager or email [JetlineSales@MillerWelds.com](mailto:JetlineSales@MillerWelds.com)

For Jetline service: Call 1-630-653-6819 or email [JetlineService@MillerWelds.com](mailto:JetlineService@MillerWelds.com)

## 9900 Controller



The 9900 controller is a touch screen industrial computer with an intuitive graphical user interface.

- Large 15-inch touch screen panel with industrial PC
- User-friendly graphical interface and easy programming using industry-standard terms
- Graphical representation of the weld parameters during the weld and programming
- Standard configuration controls up to 15 channels
- Ethernet and fiber optic communication for flexibility and speed
- Software options

## 9700 Controller



The 9700 controller is the standard Jetline control and sequencer used on our motor-driven equipment.

- Microprocessor-based control technology
- User-friendly front panel layout with large-screen graphic backlit display
- Closed-loop control for higher accuracy and stability
- Modbus® provides enhanced control of compatible Dynasty® and Maxstar® power sources for a single point of programming
- Processes include GTAW, GMAW, SAW and PAW
- Integrates with other optional Jetline components including arc length control, cold wire and hot wire feeders, and oscillators

## Arc Length Control



Jetline arc length control maintains a constant arc length by controlling arc voltage in gas tungsten arc welding (GTAW) or plasma arc welding (PAW) applications.

- Regulation of welding voltage for precise, repeatable welds
- Provides consistent performance and results
- Touch retract allows starting gap to be automatically preset in TIG (GTAW) applications
- Simplified setup and operation requires minimal operator intervention
- Standard package includes 9790 arc length control and 6-inch arc length control actuator

## Cold Wire Feed



Jetline cold wire feeder is used for automated gas tungsten arc welding (GTAW) or plasma arc welding (PAW) applications to add “fill” to a weld joint.

- Cold wire feeder system includes 9700W microprocessor control, four-roll feed assembly and wire guide positioner
- 9700W microprocessor controller offers a simple menu for setup and operation
- Four-roll feed assembly optimizes feeding of both hard and soft wires
- Wire guide positioner provides fine adjustment to position where the wire enters the weld puddle
- Optional clear spool cover protects the wire from the dust and dirt from the manufacturing environment

# Tregaskiss® Robotic Guns

Available with all PerformArc® robotic welding systems, fully configurable Tregaskiss TOUGH GUN® TA3 and CA3 robotic MIG guns are engineered for accurate, reliable and repeatable performance that maximizes production uptime and throughput. Upgrading to AccuLock™ R consumables has no impact on Tool Center Point (TCP).



TOUGH GUN  
TA3 MIG gun

TOUGH GUN  
CA3 MIG gun

## Air-Cooled MIG Guns

See Tregaskiss literature SP-TA3 and SP-CA3

### TA3 robotic MIG gun (internal to the robot arm)

- Available in 350-amp models at 100 percent duty cycle (mixed gases)
- Available as a complete package from the power pin to the contact tip
- Durable neck clamp provides consistent clamping force for repeatability and TCP accuracy
- Available with AccuLock™ R or TOUGH LOCK® consumables

### CA3 robotic MIG gun (external to the robot arm)

- Available in 385-amp models at 100 percent duty cycle (mixed gases)
- Replaceable unicable reduces downtime through faster repair and extended service life
- Cable guide minimizes stress on cable connection as robot articulates
- Durable neck clamp provides consistent clamping force for repeatability and TCP accuracy
- Available with AccuLock™ R or TOUGH LOCK® consumables

# Tregaskiss® Fixed Automatic Guns

Tregaskiss fixed automatic MIG guns are engineered for hard tooling automation applications requiring a simple, durable and repeatable MIG gun. These automatic torches can be configured with the same AccuLock family of consumables as your Bernard® semi-automatic or Tregaskiss robotic MIG guns to simplify your inventory.



MA1 MIG gun

MW1 MIG gun

AW2 MIG gun

## Air-Cooled MIG Guns

See Tregaskiss literature M033

### MA1 automatic MIG gun

- Available in 350-amp and 385-amp models
- Spring-guard strain relief prevents kinking and abrasion
- Air-cooled neck is made from aircraft-grade aluminum

## Water-Cooled MIG Guns

See Tregaskiss literature M033 and SP-WCA

### MW1 automatic MIG gun

- Available in 500-amp (MW15) and 600-amp (MW16) models
- Spring-guard strain relief prevents kinking and abrasion
- Stainless steel water-cooled neck is silver brazed and leak tested
- 600-amp water-cooled model has a thread-on heavy-duty nozzle

### AW2 automatic MIG gun

- Available in both cable and cableless 600-amp models
- Power cable equipped guns are available in lengths of 3 feet to 25 feet in 1/2-foot increments
- Internal threaded connections stay tight inside the anti-vibration compression fit body for good electrical connectivity and longer life
- Not compatible with QUICK LOAD® liners

## Industrial ●

**Process** ▪ MIG (GMAW)

**Compatible robots for robotic air-cooled guns**

- Panasonic® ▪ ABB® ▪ COMAU® ▪ FANUC®
- KUKA® ▪ Motoman® ▪ OTC Daihen®

**Packages**

- PerformArc Systems (pg 30)

**Most popular accessories**

- TOUGH GUN I.C.E.™ Technology – adds water-cooling to air-cooled guns for a boost in duty cycle
- Neck Checking Fixture
- TOUGH GUN TT3 Reamers (pg 35)

## Most popular consumables

### AccuLock™ R Consumables

**TA3, CA3 and MA1 Diffusers**

**D-ATSH** Slip-On

**D-ATTH** Thread-On

**MW1 Diffusers**

**D-ATSH** Slip-On (500 amps)

**D-ATTH-MW1** Thread-On (600 amps)

**AW2 Diffuser**

**D-ATSH-AW2** Slip-On

**TA3, CA3 and MA1 Nozzles (inches)**

**Slip-On**

**401-6-62** 5/8 ID, 1/8 recessed

**401-30-62** 5/8 ID, 1/8 stickout

**401-87-62** 5/8 ID, 1/8 stickout, tapered

**Thread-On**

**401-14-62** 5/8 ID, 1/8 recessed

**401-20-62** 5/8 ID, 1/8 stickout, tapered

**401-30-62T** 5/8 ID, 1/8 stickout

**MW1 Nozzles (inches)**

**Slip-On (500 amps)**

**401-6-62** 5/8 ID, 1/8 recessed

**401-5-62** 5/8 ID, 1/4 recessed

**Thread-On (600 amps)**

**601-6-62** 5/8 ID, 1/8 recessed

**601-5-75** 3/4 ID, 1/4 recessed

**AW2 Slip-On Nozzle**

**5627** 3/4 ID, 1/8 recessed

**Contact Tips (inches)**

**T-A039CH** .039 copper

**T-A045CH** .045 copper

**T-A039WH** .039 HDP

**T-A045WH** .045 HDP

**T-A052WH** .052 HDP

### 6 ft. QUICK LOAD® Liners

**TA3, CA3, MA1 and MW16 Liners (inches)**

**415-35-6Q** .035-.045

**415-116-6Q** .045-1/16

**TA3 and CA3 Liners (inches)**

**415-35-062Q** .035-.045, galvanized

**415-116-062Q** .045-1/16, galvanized

See literature SP-QLL for complete offering.

Visit [Tregaskiss.com](http://Tregaskiss.com) or your distributor for additional Tregaskiss consumable options.



For more information or to configure your gun online, visit

[Tregaskiss.com/ConfigureMyGun](http://Tregaskiss.com/ConfigureMyGun)



# Tregaskiss® TOUGH GUN® TT3 Reamers

See Tregaskiss literature SP-TT3

**TOUGH GUN TT3 reamer robotic nozzle cleaning stations provide automated spatter removal to help extend the life of your robotic MIG guns and consumables, increasing both production uptime and throughput while benefiting your bottom line.**



TOUGH GUN TT3E reamer shown with TOUGH GUN CA3 MIG gun.

**Tough on spatter and designed to operate reliably in even the harshest welding environments.**

**Two models available**

- TOUGH GUN TT3A (analog) reamer
- TOUGH GUN TT3E (Ethernet) reamer

**TT3E Ethernet model** is designed for durability, serviceability and repeatability. Provides greater control optimization, remote monitoring capability and faster troubleshooting to facilitate increased productivity.

**One-year warranty** on both TOUGH GUN TT3 reamer models. *Extend your warranty from one year to two years with the addition of a factory-installed Lubricator, OR from one year to three years with the addition of a factory-installed Lubricator, plus exclusive use of Tregaskiss TOUGH GARD anti-spatter liquid.*

**Industrial** ●

**Most popular accessories**

- Reamer Lubricator
- Nozzle Detect
- TOUGH GUN Reamer Stand – custom height, quick installation, easy on the budget



- **TOUGH GARD® Anti-Spatter Liquid**
- **TOUGH GARD® Multi-Feed System**

Visit [Tregaskiss.com](http://Tregaskiss.com) or your distributor for other Tregaskiss options and accessories.



For more information or to configure your reamer online, visit

[Tregaskiss.com/ConfigureMyGun](http://Tregaskiss.com/ConfigureMyGun)



# Tregaskiss® Welding Consumables



Slip-on diffuser cutaway with AccuLock contact tip shown



**AccuLock™ R consumables**

See Tregaskiss literature SP-ALR

**AccuLock contact tips** deliver longer life and quick, accurate replacement while maintaining the proven electrical conductivity and locking benefits of tapered connections.

- The contact tip's long tail centers it in the diffuser prior to engagement of the coarse thread, making it virtually impossible to cross-thread
- A quick 360-degree twist is all it takes to replace the contact tip
- Upgrade from TOUGH LOCK® consumables to the AccuLock contact tip and AccuLock R diffuser with no effect on Tool Center Point (TCP) in robotic applications
- Compatible with Tregaskiss nozzles and QUICK LOAD® liners
- Use AccuLock R consumables on Tregaskiss robotic and fixed automatic guns (see page 34) to simplify inventory and reduce replacement errors

**AccuLock HDP contact tips** provide even greater tip life for increased production throughput.

- Regain as much as 95 percent of lost productivity for contact tip changes
- HDP tips last 6 to 10 times longer than copper and chrome zirconium tips in pulse welding applications

**QUICK LOAD® liners**

See Tregaskiss literature SP-QLL

- Requires less than half the time and effort to replace compared to conventional liners
- Two-piece system with retainer installed inside the power pin on first use
- No need to cut and waste wire!
- Avoid climbing over robotic tooling or transfer systems to remove the torch from the wire feeder
- Change the liner from a safe zone in the robotic work cell
- Compatible with most Tregaskiss robotic and fixed automatic guns (see page 34)



# Multiprocess

For more detailed information, visit



MillerWelds.com/multiprocess



## Power Source Welding Performance

|                    |                       | Light Industrial          |                           |                                 | Industrial                |                           |                                     |  | Heavy Industrial              |                               |                          |
|--------------------|-----------------------|---------------------------|---------------------------|---------------------------------|---------------------------|---------------------------|-------------------------------------|--|-------------------------------|-------------------------------|--------------------------|
|                    |                       | Multimatic® 200 (page 37) | Multimatic® 215 (page 37) | Multimatic® 220 AC/DC (page 38) | Multimatic® 235 (page 39) | Multimatic® 255 (page 40) | Maxstar® 280 Multiprocess (page 41) | Dynasty® 280 DX Multiprocess (page 41) | XMT® 350 Models (pages 42-45) | XMT® 450 Models (pages 42-45) | Dimension™ 650 (page 46) |
| Material           | Mild Steel            | ●                         | ●                         | ●                               | ●                         | ●                         | ●                                   | ●                                      | ●                             | ●                             | ●                        |
|                    | Stainless Steel       | ●                         | ●                         | ●                               | ●                         | ●                         | ●                                   | ●                                      | ●                             | ●                             | ●                        |
|                    | Aluminum              | ●                         | ●                         | ●                               | ●                         | ●                         | ●                                   | ●                                      | ● <sup>1</sup>                | ● <sup>1</sup>                | ●                        |
| Material Thickness | Gauge (.020-.125 in.) | ●                         | ●                         | ●                               | ●                         | ●                         | ●                                   | ●                                      | ●                             | ●                             | ●                        |
|                    | Sheet (.125-.375 in.) | ●                         | ●                         | ●                               | ●                         | ●                         | ●                                   | ●                                      | ●                             | ●                             | ●                        |
|                    | Plate (.375-1 in.)    |                           |                           |                                 |                           |                           |                                     |  |                               | ●                             | ●                        |
|                    | Plate (1+ in.)        |                           |                           |                                 |                           |                           |                                     |  |                               | ●                             | ●                        |
| Wire Size          | .023 in.              | ●                         | ●                         | ●                               | ●                         | ●                         | ●                                   | ●                                      | ●                             | ●                             | ●                        |
|                    | .030 in.              | ●                         | ●                         | ●                               | ●                         | ●                         | ●                                   | ●                                      | ●                             | ●                             | ●                        |
|                    | .035 in.              | ●                         | ●                         | ●                               | ●                         | ●                         | ●                                   | ●                                      | ●                             | ●                             | ●                        |
|                    | .045 in.              | ●                         | ●                         | ●                               | ●                         | ●                         | ●                                   | ●                                      | ●                             | ●                             | ●                        |
|                    | .052 in.              |                           |                           |                                 |                           |                           | ●                                   | ●                                      | ●                             | ●                             | ●                        |
|                    | 1/16 in.              |                           |                           |                                 |                           |                           |                                     |  | ●                             | ●                             | ●                        |
|                    | 5/64 in.              |                           |                           |                                 |                           |                           |                                     |  | ●                             | ●                             | ●                        |
|                    | 3/32 in.              |                           |                           |                                 |                           |                           |                                     |  |                               | ●                             | ●                        |
| Process            | Short Circuit         | ★★★★                      | ★★★★                      | ★★★★                            | ★★★★                      | ★★★★                      | ★★★★                                | ★★★★                                   | ★★★★                          | ★★★★                          | ★★★★                     |
|                    | Pulsed Spray          |                           |                           |                                 |                           | ★★★★                      |                                     |  | ★★★★ <sup>2</sup>             | ★★★★ <sup>2</sup>             |                          |
|                    | Stick                 | ★★                        | ★★                        | ★★                              | ★★★                       | ★★★                       | ★★★★                                | ★★★★                                   | ★★★★                          | ★★★★                          | ★★★★                     |
|                    | AC TIG                |                           |                           | ★★★★                            |                           |                           |                                     | ★★★★                                   |                               |                               |                          |
|                    | DC TIG                | ★★★                       | ★★★★                      | ★★★★                            | ★★★                       | ★★★                       | ★★★★                                | ★★★★                                   | ★★★                           | ★★★                           | ★★★                      |
|                    | CAC-A                 |                           |                           |                                 |                           |                           | 3/16 in.                            | 3/16 in.                               | 1/4 in.                       | 5/16 in.                      | 3/8 in.                  |

### Icon Key

Capability: ● Designed for ● Capable of  
New! products appear in blue type.

Process Quality: ★ Good ★★ Better ★★★ Best ★★★★ Optimized

<sup>1</sup> CC/CV and FieldPro™ models are capable of aluminum welding. MPA models are designed for aluminum welding. XR-AlumaFeed® system is recommended for best results.

<sup>2</sup> MPA models only.

# Multimatic® 200 and 215

See literature DC/12.57 (200) and DC/12.59 (215)

Light industrial  



Multi-voltage plug (MVP™) allows connection to common 120- and 240-volt power receptacles without the use of any tools – simply choose the plug that fits the receptacle and connect to the power cord.



## Welding Capability

|                        |                       |
|------------------------|-----------------------|
| Max. 3/8 in. (9.5 mm)  | Max. 3/8 in. (9.5 mm) |
| MIG Mild Steel         | MIG Aluminum          |
| Min. 24 ga. (0.6 mm)   | Min. 18 ga. (1.2 mm)  |
| Max. 3/16 in. (4.8 mm) | Max. 3/8 in. (9.5 mm) |
| TIG Mild Steel         | Stick Mild Steel      |
| Min. 24 ga. (0.6 mm)   | Min. 16 ga. (1.5 mm)  |

Aluminum welding uses optional Spoolmate 100 and 4000 series aluminum wire **OR** Spoolmate 150 (effective with Multimatic 200 serial number MF364047N) and either 4000 or 5000 series aluminum wire. TIG welding uses optional TIG contractor kit.

**Weighing only 29 pounds (200) or 38 pounds (215)**, these lightweight MIG, stick and TIG welders provide portability on the job.

**Impact-resistant, flame-retardant case (200 only)** provides strength and durability, while protecting components and welding wire from moisture, dust and other contaminants.

**Auto-Set™ Elite** can be used on multiple materials and multiple processes with the ability to fine-tune your settings. Easy to set up and use!

**Excellent arc characteristics!** Positive arc starts and an extremely stable arc with minimal spatter.

**Auto Spool Gun Detect™** automatically detects when a MIG gun or spool gun is connected, eliminating the need for a switch.

**Uses 4- or 8-inch (102 or 203 mm) spools.**

## Multimatic 215 model additional features

**Intuitive color LCD interface** makes it quick and easy to adjust parameters.

**Angled cast-aluminum drive system** provides smooth feeding and the ability to use 10-, 12- or 15-foot guns.



## Processes

- MIG (GMAW) ▪ Flux-cored (FCAW)
- DC stick (SMAW) ▪ DC TIG (DC GTAW)

## Comes complete with

- 10 ft. (3 m) 250-amp MDX™-250 MIG gun with AccuLock™ MDX™ consumables (Multimatic 200) **OR** 10 ft. (3 m) 100-amp MDX™-100 MIG gun with AccuLock™ MDX™ consumables (Multimatic 215)
- 13 ft. (4 m) cable with electrode holder and 25 mm Dinse-style connector
- 10 ft. (3 m) work cable with clamp and 25 mm Dinse-style connector
- Power cord with MVP plugs for 120 V and 240 V
- Quick Select™ drive roll for .024 in. (0.6 mm) or .030/.035 in. (0.8/0.9 mm) solid wire, and .030/.035 in. (0.8/0.9 mm) flux-cored wire



- Flow gauge regulator and gas hose for argon or AR/CO<sub>2</sub> mix, extra MDX contact tips, information/settings chart and material thickness gauge (229895) – Hobart® spool of .030 in. solid wire and hook-and-loop cord wraps as seen in photo above are included with Multimatic 215 model only

## Most popular accessories

- Spoolmate™ Spool Guns (pg 27)
  - 300371 Spoolmate 100
  - 301272 Spoolmate 150
- Running Gear/Cylinder Rack 301239 (pg 118)
- Protective Cover 301262 (pg 121) (for Multimatic 215 only)
- TIG Contractor Kits (pg 124)
  - 301287 For Multimatic 200
  - 301337 For Multimatic 215

Visit [MillerWelds.com](http://MillerWelds.com) or your distributor for other Miller® options and accessories.

| Model/Stock Number  | Welding Mode/Process | Input Power                   | Amperage Range                  | Rated Output                    | Amps Input at Rated Output, 50/60 Hz |                               |      |     | Wire Feed Speed              | Max. Open-Circuit Voltage    | Dimensions   | Net Weight  |                  |
|---|----------------------|-------------------------------|---------------------------------|---------------------------------|--------------------------------------|-------------------------------|------|-----|------------------------------|------------------------------|--|---|------------------|
|   |                      |                               |                                 |                                 | 120 V                                | 230 V/240 V                   | KVA  | KW  |                              |                              |  |   |                  |
| <b>Multimatic 200</b> (907518) (951649) with TIG contractor kit (see page 124 for kit contents) | CV: MIG/flux-cored   | 120 V                         | 30-140                          | 90 A at 18.5 V, 60% duty cycle  | 18.0                                 | –                             | 2.2  | 2.0 | 70-425 ipm (1.8-10.8 m/min.) | 90 VDC                       | H: 14.5 in. (368 mm)<br>W: 9.75 in. (248 mm)<br>D: 17 in. (432 mm) | 29 lb. (13.2 kg)  |                  |
|   |                      |                               |                                 | 110 A at 19.5 V, 20% duty cycle | 22.4                                 | –                             | 2.7  | 2.6 |                              |                              |  |   |                  |
|   | 230 V                | 30-200                        | 150 A at 21.5 V, 20% duty cycle | –                               | 17.5                                 | 4.0                           | 3.8  |     |                              |                              |  |   |                  |
|   |                      |                               | CC: TIG                         | 120 V                           | 5-150                                | 150 A at 16 V, 30% duty cycle | 27.0 | –   | 3.3                          |                              |  |   | 3.2              |
|   | 230 V                | 5-150                         | 150 A at 16 V, 30% duty cycle   | –                               | 13.8                                 | 3.2                           | 3.0  |     |                              |                              |  |   |                  |
|   |                      |                               | CC: Stick                       | 120 V                           | 20-100                               | 100 A at 24 V, 35% duty cycle | 24.0 | –   | 2.9                          |                              |  |   | 2.8              |
| 230 V   | 20-150               | 150 A at 26 V, 30% duty cycle | –                               | 20.8                            | 4.8                                  | 4.5                           |      |     |                              |                              |  |   |                  |
|   |                      | CV: MIG/flux-cored            | 120 V                           | 30-125                          | 110 A at 19.5 V, 60% duty cycle      | 23.0                          | –    | 2.8 | 2.8                          | 60-600 ipm (1.5-15.2 m/min.) | 58 VDC   | H: 12.5 in. (318 mm)<br>W: 11.25 in. (286 mm)<br>D: 20.5 in. (521 mm) | 38 lb. (17.2 kg) |
| 240 V   | 30-230               |                               |                                 |                                 | 200 A at 24 V, 20% duty cycle        | –                             | 25.8 | 6.2 | 6.2                          |                              |  |   |                  |
|   |                      |                               |                                 |                                 | 150 A at 21.5 V, 40% duty cycle      | –                             | 16.7 | 4.0 | 4.0                          |                              |  |   |                  |
| CC: TIG   | 120 V                | 20-150                        | 140 A at 15.6 V, 40% duty cycle | 24.6                            | –                                    | 3.0                           | 3.0  | –   | 58 VDC                       |                              |  |   |                  |
|   |                      |                               | 240 V                           | 20-210                          | 190 A at 17.6 V, 20% duty cycle      | –                             | 18.0 |     |                              |                              |  | 6.7   | 6.7              |
| CC: Stick   | 120 V                | 30-100                        | 90 A at 23.6 V, 40% duty cycle  | 22.7                            | –                                    | 2.7                           | 2.7  | –   |                              |                              |  |   |                  |
|   |                      |                               | 240 V                           | 30-200                          | 190 A at 27.6 V, 20% duty cycle      | –                             | 27.0 |     |                              |                              |  | 6.5   | 6.5              |

# Multimatic® 220 AC/DC

See literature AD/9.0



Multi-voltage plug (MVP™) allows connection to common 120- and 240-volt power receptacles without the use of any tools – simply choose the plug that fits the receptacle and connect to the power cord.



See page 125

Light Industrial ● CC CV AC DC Phase 1

## Processes

- MIG (GMAW) = Flux-cored (FCAW)
- DC stick (SMAW) = AC/DC TIG (GTAW)
- Pulsed TIG (GTAW-P)

## Comes complete with

- 10 ft. (3 m) 100-amp MDX™-100 MIG gun with AccuLock™ MDX™ consumables
- 13 ft. (4 m) cable with electrode holder and 25 mm Dinse-style connector
- 12.5 ft. (3.8 m) Weldcraft™ A-150 (WP-17) TIG torch with 25 mm Dinse-style connector
- 10 ft. (3 m) work cable with clamp and 25 mm Dinse-style connector
- 6.5 ft. (2 m) power cord with MVP plugs for 120 V and 240 V
- RFCS-14 HD foot control with 20 ft. (6 m) cord
- Quick Select™ drive roll for .024 in. (0.6 mm) or .030/.035 in. (0.8/0.9 mm) solid wire, and .030/.035 in. (0.8/0.9 mm) flux-cored wire
- Two flow gauge regulators and gas hoses for argon or AR/CO<sub>2</sub> mix, extra contact tips, Hobart® spool of .030 in. solid wire, AK2C TIG torch accessory kit, hook-and-loop cord wraps and material thickness gauge (229895)

## Most popular accessories

- Spoolmate™ Spool Guns (pg 27)  
300371 Spoolmate 100  
301272 Spoolmate 150



- Dual Cylinder Rack Cart 951770 (pg 118)
- Protective Cover 301524 (pg 121)
- Wireless Remote Foot Control 300429 (pg 125)

Visit [MillerWelds.com](http://MillerWelds.com) or your distributor for other Miller® options and accessories.

## Welding Capability

|                       |                       |
|-----------------------|-----------------------|
| Max. 3/8 in. (9.5 mm) | Max. 3/8 in. (9.5 mm) |
| MIG Mild Steel        | MIG Aluminum          |
| Min. 24 ga. (0.6 mm)  | Min. 18 ga. (1.2 mm)  |
| Max. 1/4 in. (6.4 mm) | Max. 1/4 in. (6.4 mm) |
| TIG Mild Steel        | TIG Aluminum          |
| Min. 24 ga. (0.6 mm)  | Min. 24 ga. (0.6 mm)  |
| Max. 3/8 in. (9.5 mm) |                       |
| Stick Mild Steel      |                       |
| Min. 16 ga. (1.5 mm)  |                       |

MIG aluminum welding uses optional Spoolmate 100 and 4000 series aluminum wire OR Spoolmate 150 and either 4000 or 5000 series aluminum wire.

**All in one.** Comes equipped with all accessories to MIG, stick, AC and DC TIG weld with one machine – unlike other machines where you need to purchase additional accessories.

## Intuitive color LCD interface

makes it quick and easy to adjust parameters.



**Weighing only 56 pounds**, this lightweight MIG, stick and AC/DC TIG welder provides portability on the job.

**Innovative QuickTech™ technology** makes setup and changing processes easy.

- **Automatically** determines the polarity. Work is always connected to the bottom right receptacle. MIG gun and TIG torch can stay connected at the same time.
- **Automatically** switches to the right process. Just hit the trigger or the foot control and the machine automatically changes, eliminating the need to manually change processes.
- **Automatically** recalls the settings from the last process used.

**Auto-Set™ Elite** can be used on multiple materials and multiple processes with the ability to fine-tune your settings. Easy to set up and use!

**Pro-Set™ (TIG/stick)** eliminates the guesswork when setting weld parameters. Use Pro-Set when you want the speed, convenience and confidence of preset controls.

**Two shielding gas connections (one for MIG gas and one for TIG gas)** so both gases can be left connected to the machine – no switching needed.

**Manual mode offers additional TIG adjustments** for increased control including AC balance, AC frequency and DC pulsing.

**TIG high-frequency (HF) arc starting** for non-contact arc initiation, reducing tungsten and material contamination.

**Uses 4- or 8-inch (102 or 203 mm) spools.**

| Stock Number (907757) | Welding Mode/Process | Input Power | Amperage Range | Rated Output                    | Amps Input at Rated Output, 50/60 Hz |       |     |     | Wire Feed Speed              | Max. Open-Circuit Voltage | Dimensions  | Net Weight       |
|-----------------------|----------------------|-------------|----------------|---------------------------------|--------------------------------------|-------|-----|-----|------------------------------|---------------------------|---|------------------|
|                       |                      |             |                |                                 | 120 V                                | 240 V | KVA | KW  |                              |                           |   |                  |
| CV: MIG/flux-cored    |                      | 120 V       | 30-125         | 105 A at 19.2 V, 60% duty cycle | 23.3                                 | –     | 2.8 | 2.8 | 60-600 ipm (1.5-15.2 m/min.) | 45 VDC                    | H: 17.5 in. (445 mm)<br>W: 11.25 in. (286 mm)<br>D: 21.5 in. (546 mm) | 56 lb. (25.3 kg) |
|                       |                      |             |                | 200 A at 24 V, 20% duty cycle   | –                                    | 27.2  | 4.8 | 4.8 |                              |                           |   |                  |
|                       |                      |             |                | 170 A at 21.5 V, 40% duty cycle | –                                    | 21.5  | 3.8 | 3.8 |                              |                           |   |                  |
| CC: TIG               |                      | 120 V       | 20-140         | 130 A at 15.2 V, 40% duty cycle | 24.0                                 | –     | 2.9 | 2.9 | –                            | 46 VDC                    |   |                  |
|                       |                      |             |                | 210 A at 18.4 V, 20% duty cycle | –                                    | 22.4  | 5.4 | 5.4 |                              |                           |   |                  |
| CC: Stick             |                      | 120 V       | 30-90          | 90 A at 23.6 V, 40% duty cycle  | 24.5                                 | –     | 2.9 | 2.9 |                              |                           |   |                  |
|                       |                      |             |                | 200 A at 28.4 V, 15% duty cycle | –                                    | 31.3  | 7.5 | 7.5 |                              |                           |   |                  |

# Multimatic® 235

See literature DC/14.0



**NEW!**



See page 125

Multimatic 235 with running gear package shown.



**Easy-to-understand interface** with 4.3-inch color LCD display and intuitive connection setup images.

**Weighing only 63 pounds (machine only)**, this lightweight MIG, stick and DC TIG welder provides portability on the job.

**Compatible with Spoolmate™ 100, 150 and 200, and Spoolmatic 15A and 30A spool guns** to offer a variety of aluminum welding solutions.

**EXCLUSIVE! Auto-Gun Detect™** automatically adjusts voltage, wire speed and timers for faster switching between MIG and spool guns.

**Heavy-duty aluminum two-drive-roll system.**

**Uses 4-, 8- or 12-inch (102, 203 or 305 mm) spools.**

### Welding Capability

|                       |                         |
|-----------------------|-------------------------|
| Max. 3/8 in. (9.5 mm) | Max. 3/8 in. (9.5 mm)   |
| <b>Mild Steel</b>     | <b>Aluminum</b>         |
| Min. 24 ga. (0.6 mm)  | Min. 18 ga. (1.2 mm)    |
| Max. 3/8 in. (9.5 mm) | Max. 3/8 in. (9.5 mm)   |
| <b>TIG Mild Steel</b> | <b>Stick Mild Steel</b> |
| Min. 24 ga. (0.6 mm)  | Min. 16 ga. (1.5 mm)    |

Aluminum welding uses optional spool guns.  
TIG welding uses optional Multimatic 235/255 TIG kit.

**Auto-Set™ Elite** offers predefined weld settings to increase ease of use and ensure that the job is done right for operators of all skill levels.

- Available for MIG, stick and DC TIG processes with the ability to fine-tune your settings
- Set weld parameters by:
  - MIG – selecting wire and gas type, wire diameter and material thickness
  - Stick – selecting electrode type, electrode diameter and material thickness
  - DC Lift-Arc™ TIG – selecting remote on/off, tungsten diameter and material thickness

**Pro-Set™ (TIG/stick)** eliminates the guesswork when setting weld parameters. Use Pro-Set when you want the speed, convenience and confidence of preset controls.

**Two shielding gas connections (one for MIG gas and one for TIG gas)** so both gases can be left connected to the machine – no switching needed.

**Manual mode offers additional stick and TIG adjustments** for increased control including adjustable DIG control for stick and 0.1-150 pulses per second for DC pulsed TIG.

**Fan-On-Demand™** cooling system only operates when needed, reducing power consumption and keeping internal components cleaner.

Industrial ● CC CV DC 1 Phase

### Processes

- MIG (GMAW) ▪ Flux-cored (FCAW)
- DC stick (SMAW)
- DC Lift-Arc™ TIG (GTAW)
- Pulsed TIG (GTAW-P)

### Comes complete with

- 15 ft. (4.5 m) 250-amp MDX™-250 MIG gun with AccuLock™ MDX™ consumables
- 10 ft. (3 m) cable with electrode holder
- 10 ft. (3 m) work cable with clamp
- 7 ft. (2.1 m) industrial power cord
- Two factory-installed gas solenoids
- Flow gauge regulator and gas hose for argon or AR/CO<sub>2</sub> mix
- Chain to secure gas cylinder
- .030/.035 in. reversible V-groove drive rolls
- Extra contact tips and material thickness gauge (229895)

### Most popular accessories

- Spoolmate™ Spool Guns (pg 27)
    - 300371 Spoolmate 100
    - 301272 Spoolmate 150
    - 300497 Spoolmate 200
  - Spoolmatic® Spool Gun (pg 28) (non-Pro gun only)
  - EZ-Latch™ Single Cylinder Running Gear 301449 (pg 118)
  - EZ-Latch™ Dual Cylinder Rack with Elevated Gun and Cable Rack 301481
- Converts an EZ-Latch™ Single Cylinder Running Gear into a Dual Cylinder Rack Running Gear as seen below



- EZ-Latch™ Dual Cylinder Running Gear 951769 (pg 118)
- Protective Cover 301521 (pg 121)
- Multimatic 235/255 TIG Kit 301518 (pg 124)
- 10-Pin to 14-Pin Adapter Cord 301545 (pg 124)
- Wireless Remote Foot Control 300429 (pg 125)

Visit [MillerWelds.com](http://MillerWelds.com) or your distributor for other Miller® options and accessories.

\*Input voltage range for the Multimatic 235 is 204-276 V.

| Stock Number<br>(907780) 240 V<br>(951846) 240 V with single cylinder running gear<br>(951847) 240 V with dual cylinder running gear and TIG kit | Welding Mode/Process | Amperage Range | Rated Output                    | Amps Input at Rated Output, 50/60 Hz 240 V* |     |     | Wire Feed Speed              | Max. Open-Circuit Voltage | Power Source Dimensions   | Power Source Net Weight |
|--|----------------------|----------------|---------------------------------|---|-----|-----|------------------------------|---------------------------|---|-------------------------|
|  |                      |                |                                 | KVA   | KW  |     |                              |                           |   |                         |
|  | CV: MIG/flux-cored   | 30-235         | 170 A at 22.5 V, 60% duty cycle | 20.0  | 5.0 | 4.9 | 60-600 ipm (1.5-15.2 m/min.) | 54 VDC                    | H: 19.24 in. (489 mm)<br>W: 13.75 in. (349 mm)<br>D: 24.25 in. (616 mm) | 63 lb. (29 kg)          |
|  | CC: Stick            | 30-200         | 150 A at 26 V, 60% duty cycle   | 20.2  | 5.0 | 4.8 | –                            |                           |   |                         |
|  | CC: DC TIG           | 20-210         | 180 A at 17.2 V, 60% duty cycle | 17.0  | 4.2 | 4.1 |                              |                           |   |                         |

# Multimatic® 255

See literature DC/12.9



Multimatic 255 with running gear package shown.



See page 125

### Welding Capability

|                       |                        |
|-----------------------|------------------------|
| Max. 1/2 in. (13 mm)  | Max. 1/2 in. (13 mm)   |
| Mild Steel            | Aluminum               |
| Min. 22 ga. (0.8 mm)  | Min. 18 ga. (1.2 mm)   |
| Max. 3/8 in. (9.5 mm) | Max. 5/16 in. (7.9 mm) |
| TIG Mild Steel        | Stick Mild Steel       |
| Min. 24 ga. (0.6 mm)  | Min. 16 ga. (1.5 mm)   |

Aluminum welding uses optional XR-Aluma-Pro push-pull gun. TIG welding uses optional Multimatic 235/255 TIG kit.

**NEW! Pulsed MIG programs for silicon bronze and 98 argon/2 CO<sub>2</sub> stainless steel.**



**Easy-to-understand interface with 7-inch color LCD display** ensures proper machine setup and parameter selection, reducing setup time and increasing weld time.

- Quick-access process and weld mode backlit buttons across the top illuminate when active
- Soft-key buttons below the display change function depending on which screen is displayed – makes setup or change quick, easy and intuitive
- Large text for easier readability
- Intuitive connection setup images
- Full troubleshooting descriptions versus help errors and look up codes

**AUTO-LINE TECHNOLOGY** Allows for any input voltage hookup (208–575 V, single-phase) with no manual linking, providing convenience in any job setting. Ideal solution for dirty or unreliable power.

**Fan-On-Demand™** cooling system only operates when needed, reducing power consumption and keeping internal components cleaner.

**Built-in pulsed MIG programs.** All programmed information is restored after each power up – aluminum/steel/stainless steel.

**Auto-Set™ Elite** offers predefined weld settings to increase ease of use and ensure that the job is done right for operators of all skill levels.

- Available for MIG, pulsed MIG, stick and DC TIG processes with the ability to fine-tune your settings
- Set weld parameters by:
  - MIG – selecting wire and gas type, wire diameter and material thickness
  - Stick – selecting electrode type, electrode diameter and material thickness
  - DC Lift-Arc™ TIG – selecting remote on/off, tungsten diameter and material thickness

**Program mode** allows easy save and recall of favorite weld settings. Save up to four programs for each process. Delivers more productivity and consistent quality while minimizing supervisor intervention.

**EXCLUSIVE! Auto-Gun Detect™** automatically adjusts voltage, wire speed and timers for faster switching between MIG, push-pull and spool guns.

**Heavy-duty aluminum two-drive-roll system.**

**Uses 4-, 8- or 12-inch (102, 203 or 305 mm) spools.**

Industrial ● CC CV DC 1 Phase

### Processes

- MIG (GMAW) ▪ Flux-cored (FCAW)
- Pulsed MIG (GMAW-P)
- DC stick (SMAW)
- DC Lift-Arc™ TIG (GTAW)
- Pulsed TIG (GTAW-P)

### Comes complete with

- 15 ft. (4.5 m) 250-amp MDX™-250 MIG gun with Bernard® AccuLock™ S consumables
- 10 ft. (3 m) cable with electrode holder
- 10 ft. (3 m) work cable with clamp
- 10 ft. (3 m) industrial power cord
- Two factory-installed gas solenoids
- Flow gauge regulator and gas hose for argon or AR/CO<sub>2</sub> mix
- Chain to secure gas cylinder
- .035/.045 in. reversible V-groove drive rolls
- Extra contact tips and material thickness gauge (229895)

### Most popular accessories

- MDX™-250 EZ-Select™ MIG Gun 1770047 (pg 24)
  - Spoolmatic® Spool Gun (pg 28) (non-Pro gun only)
  - XR-Aluma-Pro™ Air-Cooled Push-Pull Guns (pg 29)
  - EZ-Latch™ Single Cylinder Running Gear 301449 (pg 118)
  - EZ-Latch™ Dual Cylinder Rack with Elevated Gun and Cable Rack 301481
- Converts an EZ-Latch™ Single Cylinder Running Gear into a Dual Cylinder Rack Running Gear as seen below



- **EZ-Latch™ Dual Cylinder Running Gear** 951769 (pg 118)
- Protective Cover 301521 (pg 121)
- Multimatic 235/255 TIG Kit 301518 (pg 124)
- 10-Pin to 14-Pin Adapter Cord 301545 (pg 124)
- Wireless Remote Foot Control 300429 (pg 125)

Visit [MillerWelds.com](http://MillerWelds.com) or your distributor for other Miller® options and accessories.

| Stock Number   | Welding Mode/Process | Amperage Range | Rated Output                    | Amps Input at Rated Output, 50/60 Hz | Wire Feed Speed            | Max. Open-Circuit Voltage | Power Source Dimensions   | Power Source Net Weight |
|--|----------------------|----------------|---------------------------------|--------------------------------------|----------------------------|---------------------------|---|-------------------------|
| (907728) 208–575 V<br>(951767) 208–575 V with single cylinder running gear<br>(951768) 208–575 V with dual cylinder running gear and TIG kit | CV: MIG/flux-cored   | 20–350         | 230 A at 25.5 V, 60% duty cycle | 208 V 240 V 460 V 575 V KVA KW       | 50–800 ipm (1.3–20 m/min.) | 81 VDC                    | H: 19.24 in. (489 mm)<br>W: 13.75 in. (349 mm)<br>D: 24.25 in. (616 mm) | 84 lb. (38 kg)          |
|  | CC: Stick            | 30–275         | 200 A at 28 V, 60% duty cycle   | 34.7 29.7 17.1 14.3 8.2 8.2          | –                          |                           |   |                         |
|  | CC: DC TIG           | 5–275          | 275 A at 21 V, 60% duty cycle   | 33.5 29 16.4 13.6 7.8 7.8            | –                          |                           |   |                         |

# Maxstar® 280 Multiprocess Dynasty® 280 DX Multiprocess

See literature DC/35.5 (Maxstar) and AD/4.95 (Dynasty)

**Multiprocess performance in a portable package. Designed for industrial applications that require a versatile solution with superior arc performance.**



Maxstar 280 Multiprocess (far left) and Dynasty 280 DX Multiprocess shown with ArcReach SuitCase 8 (packages available for Dynasty with ArcReach SuitCase, see below).



See page 125

**ArcReach® SuitCase® feeder** paired with the CV output of the Maxstar or Dynasty power source gives this unit MIG process capabilities.

Note: Maxstar and Dynasty are not capable of ArcReach control.

**AUTO-LINE TECHNOLOGY** Allows for any input voltage hook-up (208-575 V) with no manual linking, providing convenience in any job setting. Ideal solution for dirty or unreliable power.

**Blue Lightning™** high-frequency (HF) arc starter for non-contact arc initiation. Provides more consistent arc starts and greater reliability compared to traditional HF arc starters.

**Pulsed TIG** can be used to increase puddle agitation, arc stability and travel speeds while reducing heat input and distortion.

**Fan-On-Demand™** cooling system only operates when needed, reducing power consumption and keeping internal components cleaner.

**Cooler-On-Demand™** feature operates the auxiliary cooling system only when needed. Reduces noise, energy use, and airborne contaminants pulled through the cooler.



Dynasty 280 DX Multiprocess Complete package shown.

Industrial ● 

**Processes**

- AC/DC TIG (GTAW) ▪ Pulsed TIG (GTAW-P)
- MIG (GMAW)<sup>2</sup> ▪ Flux-cored (FCAW)<sup>2</sup>
- Stick (SMAW) ▪ Air carbon arc (CAC-A)

<sup>1</sup> Dynasty model only.

<sup>2</sup> With ArcReach SuitCase wire feeder.

**Comes with**

- 8 ft. (2.4 m) power cord (no plug)
- Two 50 mm Dinse-style connectors
- Two Dinse/Tweco® adapters
- 8 ft. (2.4 m) weld cable with Tweco®-style connectors to power feeder
- Quick reference guide

**Contractor packages include above, plus**

- Contractor kit with A-200 TIG torch and RCCS-14 fingertip control (301550) **OR** RFCS-14 HD foot control (301549)
- ArcReach® SuitCase® 8 **OR** ArcReach® SuitCase® 12 with two .035/.045 in. V-groove drive rolls
- Bernard® BTB Gun 300 A with three .035 in. and two .045 in. Centerfire™ contact tips

**Complete package includes ArcReach SuitCase 12 and Bernard BTB gun from package above, plus**

- Coolmate™ 1.3
- Coolant (4 one-gallon bottles)
- Small Runner™ cart
- Wireless foot control
- Weldcraft™ W-280 water-cooled torch kit

**Most popular accessories**

- ArcReach® SuitCase® Feeders (pg 18)
- Small Runner™ Cart 301318 (pg 119)
- Coolmate™ 1.3 300972 (pg 119)
- Contractor Kits (pg 124) 301311 w/RCCS-14 finger control 301309 w/RFCS-14 HD foot control
- Weldcraft™ Water-Cooled Torch Kits (pg 124) 300185 W-250 (WP-20) 300990 W-280 (WP-280) 301268 W-375
- Remote Controls (pg 124-125)

Visit [MillerWelds.com](http://MillerWelds.com) or your distributor for other Miller® options and accessories.

\*Refer to owner's manual for complete ratings.  
\*\*Sense voltage for low OCV stick and Lift-Arc™ TIG.

|               | Model/Stock Number  | Welding Process | Input Power | Welding Amp Range        | Rated Output at 60% Duty Cycle | Amps Input at Rated Load Output, 50/60 Hz |       |       |       |       |     |     |                   | Max. Open-Circuit Voltage   | Power Source Dimensions | Power Source Net Weight |
|---------------|---|-----------------|-------------|--------------------------|--------------------------------|---|-------|-------|-------|-------|-----|-----|-------------------|---|-------------------------|-------------------------|
|               |   |                 |             |                          |                                | 208 V                                     | 230 V | 400 V | 460 V | 575 V | KVA | KW  |                   |   |                         |                         |
| DC Maxstar    | Maxstar 280 Multiprocess (907552001) Power source only  | TIG             | 3-phase     | 1-280                    | 250 A at 20 V                  | 21  | 19    | 11    | 9     | 7     | 7.6 | 7.3 | 60 VDC (11 VDC**) | H: 13.6 in. (346 mm)<br>W: 8.6 in. (219 mm)<br>D: 22.5 in. (569 mm) | 47 lb. (21.3 kg)        |                         |
|               |   |                 | 1-phase     | 1-280                    | 250 A at 20 V                  | 35  | 32    | 18    | 16    | 13    | 7.3 | 7.1 |                   |   |                         |                         |
|               |   | Stick           | 3-phase     | 5-280                    | 250 A at 30 V                  | *   | *     | 14    | 13    | 10    | 9.9 | 9.6 |                   |   |                         |                         |
|               |   |                 | 1-phase     | 5-280                    | 180 A at 27.2 V                | 32  | 29    | *     | *     | *     | 6.7 | 6.5 |                   |   |                         |                         |
|               |   | MIG/flux-cored  | 3-phase     | 5-280                    | 250 A at 26.5 V                | *   | *     | 13    | 11    | 9     | 9.2 | 8.9 |                   |   |                         |                         |
|               |   |                 | 1-phase     | 5-280                    | 200 A at 24 V                  | 31  | 29    | *     | *     | *     | 6.5 | 6.3 |                   |   |                         |                         |
| AC/DC Dynasty | Dynasty 280 DX Multiprocess (907514007) Power source only (951796) Contractor w/fingertip and SuitCase 8 (951798) Contractor w/fingertip and SuitCase 12 (951797) Contractor w/foot and SuitCase 8 (951799) Contractor w/foot and SuitCase 12 (951757) Complete w/wireless foot and SuitCase 12 | TIG             | 3-phase     | 2-280 (AC)<br>1-280 (DC) | 250 A at 20 V                  | 21  | 19    | 11    | 9     | 7     | 7.6 | 7.3 | 60 VDC (11 VDC**) | H: 13.6 in. (346 mm)<br>W: 8.6 in. (219 mm)<br>D: 22.5 in. (569 mm) | 55 lb. (25 kg)          |                         |
|               |   |                 | 1-phase     | 2-280 (AC)<br>1-280 (DC) | 250 A at 20 V                  | 35  | 32    | 18    | 16    | 13    | 7.3 | 7.1 |                   |   |                         |                         |
|               |   | Stick           | 3-phase     | 5-280                    | 250 A at 30 V                  | *   | *     | 14    | 13    | 10    | 9.9 | 9.6 |                   |   |                         |                         |
|               |   |                 | 1-phase     | 5-280                    | 180 A at 27.2 V                | 32  | 29    | *     | *     | *     | 6.7 | 6.5 |                   |   |                         |                         |
|               |   | MIG/flux-cored  | 3-phase     | 5-280                    | 250 A at 26.5 V                | *   | *     | 13    | 11    | 9     | 9.2 | 8.9 |                   |   |                         |                         |
|               |   |                 | 1-phase     | 5-280                    | 200 A at 24 V                  | 31  | 29    | *     | *     | *     | 6.5 | 6.3 |                   |   |                         |                         |

# XMT® Series

Portability and excellent multiprocess arc performance make the XMT family the most popular in the industry. With many models to choose from the XMT family has the right solution for your business.



## Input power choices

**AUTO-LINE TECHNOLOGY** XMT 350 models allow for any input voltage hookup (208–575 V, single- or three-phase) with no manual linking, providing convenience in any job setting. Ideal solution for dirty or unreliable input power.

**Standard hookup** on XMT 450 models. 230/460 V manual link or 575 V, three-phase only.

## Advanced features for the professional welder

**Adaptive Hot Start™** makes starting stick electrodes easy without creating an inclusion.

**Infinite arc control** available in the stick and wire modes for easier fine tuning of tough-to-weld materials and out-of-position applications.

**Lift-Arc™** provides arc starting that minimizes contamination of the electrode and without the use of high frequency.

**Insight Core™ Welding Intelligence™ system.** XMT 14-pin models are Insight Core capable to monitor weld voltage, amperage, and arc-time and percentage.

## Reliability

**Wind Tunnel Technology™** Internal air flow that protects components, greatly improving reliability.

**Fan-On-Demand™** cooling system only operates when needed, reducing power consumption and keeping internal components cleaner.

## Welder-friendly control panel

**Process selector switch** reduces the number of control setup combinations without reducing any features.

**Ultra-tough, polycarbonate-blended cover** protects front controls from damage.

**Large, dual digital meters** are easy to view and presettable to ease setting weld output.

## Output connector choices

**Dinse- or Tweco®-style weld receptacles** (350 models) provide high-quality weld cable connections.

*Note: Two Dinse connectors are supplied with Dinse machines. Tweco connectors must be ordered separately.*

**Weld studs** (450 models).

**14-pin receptacle** provides a quick, direct connection to Miller® wire feeders. Capable of remote voltage control.

## Choose the Right XMT

|  | 350 Amp  |                       | 450 Amp   |             |
|--|--|-----------------------|---|-------------|
|  | XMT 350 CC/CV  | XMT 350 MPa           | XMT 450 CC/CV   | XMT 450 MPa |
| <b>Input Power</b>   | 3- or 1-phase power  |                       | 3-phase   |             |
| <b>Primary Operating Range</b>                                       | Auto-Line (208–575 V)                                      |                       | Manual link (230/460 V) or 575 V                            |             |
| <b>Weld Output</b>   | 350 A at 34 VDC<br>(3-phase input power at 60% duty cycle) |                       | 450 A at 38 VDC<br>(3-phase input power at 100% duty cycle) |             |
| <b>Carbon Arc Gouging</b>  | Rated: 1/4 in. (6.4 mm)                                    |                       | Rated: 5/16 in. (7.9 mm)                                    |             |
| <b>Net Weight</b>  | 80 lb. (36.3 kg)   |                       | 122 lb. (55.3 kg)   |             |
| <b>Output Connector</b>  | Dinse-style  | Dinse- or Tweco-style | 1/2 in. stud  |             |
| <b>Pulsed MIG</b>  | –  | Yes                   | –   | Yes         |
| <b>14-pin Compliant</b>  | Yes  |                       | Yes   |             |
| <b>Insight Core Capable</b><br>(requires Insight Core 14-pin module) | Yes<br>(page 70)   |                       | Yes<br>(page 70)  |             |
| <b>ArcReach™</b>   | Factory option<br>(page 44)                                | –                     | Factory option<br>(page 45)                                 | –           |

## XMT® 350 CC/CV and 450 CC/CV

See literature DC/18.93 (350) and DC/18.94 (450)

**Flexibility and simplicity make this the most popular model. It has the core multiprocess capabilities along with the flexibility of a 14-pin for spool guns, feeders and remote controls.**



**Heavy industrial**  XMT 450  
Phase Phase is 3-phase only.

### Processes

- MIG (GMAW) ▪ Pulsed MIG (GMAW-P)\*
- Stick (SMAW) ▪ TIG (GTAW)
- Flux-cored (FCAW)
- Air carbon arc cutting and gouging (CAC-A) (carbons – 350: 1/4 in., 450: 5/16 in.)

\*XMT MPa models only.

### Most popular accessories

- XR-AlumaFeed® SuitCase® 301567 (pg 11)
- SuitCase® Feeders (pg 18)
- 20 and 70 Series Feeders (pg 20)
- Spoolmatic® WC-24 (pg 28/126)
- MIGRunner™ Cart 195445 (pg 119)
- Running Gear Cylinder Rack 300408 (pg 119)
- Coolmate™ Coolant System (pg 119)
- Industrial MIG 4/0 Kits (pg 121)
  - 300405 For XMT 350
  - 300390 For XMT 450
- Gas Valve Kit
  - See literature DC/18.93 (350) and DC/18.94 (450)

Visit [MillerWelds.com](http://MillerWelds.com) or your distributor for other Miller® options and accessories.

## XMT® 350 MPa and 450 MPa

See literature DC/18.93 (350) and DC/18.94 (450)

**Built-in pulse programs for manufacturing and fabrication applications that have benefits for standard steels, high-strength steels and aluminum.**

**Pulse programs** provide a reduced heat-affected zone and good gap filling ability, and are great for thick to thin metal. They allow welding in all positions, as well as faster travel speeds and deposition.

**SharpArc®** controls the arc in pulsed MIG mode and gives total control over the arc cone shape, puddle fluidity and bead profile.

### Additional features when using a 70 Series MPa Plus feeder or XR-AlumaFeed® SuitCase® feeder.

#### Synergic pulsed MIG.

As wire speed increases/decreases, pulse parameters also increase/decrease to match the right amount of power needed, reducing the need to make additional adjustments.

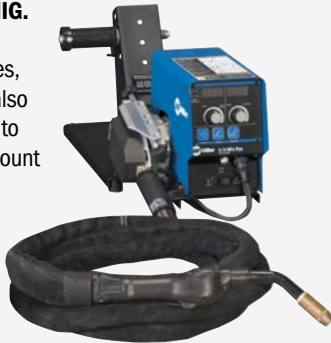

**Profile Pulse™** provides TIG appearance with MIG simplicity and productivity.



Achieve “stacked dimes” without gun manipulation. Profile Pulse frequency can be changed to increase or decrease the spacing between the ripple pattern to achieve the desired weld appearance.

**Added capabilities with Insight Core.™** When using an MPa Plus feeder, wire deposition is added to the Insight Core capabilities.

<sup>1</sup> Optional 115-volt auxiliary power provides 10 amps of circuit-breaker protected power for coolant systems, etc.

<sup>2</sup> Feeders include gun and drive rolls. MIGRunner adds 2/0 weld cable and 2/0 work cable with clamp, flowmeter regulator with gas hose and MIGRunner cart.

<sup>3</sup> Duty cycle rating below achieved with 6-gauge input power cord (8-gauge cord supplied with unit).

|       | Model/Stock Number<br>Most Popular Models ◀   | Input Power | Amperage/<br>Voltage<br>Ranges | Rated Output                                    | Amps Input at Rated Load Output, 60 Hz               | Max. Open-Circuit Voltage | Power Source Dimensions   | Power Source Net Weight |
|-------|---|-------------|--------------------------------|---|--|---------------------------|---|-------------------------|
|       |   |             |                                |   | 208 V 230 V 400 V 460 V 575 V KVA KW                 |                           |   |                         |
| 350 A | XMT 350 CC/CV (Dinse)<br>(907161) ◀ 208-575 V power source only<br>(907161011) 208-575 V w/auxiliary power <sup>1</sup><br>(951786) 208-575 V MIGRunner w/20 Series Basic <sup>2</sup><br>(951314) 208-575 V MIGRunner w/S-74D <sup>2</sup> | 3-phase     | 5-425 A<br>10-38 V             | 350 A at 34 VDC,<br>60% duty cycle              | 40.4 36.1 20.6 17.8 14.1 14.2 13.6                   | 75 VDC                    | H: 17 in. (432 mm)<br>W: 12.5 in. (318 mm)<br>D: 24 in. (610 mm)        | 80 lb.<br>(36.3 kg)     |
|       | XMT 350 MPa (Dinse except where noted)<br>(907366) ◀ 208-575 V power source only<br>(907366011) 208-575 V w/auxiliary power <sup>1</sup><br>(907366014) 208-575 V w/Twoce®  | 1-phase     | 5-425 A<br>10-38 V             | 300 A at 32 VDC,<br>60% duty cycle <sup>3</sup> | 60.8 54.6 29.7 24.5 19.9 11.7 11.2                   |                           |   |                         |
| 450 A | XMT 450 CC/CV (1/2 in. stud)<br>(907481) ◀ 230/460 V power source only<br>(907482) 575 V w/ArcReach   | 3-phase     | 15-600 A<br>10-38 V            | 450 A at 38 VDC,<br>100% duty cycle             | — 51 — 27.6 24.4 22 18.9                             | 90 VDC                    | H: 17.25 in. (438 mm)<br>W: 14.5 in. (368 mm)<br>D: 27.125 in. (689 mm) | 122 lb.<br>(55.3 kg)    |
|       | XMT 450 MPa (1/2 in. stud)<br>(907479) ◀ 230/460 V power source only<br>(907479001) 230/460 V w/auxiliary power <sup>1</sup><br>(907480) 575 V power source only  |             |                                |   | — 51 — 27.6 23.6 21.6 18.3<br>(KVA is 23.5 on 575 V) |                           |   |                         |

# XMT® 350 FieldPro™ Systems

See literature DC/18.96



Top row left to right: ArcReach SuitCase 12 feeder, XMT 350 FieldPro power source, XMT 350 FieldPro with Polarity Reversing power source, and ArcReach Smart Feeder. Bottom row left to right: ArcReach Stick/TIG Remote and ArcReach Stick/TIG Remote with Polarity Reversing. Feeders include gun and drive rolls (see page 18 for details).

## ArcReach®

Every year, outdated welding equipment wastes hundreds of productive work hours – and thousands of dollars in profit – by forcing operators to make numerous walks from the weld joint to the welder. Welding systems with ArcReach technology let operators adjust welding parameters right at the weld joint without a control cord using the wire feeder or remote – maximizing arc-on time, improving safety and impacting the bottom line. See pages 18/47 for ArcReach feeders and page 47 for the Stick/TIG Remotes.

**Don't walk. Weld!** Learn more at [MillerWelds.com/arcreach](http://MillerWelds.com/arcreach)

### More jobsite productivity and efficiency

**Cable Length Compensation (CLC™)** ensures that the voltage a weld operator sets is the voltage they get by automatically adjusting voltage based on weld cable length, even hundreds of feet away from the power source.

**Polarity reversing models of power source and remote** are ideal for pipe and module assembly where changing polarity happens frequently.

**AUTO-LINE TECHNOLOGY** For portability and reliability, Auto-Line allows for any input voltage hookup (208–575 V, single- or three-phase) with no manual linking, providing convenience in any job setting. Ideal solution for dirty or unreliable power.

**Auto-Bind™** automatically establishes exclusive communication between the power source and the wire feeder, using the existing weld cables upon system power up.

### Exceptional arc performance

**Common weld failures can be minimized** with stick stops that are specifically programmed to eliminate arc strikes outside of the heat-affected zone.

**Regulated Metal Deposition (RMD®) and pulsed MIG** are fully supported, enabling operators to use these advanced processes in the field for faster, more-efficient welds.

### Increased uptime

**Delivers the performance you need.** XMT 350 FieldPro welders and ArcReach feeders and remotes have been extensively proven in the field.

**Wind Tunnel Technology™:** Internal air flow that protects electrical components and PC boards from dirt, dust, debris... greatly improving reliability.

**Eliminate expenses related to maintaining or replacing easily damaged control cords** because the weld cables are used to communicate weld parameters between the wire feeder and power source.

### Improved jobsite safety

**ArcReach® technology decreases the chances of slip, trip or fall injuries** by allowing weld operators to make parameter changes at the wire feeder or remote instead of having to travel through multistory and cluttered jobsites back to the power source.

### Maximum fleet compatibility

**Maximize fleet compatibility** and get the benefits of ArcReach when you pair XMT 350 FieldPro welders and ArcReach feeders with other ArcReach compatible products.

### More operator control

**Adjust While Welding (AWW™)** allows weld operators to change weld parameters while the arc is on.

**Inadvertent parameter changes by other jobsite workers can be easily avoided** because connecting an ArcReach accessory from the power source automatically locks out the power source's panel controls.

**Return to a previous weld process faster** because the power source is restored to its previous settings once the ArcReach accessory is removed.

**Auto-Process Select™ decreases the chance of an incorrect weld process being used** because it automatically sets the power source to the correct weld process based on the polarity applied to the weld accessory.

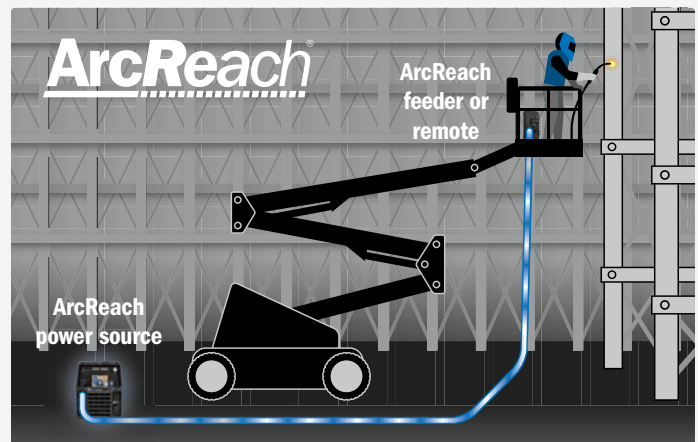

# XMT® 450 CC/CV ArcReach®

See literature DC/18.94



Note: XMT 450 CC/CV ArcReach does not support the Cable Length Compensation (CLC™) and Adjust While Welding (AWW™) features or the ArcReach Smart Feeder.

**Auto-Process Select.™** System automatically changes to MIG/FCAW (with gas) if electrode positive polarity is detected or FCAW (no gas) if electrode negative polarity is detected, when ArcReach communication is established between the feeder and the XMT – reducing the need to access the power supply.

**Automatic return to panel settings.** System automatically returns to XMT setting when ArcReach communication is terminated. For example, if the XMT is set to gouging at 550 amps and an ArcReach feeder is connected, the XMT will go to a MIG/FCAW process. If the feeder is disconnected, the XMT will go back to its previous setting (gouging at 550 amps).

**Auto-Bind™** automatically establishes exclusive communication between the power source and the wire feeder, using the existing weld cables upon system power up.

**Operator can precisely set arc voltage at the feeder** and monitor the actual arc voltage and current delivered to the weld using the digital meters on the feeder. This removes guesswork when it comes to adhering to weld procedures.

**Remote override of XMT.** When an ArcReach feeder is connected to an XMT 450 ArcReach the feeder has full control and the XMT controls are disabled, preventing accidental changes by personnel other than the welding operator.

**Heavy industrial**  XMT 450  
Phase Phase is 3-phase only.

**Processes**

- MIG (GMAW) ▪ Stick (SMAW)
- TIG (GTAW) ▪ Flux-cored (FCAW)
- RMD\* ▪ Pulsed MIG (GMAW-P)\*
- Air carbon arc cutting and gouging (CAC-A) (carbons – 304: 1/4 in., 350: 1/4 in., 450: 5/16 in.)

\*XMT 350 FieldPro only with ArcReach Smart Feeder.

**Stick/TIG system includes**

- XMT 350 FieldPro power source
- ArcReach Stick/TIG Remote

**MIG/flux-cored system includes**

- XMT 350 FieldPro power source
- ArcReach SuitCase 12 feeder with drive rolls and Bernard® BTB Gun 300 A

**RMD/pulse system includes**

- XMT 350 FieldPro power source
- ArcReach Smart Feeder with drive rolls and Bernard® PipeWox 300-15 MIG gun

**Most popular accessories**

- XR-AlumaFeed® SuitCase® 301567 (pg 11)
- ArcReach® SuitCase® Feeders (pg 18/47)
- ArcReach® Smart Feeder (pg 18/47) (for XMT 350 FieldPro power sources only)
- ArcReach® Heater (pg 47/92) (for XMT 350 FieldPro power sources only)
- 20 and 70 Series Feeders (pg 20)
- Spoolmatic®/WC-24 (pg 28/126)
- ArcReach® Stick/TIG Remote 301325 (pg 47)
- ArcReach® Stick/TIG Remote with Polarity Reversing 300934 (pg 47) (for XMT 350 FieldPro with Polarity Reversing power source only)



Visit [MillerWelds.com](http://MillerWelds.com) or your distributor for other Miller® options and accessories.

## XMT Racks

All the benefits of an individual XMT in an easy-to-transport package for multiple arcs in the field.



XMT 350 FieldPro Rack shown.

**Flexible solution.** The flexibility of the XMT makes it ideal for multiple system racks. Every system in a rack can be used for different tasks on-site, increasing fleet utilization and making the best use of equipment budgets.

**Easy installation.** The power distribution system on the rack allows the entire rack to be wired into a single power drop, isolating high-voltage power in the field.

| Model                                    | Stock Number         | Input Power to Rack                          |
|--|----------------------|--|
| XMT 350 FieldPro                         | 4-Pack Rack (907739) | 230-575 V, three-phase (fused for 460/575 V) |
|  | 6-Pack Rack (907740) |  |
| XMT 350 FieldPro with Polarity Reversing | 4-Pack Rack (907742) | 230-575 V, three-phase (fused for 460/575 V) |
|  | 6-Pack Rack (907741) |  |
| XMT 450 CC/CV ArcReach                   | 4-Pack Rack (907700) | 230/460 V, three-phase (fused for 460 V)     |

\*Optional 115-volt auxiliary power provides 10 amps of circuit-breaker protected power for coolant systems, etc.  
 \*\*Duty cycle rating below achieved with 6-gauge input power cord (8-gauge cord supplied with unit).

| Model/Stock Number<br>Most Popular Models | Input Power   | Amperage/Voltage Ranges | Rated Output        | Amps Input at Rated Load Output, 60 Hz |       |       |       |       |      |      | Max. Open-Circuit Voltage | Dimensions | Net Weight   |                      |
|---|---|-------------------------|---------------------|--|-------|-------|-------|-------|------|------|---------------------------|------------|--|----------------------|
|   |   |                         |                     | 208 V                                  | 230 V | 400 V | 460 V | 575 V | KVA  | KW   |                           |            |  |                      |
| 350 A                                     | XMT 350 FieldPro System (Tweco®)<br>(951736) Stick/TIG<br>(951734) MIG/flux-cored<br>(951738) RMD/pulse<br>XMT 350 FieldPro Power Source only<br>(907730) 208-575 V with Tweco®<br>(907730002) 208-575 V with Dinse   | 3-phase                 | 5-425 A<br>10-38 V  | 350 A at 34 VDC,<br>60% duty cycle     | 40.4  | 36.1  | 20.6  | 17.8  | 14.1 | 14.2 | 13.6                      | 75 VDC     | H: 17 in.<br>(432 mm)<br>W: 12.5 in.<br>(318 mm)<br>D: 24 in.<br>(610 mm)        | 93 lb.<br>(42.2 kg)  |
|   |   | 1-phase                 | 5-425 A<br>10-38 V  | 300 A at 32 VDC,<br>60% duty cycle**   | 60.8  | 54.6  | 29.7  | 24.5  | 19.9 | 11.7 | 11.2                      |            |  |                      |
|   | XMT 350 FieldPro with Polarity Reversing System (Tweco®)<br>(951737) Stick/TIG<br>(951735) MIG/flux-cored<br>(951739) RMD/pulse<br>XMT 350 FieldPro with Polarity Reversing Power Source only<br>(907731) 208-575 V with Tweco®<br>(907731001) 208-575 V with Dinse | 3-phase                 | 5-425 A<br>10-38 V  | 350 A at 34 VDC,<br>60% duty cycle     | 40.4  | 36.1  | 20.6  | 17.8  | 14.1 | 14.2 | 13.6                      | 75 VDC     | H: 17 in.<br>(432 mm)<br>W: 12.5 in.<br>(318 mm)<br>D: 24 in.<br>(610 mm)        | 93 lb.<br>(42.2 kg)  |
|   |   | 1-phase                 | 5-425 A<br>10-38 V  | 300 A at 32 VDC,<br>60% duty cycle**   | 60.8  | 54.6  | 29.7  | 24.5  | 19.9 | 11.7 | 11.2                      |            |  |                      |
| 450 A                                     | XMT 450 CC/CV ArcReach (1/2 in. stud)<br>(907481003) 230/460 V<br>(907481004) 230/460 V w/auxiliary power*<br>(907482) 575 V  | 3-phase                 | 15-600 A<br>10-38 V | 450 A at 38 VDC,<br>100% duty cycle    | –     | 51    | –     | 27.6  | 24.4 | 22   | 18.9                      | 90 VDC     | H: 17.25 in.<br>(438 mm)<br>W: 14.5 in.<br>(368 mm)<br>D: 27.125 in.<br>(689 mm) | 122 lb.<br>(55.3 kg) |

# Dimension™ 650 and 650 ArcReach®

See literature DC/19.3

**Developed for harsh environmental conditions and output requirements that range from power-intensive to precise.**



*Dimension 650 ArcReach power source shown with ArcReach SuitCase 12 feeder and ArcReach Stick/TIG Remote (all sold separately). Feeder includes Bernard BTB Gun 300 A OR S-Gun™ with reversible dual size (.045 and 1/16 in.) V-knurl drive rolls.*

## ArcReach®

Every year, outdated welding equipment wastes hundreds of productive work hours – and thousands of dollars in profit – by forcing operators to make numerous walks from the weld joint to the welder. Welding systems with ArcReach technology let operators adjust welding parameters right at the weld joint without a control cord using the wire feeder or remote – maximizing arc-on time, improving safety and impacting the bottom line. See pages 18/47 for ArcReach SuitCase feeders and page 47 for the Stick/TIG Remote. **Don't walk. Weld!** Learn more at [MillerWelds.com/arcreach](http://MillerWelds.com/arcreach)

*Note: Dimension 650 ArcReach does not support the Cable Length Compensation (CLC™) and Adjust While Welding (AWW™) features or the ArcReach Smart Feeder.*

**All aluminum construction** helps the machine resist corrosion for long life.

**Exclusive protection input inductor** protects machine's performance and reliability from "dirty" input power.

**Wind Tunnel Technology™** Internal air flow that protects components, greatly improving reliability.

**Fan-On-Demand™** cooling system only operates when needed, reducing power consumption and keeping internal components cleaner.

**High-quality performance** in all welding processes, from thick to thin metals.

**Arc control** available in the stick and wire modes for easier fine tuning of tough-to-weld materials and out-of-position applications.

**Reduced size and weight** results in an easier-to-handle package that exceeds the welding performance of larger, heavier machines. Dimension 650 is 3.5 times lighter than the Dimension 652 and also uses 40 percent less floor space.

**High electrical efficiency and excellent power factor** mean that you can get more welding done using less power. Dimension 650 uses up to 32 percent less amperage than the Dimension 652.

**Heavy industrial**   

### Processes

- MIG (GMAW) ▪ Flux-cored (FCAW)
- Stick (SMAW) ▪ TIG (GTAW)
- Submerged arc (SAW)
- Air carbon arc cutting and gouging (CAC-A) (rated 3/8 in. carbons)

### Dimension 650 Stationary package includes

- Power source
- S-74 MPa Plus feeder with Bernard® BTB Gun 400 A and .035/.045 in. drive rolls
- Industrial MIG 4/0 kit consisting of flowmeter regulator with 10 ft. (3 m) gas hose, 10 ft. (3 m) 4/0 feeder weld cable with lugs, and 15 ft. (4.6 m) work cable with 600-amp C-clamp

### Dimension 650 MIGRunner™ package includes above plus

- Running gear cylinder rack

### Most popular accessories



### ▪ Dimension 650 ArcReach® Rack 907701

- Comes assembled with four Dimension 650 ArcReach power sources fused for 460 volts
- ArcReach® SuitCase® Feeders (pg 18/47)
- 70 Series Feeders (pg 20)
- Bernard® MIG Guns (pg 25-26)
- ArcReach® Stick/TIG Remote 301325 (pg 47) (for ArcReach model only)
- Running Gear Cylinder Rack 300408 (pg 119)
- Industrial MIG 4/0 Kit (with lug connectors) 300390 (pg 121)
- Extension Cables (pg 126)
  - 242208025 25 ft. (7.6 m)
  - 242208050 50 ft. (15 m)
  - 242208080 80 ft. (24.4 m)

Visit [MillerWelds.com](http://MillerWelds.com) or your distributor for other Miller® options and accessories.

\*Dimension 650 with 575-volt input is 60 Hz only.

| Model/Stock Number  | Amperage/Voltage Ranges                                    | Rated Output                     | Amps Input at Rated Output, 50/60 Hz                | Max. Open-Circuit Voltage | Power Source Dimensions (Includes lift eye)                                | Power Source Net Weight |
|---|--|----------------------------------|---|---------------------------|--|-------------------------|
| <b>Dimension 650</b><br>(907617) 380/460 V power source only<br>(951638) 380/460 V stationary package<br>(951637) 380/460 V MIGRunner package | CC mode: 10-815 A<br>CV mode: 10-44 V<br>SAW mode: 10-65 V | 650 A at 44 VDC, 100% duty cycle | 380 V 460 V 575 V* KVA KW<br>53.2 42.8 34.3 34 30.7 | 87 VDC                    | H: 28.187 in. (716 mm)<br>W: 16.687 in. (424 mm)<br>D: 31.625 in. (803 mm) | 158 lb. (71.7 kg)       |
| <b>Dimension 650 ArcReach</b><br>(907617001) 380/460 V power source only<br>(907809) 575 V* power source only                                 |  |                                  |   |                           |  |                         |

# DONT WALK WELD™

## **ArcReach®** WELDING SYSTEMS

**The more they walk  
the more it costs.**



### ARCREACH PLUG-IN POWER SOURCES

#### **XMT® 350 FieldPro™ Systems** pg 44

Exceptional arc performance maximizes weld quality, minimizes defects.

#### **XMT® 350 FieldPro™ Systems with Polarity Reversing** pg 44

Provides outstanding stick and TIG performance for pipe welding, including automatic polarity selection.

#### **XMT® 450 CC/CV ArcReach®\*** pg 45

Portability and excellent arc performance with flexibility and simplicity.

#### **Dimension™ 650 ArcReach®\*\*** pg 46

For harsh environments and a wide range of output requirements.



### ARCREACH ENGINE-DRIVEN POWER SOURCES

#### **Trailblazer® 325 ArcReach® Models\*\*** pg 78

Unbeatable arc performance with superior runtimes and increased fuel efficiency.

#### **Big Blue® ArcReach® Models\*\*** pg 81–84

Tackle tough jobs that require high output for welding, gouging and aux power.



### ARCREACH WIRE FEEDERS

#### **ArcReach® SuitCase® Feeders** pg 18

For all ArcReach power sources. For MIG and flux-cored welding. Features remote voltage control and Auto-Process Select™.

#### **ArcReach® Smart Feeder** pg 18

For both XMT 350 FieldPro models and all ArcReach engine drives. For RMD® and pulsed MIG welding up to 200 feet from the power source.



### ARCREACH STICK/TIG REMOTES

#### **ArcReach® Stick/TIG Remote** 301325

For all ArcReach power sources except XMT 350 FieldPro with Polarity Reversing. Features remote amperage control, arc control for stick and Auto-Process Select.

#### **ArcReach® Stick/TIG Remote with Polarity Reversing** 300934

For XMT 350 FieldPro with Polarity Reversing power source only. Provides remote control functionality of the XMT 350 FieldPro with Polarity Reversing hundreds of feet from the power source, including process changeover and amperage adjustment — with no special cables.

## **ArcReach®** HEATING SYSTEMS

**Allows economical,  
insourced weld preheating.**



### ARCREACH HEATER AIR-COOLED INDUCTION SYSTEM

#### **ArcReach® Heater and Tools** pg 92

For all ArcReach power sources except XMT 450 CC/CV ArcReach and Dimension 650 ArcReach. Designed for preheating and bakeout applications up to 600 degrees Fahrenheit. Induction heating tools (air-cooled cables or air-cooled quick wraps) connect to the heater which is powered by an ArcReach power source.

\*Does not support the Cable Length Compensation (CLC) and Adjust While Welding (AWW) features or the ArcReach Smart Feeder.

\*\*Does not support the Cable Length Compensation (CLC) and Adjust While Welding (AWW) features.

# PipeWorx 400 Welding System

See literature PWS/2.0

Optimized for pipe fabrication shops.

PipeWorx 400 welding system shown with PipeWorx accessory kit for dual-wire feeder. Filler metal and shielding gas sold separately.



### Simple process setup

- The front panel was designed by welders for welders
- Requires just a few basic steps to set up a new weld process, resulting in less training time and minimizing errors from incorrect setups
- Memory feature stores four programs for each selection: stick, DC TIG, and MIG (left and right side of feeder) – eliminates the need to remember parameters

### True multiprocess machine

- Weld processes are optimized to deliver superior arc performance and stability, specifically for root, fill, and cap passes on pipe
- RMD® and pulsed MIG increase quality and productivity

### Quick process changeover

- Simply push a process selection button to choose a welding process
- Reduces setup time and the risk of weld reworks due to incorrect cable connections
- PipeWorx “Quick Select” technology automatically selects the welding process, the correct polarity, cable outputs, gas solenoid, and user-programmed welding parameters

### Single-system design

- One machine designed to perform all of your pipe welding needs
- Simplified and optimized specifically for pipe welding

Heavy industrial

### Processes

- Stick (SMAW) ▪ DC TIG (GTAW)
- MIG (GMAW) ▪ Flux-cored (FCAW)
- RMD ▪ Pulsed MIG (GMAW-P)
- Air carbon arc cutting and gouging (CAC-A)

### PipeWorx welding system comes complete with

- PipeWorx 400 power source with cable hangers (907382 **OR** 907384)
- Dual-wire feeder with drive rolls (300366)
- Two Bernard® PipeWorx 300-15 MIG guns (195400)
- Running gear with gas cylinder rack and handles (300368)
- Cable kit with 25 ft. (7.6 m) work sense lead (300367)

### Most popular accessories

- Bernard® PipeWorx Guns  
195399 15 ft. (4.6 m), 250-15  
195400 15 ft. (4.6 m), 300-15
- PipeWorx Accessories Kit for Dual-wire Feeder 300568  
Includes 25 ft. (7.6 m) work cable with EG500 clamp, two flowmeter regulators and two 5 ft. (1.5 m) gas hoses
- Composite Cable Kit  
300454 25 ft. (7.6 m)  
300456 50 ft. (15.2 m)
- PipeWorx Cooler 300370
- Foot Control Bracket 300676
- RFCS-14 HD 194744 (pg 124)
- RPBS-14 300666 (pg 124)

Visit [MillerWelds.com](http://MillerWelds.com) or your distributor for other Miller® options and accessories.

## Advanced Technologies of PipeWorx System

### Regulated Metal Deposition (RMD®)

- Higher quality root pass
- Calm stable arc
- Less spatter
- More tolerant of hi-lo conditions
- Reduced training requirements
- Less chance of cold lap or lack of fusion; reduces rework
- Can eliminate the need for a hot pass
- Can eliminate backing/purge gas in some stainless applications



RMD carbon steel

### Pulsed MIG

- Less heat input than traditional spray pulse transfer
- Shorter arc length
- Narrower arc cone
- Improved fusion and fill at the toes of the weld resulting in:
  - Faster travel speeds
  - Higher deposition rates
- Less training time required because pulsed MIG:
  - Virtually eliminates arc wander
  - Is easier to control the puddle
  - Compensates for tip-to-work variations automatically
- When used with RMD, it is possible to use one wire and one gas for all passes



Pulsed MIG stainless

\*Dimensions and weight are for power source only.

| Model/Stock Number<br>Most Popular System                              | Welding Mode/<br>Process | Amperage/<br>Voltage Ranges        | Rated Output at<br>100% Duty Cycle | Amps Input at Rated<br>Output, 60 Hz, 3-Phase |       |       | KVA                            |       |       | KW   |       |       | Max. Open-<br>Circuit<br>Voltage | Dimensions*  | Net<br>Weight*      |
|--|--------------------------|------------------------------------|------------------------------------|---|-------|-------|--------------------------------|-------|-------|--|-------|-------|----------------------------------|--|---------------------|
|  |                          |                                    |                                    | 230 V   | 460 V | 575 V | 230 V                          | 460 V | 575 V | 230 V  | 460 V | 575 V |                                  |  |                     |
| PipeWorx 400 Welding System<br>(951381) 230/460 V<br>(951382) 575 V    | CC: Stick                | 40-400 A                           | 400 A at 36 VDC                    | 43.9  | 26.6  | 22.4  | 17.5                           | 21.2  | 22.3  | 16.1   | 16.3  | 16.4  | 90 VDC                           | H: 28.5 in.<br>(724 mm)<br>W: 19.5 in.<br>(495 mm)<br>D: 31.75 in.<br>(806 mm) | 225 lb.<br>(102 kg) |
|  | CC/DC: TIG               | 10-350 A                           | 350 A at 24 VDC                    | 29.3  | 18.2  | 13.5  | 11.8                           | 14.5  | 13.4  | 10.7   | 10.6  | 10    |                                  |  |                     |
| PipeWorx 400 Power Source only<br>(907382) 230/460 V<br>(907384) 575 V | CV: MIG/flux-cored       | 10-44 V                            | 400 A at 34 VDC                    | 42.9  | 24    | 20.5  | 17.3                           | 19.2  | 20.5  | 16   | 15.8  | 16.2  |                                  |  |                     |
| Model/Stock Number   | Input<br>Power           | Input Welding<br>Circuit Rating    | Wire Feed Speed                    | Wire Diameter Capacity                        |       |       | Maximum Spool<br>Size Capacity |       |       | Dimensions   |       |       | Net Weight                       |  |                     |
| PipeWorx Dual-wire Feeder only<br>(300366)                             | 24 VAC,<br>11 A          | 100 V, 750 A at<br>100% duty cycle | 50-780 ipm<br>(1.3-19.8 m/min.)    | .035-.062 in. (0.9-1.6 mm)                    |       |       | 60 lb. (27 kg)                 |       |       | H: 14 in. (356 mm)<br>W: 19 in. (483 mm)<br>D: 29 in. (737 mm) |       |       | 90 lb. (41 kg)                   |  |                     |



For more detailed information, visit

MillerWelds.com/stick

GTAW | **Stick**



Also see Multiprocess and TIG sections for machines that can stick weld.

## Product Guide

|                         | Page | Class | Stick | DC TIG | Portability                             | Weldable Metals  | Welding Amperage Range | Special Features  | Typical Applications  |                      |
|-------------------------|------|-------|-------|--------|---|------------------|------------------------|---|---|----------------------|
| <b>Thunderbolt® 160</b> | 49   | ●     | ●     |        | Handle, shoulder strap                  | Steel, stainless | 20-160 DC              | Infinite amperage control, dual-voltage MVP™ plugs  | Garage/job shops, maintenance/repair, farm                    | <b>1-Phase</b>       |
| <b>Thunderbolt® 210</b> | 49   | ●     | ●     |        |   |                  | 25-210 DC              | Infinite amperage control   | Garage/job shops, maintenance/repair, farm                    |                      |
| <b>Maxstar® 161 S</b>   | 49   | ●     | ●     |        | Handle/shoulder strap, optional case    |                  | 20-160 DC              | Auto-Line™ (120-240 V), digital meter   | MRO, ship installation/repair, farm/ranch                     |                      |
| <b>Maxstar® 210 STR</b> | 50   | ●     | ●     | ●      | Handles, shoulder strap, optional carts | Steel, stainless | 5-210 DC               | Auto-Line™ (120-480 V), digital meters  | Construction, fabrication, pipe, steel erection, shipbuilding | <b>1- &amp; 3-Ph</b> |
| <b>CST™ 282</b>         | 51   | ●     | ●     | ●      | Handle, optional cart                   |                  | 5-280 DC               | Portable at 34.6 lb., Auto-Line™ (208-575 V), digital meter, also available in multioperator rack | Construction, fabrication, pipe, steel erection, shipbuilding |                      |
| <b>CST™ 282 Rack</b>    | 51   | ●     | ●     | ●      | Lift eye, casters                       | Steel, stainless | 5-280 DC               | Up to 4 or 8 operators, light weight  | Construction, maintenance/repair, shipbuilding                | <b>3-Ph</b>          |

### Product Key

Class: ● Light industrial ● Industrial ● Heavy industrial Capability: ● Designed for this process ● Capable of this process  
New! products appear in blue type.

# Thunderbolt® 160 and 210

See literature DC/37.0

Dependable, portable, powerful stick welder.



Thunderbolt 160 shown.

**Nearly 100 pounds lighter** so you can work smarter not harder by bringing the welder to the work.

**More powerful.** Up to 85 more amps compared to leading competitive machine means you can weld thicker materials.

**Hot Start™** technology provides easy, quick and reliable arc starts.



**Thunderbolt 160** includes multi-voltage plug (MVP™)

which allows for connection to 120- or 240-volt receptacles without tools. Choose the plug that fits the receptacle and connect it to the power cord.

Light industrial ● **CC DC 1** Phase

Process - Stick (SMAW)

**Comes complete with**

- 10 ft. (3 m) No. 4 electrode cable with heavy-duty electrode holder
- 10 ft. (3 m) work cable with clamp
- 6.5 ft. (2 m) power cord with MVP™ plugs for 120 V and 240 V (160 model) **OR** standard 240 V plug (210 model)
- Cable pouch

Visit MillerWelds.com or your distributor for Miller® options and accessories.

| Model/Stock Number              | Input Power | Welding Amperage Range | Rated Output            | Amps Input at Rated Output | Max. Open-Circuit Voltage | Dimensions             | Net Weight        |
|---------------------------------|-------------|------------------------|-------------------------|----------------------------|---------------------------|------------------------|-------------------|
| <b>Thunderbolt 160 (907721)</b> | 120 V       | 20-80                  | 65 A at 20% duty cycle  | 20.7                       | 91 VDC                    | H: 10.5 in. (267 mm)   | 15 lb. (6.8 kg)   |
|                                 | 240 V       | 20-160                 | 160 A at 30% duty cycle | 27.8                       | 91 VDC                    | W: 7.125 in. (181 mm)  |                   |
| <b>Thunderbolt 210 (907722)</b> | 240 V       | 25-210                 | 210 A at 20% duty cycle | 43.4                       | 85 VDC                    | D: 13.375 in. (340 mm) | 15.5 lb. (7.0 kg) |

# Maxstar® 161 S

See literature DC/27.3

Industrial class – provides maximum portability and performance in the most compact stick package in the industry.



Maxstar 161 S with X-CASE shown.



Allows for any input voltage hookup (120-240 V) with no manual linking, providing convenience in any job setting. Ideal solution for dirty or unreliable power.

**Portable with adjustable handle/shoulder strap.** Easy to transport at only 13 pounds.

**Fan-On-Demand™** power source cooling system operates only when needed, reducing noise, energy use and the amount of contaminants pulled through the machine.

**Digital meter** for more precise control when presetting or monitoring welding amperage.

**Adaptive Hot Start™** for stick arc starts.

**Stick-Stuck** detects if the electrode is stuck to the part and turns the welding output off to safely and easily remove the electrode. Menu selectable.

**Superior stick arc performance** even on the difficult-to-run electrodes like E6010.

Industrial ● **CC DC 1** Phase

Process - Stick (SMAW)

**Comes complete with**

- 6.5 ft. (2 m) power cords for 120 V and 240 V
- 13 ft. (4 m) electrode cable with holder and 25 mm Dinse-style connector
- 10 ft. (3 m) work cable with clamp and 25 mm Dinse-style connector
- Quick-reference guide

**907709001 includes above plus**

- Protective X-CASE™
- Most popular accessories
- Protective X-CASE™ 301429

Visit MillerWelds.com or your distributor for other Miller® options and accessories.

Note: See page 53 in the TIG section for Maxstar 161 STL and STH.  
\*Sense voltage for stick.

| Stock Number                            | Input Power | Welding Amperage Range | Rated Output                    | Amps Input at Rated Output, 50/60 Hz | KVA at Duty Cycle | KW  | Max. Open-Circuit Voltage | Dimensions           | Net Weight      |
|---|-------------|------------------------|---------------------------------|--------------------------------------|-------------------|-----|---------------------------|----------------------|-----------------|
| <b>(907709) (907709001) with X-CASE</b> | 120 V       | 20-90                  | 90 A at 23.6 V, 30% duty cycle  | 23.2                                 | 2.8               | 2.8 | 48 VDC (12-16 VDC*)       | H: 10.3 in. (262 mm) | 13 lb. (5.9 kg) |
|   | 240 V       | 20-160                 | 160 A at 26.4 V, 20% duty cycle | 22.6                                 | 5.4               | 5.3 |                           | W: 5.6 in. (142 mm)  |                 |
|   |             |                        |                                 |                                      |                   |     |                           | D: 13.5 in. (343 mm) |                 |

# Maxstar® 210 STR See literature DC/32.1

Maximum flexibility with automatic connection to any input power while maintaining the best DC stick/TIG welding performance in its product class.



**AUTO-LINE™ TECHNOLOGY** Allows for any input voltage hookup (120–480 V) with no manual linking, providing convenience in any job setting. Ideal solution for dirty or unreliable power.

**Lift-Arc™** provides TIG arc initiation without the use of high frequency.

**Dual schedule** allows operators to switch between welding parameters for specific electrodes without readjusting the machine.

**Hot Start™** adaptive control provides positive arc starts without sticking.

**Fan-On-Demand™** power source cooling system operates only when needed, reducing noise, energy use and the amount of contaminants pulled through the machine.

**Remote amperage control.**

**Digital meters** for more precise control when presetting or monitoring welding amperage.

**Portable with adjustable shoulder strap.**

Industrial ● **CC DC 3 1**  
Phase Phase

**Processes**

- Stick (SMAW) • TIG (GTAW)

**Comes complete with**

- 8 ft. (2.4 m) power cord (no plug)
- Two 50 mm Dinse-style connectors

**Most popular accessories**

- 12.5 ft. (3.8 m) Weldcraft™ A-150 Valve TIG torch WP-17V-25-2 (pg 61)
- Remote Controls (pg 124)
- Air-Cooled TIG Torch Connector (pg 125)

Visit [MillerWelds.com](http://MillerWelds.com) or your distributor for other Miller® options and accessories.

Note: See page 56 in the TIG section for Maxstar 210 Series.  
\*Sense voltage for stick and Lift-Arc TIG.

| Stock Number (907682) | Welding Process | Input Power | Welding Amperage Range         | Rated Output                    | Phase        | Amps Input at Rated Load Output, 50/60 Hz |       |       |       |       |     | Max. Open-Circuit Voltage (11 VDC*) | Dimensions<br>H: 13.6 in. (346 mm)<br>W: 8.6 in. (219 mm)<br>D: 19.5 in. (495 mm) | Net Weight (36 lb. (16.3 kg)) |
|-----------------------|-----------------|-------------|--------------------------------|---------------------------------|--------------|---|-------|-------|-------|-------|-----|-------------------------------------|---|-------------------------------|
|                       |                 |             |                                |                                 |              | 120 V                                     | 208 V | 240 V | 400 V | 480 V | KVA |                                     |   |                               |
|                       | Stick           | 208-480 V   | 5-210                          | 160 A at 26.4 V, 60% duty cycle | Three-phase  | –   | 15    | 13    | 8     | 6     | 5.5 | 5.2                                 |   |                               |
|                       |                 |             |                                |                                 | Single-phase | –   | 26    | 22    | 13    | 11    | 5.3 | 5.3                                 |   |                               |
|                       | 120 V           | 5-100       | 90 A at 23.6 V, 60% duty cycle | Single-phase                    | 23           | –   | –     | –     | –     | 2.8   | 2.8 |                                     |   |                               |
|                       | TIG             | 208-480 V   | 1-210                          | 210 A at 18.4 V, 60% duty cycle | Three-phase  | –   | 14    | 12    | 7     | 6     | 5.2 | 4.9                                 |   |                               |
| Single-phase          |                 |             |                                |                                 | –            | 24  | 20    | 12    | 10    | 4.9   | 4.9 |                                     |   |                               |
|                       |                 | 120 V       | 1-210                          | 125 A at 15 V, 60% duty cycle   | Single-phase | 22  | –     | –     | –     | –     | 2.6 | 2.6                                 |   |                               |

## REGISTER YOUR NEW EQUIPMENT

**COMPLETE REGISTRATION AS SOON AS POSSIBLE — IT'S QUICK AND EASY.**

Registering your new Miller® equipment may help with any future insurance claims or in the event we need to contact you regarding changes or upgrades. Whether you're a DIY welder or have purchased Miller® equipment on behalf of the company for which you work... **all Miller® equipment should be registered** so we can provide you with the highest level of service.

Register now at [MillerWelds.com/register](http://MillerWelds.com/register)



# CST™ 282

See literature DC/29.6

**Durable power source designed for the construction industry. Ideal for stick electrodes up to 3/16-inch and TIG welding of pipe and plate.**

**NEW!**



**WIRELESS  
REMOTE  
COMPATIBLE**  
See page 125

CST 282 with Tweco®-style receptacles shown.

**Superior stick arc performance** even on the difficult-to-run electrodes like E6010.

**AUTO-LINE TECHNOLOGY** For portability and reliability, Auto-Line allows for any input voltage hookup (208–575 V, single- or three-phase) with no manual linking, providing convenience in any job setting. Ideal solution for dirty or unreliable power.

**Digital meter** for more precise control when presetting or monitoring welding amperage.

**Portable** in the shop or at the jobsite – at 34.6 pounds (15.7 kg) the CST 282 is easily moved from location to location.

**Lift-Arc™** provides TIG arc initiation without the use of high frequency.

**Universal connector system** allows the machine to be quickly configured to either Tweco®- or Dinse-style receptacles. Extra receptacles and wrench are sold separately as Universal Connector Kits.



**Industrial** ● **CC DC 3 1**  
Phase Phase

**Processes**

- Stick (SMAW)
- TIG (GTAW)

**Comes with**

- 6 ft. (1.8 m) power cord

**Most popular accessories**

- CST 282 Rack (see below)
- Remote Controls (pg 124–125)
- Universal Connector Kits
  - 301611 Tweco-style receptacles
  - 301595 Dinse-style receptacles
- For TIG torches see literature DC/29.6

Visit [MillerWelds.com](http://MillerWelds.com) or your distributor for other Miller® options and accessories.

| Stock Number<br>(907770) Tweco®<br>(907810) Dinse<br>208–575 V | Welding Process | Input Power                    | Welding Amperage Range | Rated Output                    | Amps Input at Rated Load Output, 50/60 Hz |       |       |       |       | KVA | KW   | Max. Open-Circuit Voltage | Dimensions   | Net Weight            |         |  |  |
|--|-----------------|--------------------------------|------------------------|---------------------------------|---|-------|-------|-------|-------|-----|------|---------------------------|--|-----------------------|---------|--|--|
|  |                 |                                |                        |                                 | 208 V                                     | 230 V | 400 V | 460 V | 575 V |     |      |                           |  |                       |         |  |  |
|  | Stick           | Three-phase                    | 30–280                 | 280 A at 31.2 V, 35% duty cycle | 29.63                                     | 26.65 | 15.71 | 13.92 | 12.08 | 12  | 10.2 | 103 VDC                   | H: 13.5 in.<br>(343 mm)<br>W: 8 in.<br>(203 mm)<br>D: 18.5 in.<br>(470 mm) | 34.6 lb.<br>(15.7 kg) |         |  |  |
|  |                 |                                |                        | 200 A at 28 V, 100% duty cycle  | 18.86                                     | 17.09 | 10.6  | 9.37  | 8.02  | 8   | 6.4  |                           |  |                       |         |  |  |
|  |                 | Single-phase                   | 30–280                 | 200 A at 28 V, 50% duty cycle   | 33.7                                      | 30.65 | 17.61 | 16.18 | 14.51 | 8.3 | 6.6  |                           |  |                       |         |  |  |
|  |                 |                                |                        | 150 A at 26 V, 100% duty cycle  | 23.07                                     | 20.59 | 12.97 | 11.8  | 11.15 | 6.4 | 4.5  |                           |  |                       |         |  |  |
|  | TIG             | Three-phase                    | 5–280                  | 280 A at 21.2 V, 35% duty cycle | 20.77                                     | 18.85 | 11.54 | 10.22 | 8.95  | 8.9 | 7.1  |                           |  |                       | 9.5 VDC |  |  |
|  |                 |                                |                        | 200 A at 18 V, 100% duty cycle  | 12.89                                     | 11.74 | 7.42  | 6.55  | 5.49  | 5.4 | 4.3  |                           |  |                       |         |  |  |
| Single-phase   | 5–280           | 200 A at 18 V, 50% duty cycle  | 22.12                  | 19.71                           | 12.89                                     | 11.06 | 10.61 | 6.1   | 4.4   |     |      |                           |  |                       |         |  |  |
|  |                 | 150 A at 16 V, 100% duty cycle | 14.84                  | 13.38                           | 8.73                                      | 8.63  | 7.72  | 5.1   | 2.9   |     |      |                           |  |                       |         |  |  |

# CST™ 282 Racks

See literature DC/29.6

**Rugged enclosure provides simple means for protecting and transporting multiple welding power sources for construction, power plant turn-arounds and shipbuilding applications.**

**NEW!**



4-pack rack

8-pack rack

Note: For additional rack systems see XMT® Racks on page 45 and Dimension 650 ArcReach Rack on page 46.

**WIRELESS  
REMOTE  
COMPATIBLE**  
See page 125

**One easy connection** allows up to eight inverters to be connected with one primary power drop.

**All controls including power switch are located on front of machine** for easy access.

**Top cover** protects machines from falling debris.

**Lift eye(s)** simplify crane or overhead lifting device transport.

**Lift truck fork pockets.**

**Common output ground connection** (for same polarity use only).

**Racks include casters** that can be bolted to the rack base. Two swivel casters and two non-swivel casters. Large 5-inch diameter wheels enable the rack to be moved over grating and driveway gravel.

**Heavy industrial** ● **CC DC 3**  
Phase

**Processes**

- Stick (SMAW)
- TIG (GTAW)

**Comes with**

- Cables to connect power sources to common work connection
- 5-inch casters

**Most popular accessories**

- Remote Controls (pg 124–125)
- For TIG torches see literature DC/29.6

Visit [MillerWelds.com](http://MillerWelds.com) or your distributor for other Miller® options and accessories.

| Model              | Stock Number           | Rack Capacity   | Input Power to Rack                                | Amps Input at Rated Load Output, 50/60 Hz |       |       | KVA | KW                        | Dimensions (H x W x D) (Includes lift eye)     | Net Weight       |
|--------------------|------------------------|-----------------|--|---|-------|-------|-----|---------------------------|--|------------------|
|                    |                        |                 |  | 230 V                                     | 460 V | 575 V |     |                           |  |                  |
| <b>4-Pack Rack</b> | <b>(951883)</b> Tweco® | 4 units         | 208–575 V, three-phase, 50/60 Hz (fused for 460 V) | 106.5                                     | 56    | 48.5  | 48  | 40.8                      | 50.75 x 25.5 x 26.5 in. (1,289 x 648 x 673 mm) | 330 lb. (150 kg) |
| <b>8-Pack Rack</b> | <b>(907812)</b> Tweco® | 8 units         |  | 213                                       | 112   | 97    | 96  | 81.6                      |  |                  |
| <b>Empty Rack</b>  | <b>(301609)</b>        | 4 units         | –  | –   | –     | –     | –   | Same as 4-pack rack above | 166 lb. (75 kg)                                |                  |
|                    |                        | <b>(301610)</b> | 8 units  | –   | –     | –     | –   | –                         | Same as 8-pack rack above                      | 280 lb. (127 kg) |



**TIG | GTAW**

Also see Multiprocess section for machines that can TIG weld.

For more detailed information, visit



**MillerWelds.com/tig**



**Product Guide**

|                               | Page            | Class | TIG | Pulsed TIG | Stick | CAC-A | MIG/Flux-cored | Max. Electrode Diameter |          |          |          |          | Material Thickness Range (TIG)                 | Welding Amperage Range                       | Pulse Capability                                      | Net Weight   | Generator Power Requirement |        |
|-------------------------------|-----------------|-------|-----|------------|-------|-------|----------------|-------------------------|----------|----------|----------|----------|--|--|---|--|-----------------------------|--------|
|                               |                 |       |     |            |       |       |                | E6010/11                | E6013    | E7018    | E7024    | CAC-A    |  |  |   |  |                             |        |
| <b>DC (Steel)</b>             | Maxstar® 161    | 53    | ●   | ●          | ●     | ●     |                |                         | 5/32 in. | 1/8 in.  | 1/8 in.  | 3/32 in. | —  | .020-3/16 in.                                | 5-160 A   | 0-150 pps (STH model)                              | 13 lb. (5.9 kg)             | 5.3 kW |
|                               | Maxstar® 210    | 56    | ●   | ●          | ●     | ●     |                |                         | 3/16 in. | 3/16 in. | 5/32 in. | 5/32 in. | —  | .002-1/4 in.                                 | 1-210 A   | 0.1-250 pps (base model)<br>0.1-500 pps (DX model) | 38 lb. (17.2 kg)            | 9 kW   |
|                               | Maxstar® 280    | 56    | ●   | ●          | ●     | ●     | ●              |                         | 7/32 in. | 3/16 in. | 3/16 in. | 3/16 in. | 3/16 in.                                       | .004-3/8 in.                                 | 1-280 A   | 0.1-250 pps (base model)<br>0.1-500 pps (DX model) | 47 lb. (21.3 kg)            | 11 kW  |
|                               | Maxstar® 400    | 58    | ●   | ●          | ●     | ●     | ●              |                         | 5/16 in. | 5/16 in. | 1/4 in.  | 1/4 in.  | 1/4 in.  | .012-5/8 in.                                 | 3-400 A   | 0.1-5,000 pps                                      | 134 lb. (61 kg)             | 20 kW  |
|                               | Maxstar® 800    | 58    | ●   | ●          | ●     | ●     | ●              |                         | 5/16 in. | 5/16 in. | 5/16 in. | 5/16 in. | 3/8 in.  | .020-1 in.                                   | 5-800 A   | 0.1-5,000 pps                                      | 198 lb. (90 kg)             | 45 kW  |
| <b>AC/DC (Aluminum/Steel)</b> | Diversion™ 180  | 53    | ●   | ●          |       |       |                | —                       | —        | —        | —        | —        | .030-3/16 in. (alum.)<br>.025-3/16 in. (steel) | 10-180 A                                     | —   | 50 lb. (23 kg)                                     | 5.5 kW                      |        |
|                               | Syncrowave® 210 | 54    | ●   | ●          | ●     | ●     | ●              | 5/32 in.                | 1/8 in.  | 1/8 in.  | 3/32 in. | —        | .020-1/4 in. (aluminum/steel)                  | 5-210 A                                      | 0.1-150 pps   | 133.5 lb. (61 kg)                                  | 6 kW                        |        |
|                               | Syncrowave® 300 | 55    | ●   | ●          | ●     | ●     |                | 5/32 in.                | 5/32 in. | 1/8 in.  | 1/8 in.  | —        | .015-3/8 in. (alum.)<br>.012-1/2 in. (steel)   | 5-300 A                                      | 0.1-150 pps   | 101 lb. (45.8 kg)                                  | 9 kW                        |        |
|                               | Syncrowave® 400 | 55    | ●   | ●          | ●     | ●     |                | 3/16 in.                | 3/16 in. | 3/16 in. | 3/16 in. | —        | .015-3/8 in. (alum.)<br>.012-5/8 in. (steel)   | 5-400 A                                      | 0.1-150 pps   | 131 lb. (59.4 kg)                                  | 14 kW                       |        |
|                               | Dynasty® 210    | 56    | ●   | ●          | ●     | ●     |                | 3/16 in.                | 3/16 in. | 5/32 in. | 5/32 in. | —        | .012-1/4 in. (alum.)<br>.002-1/4 in. (steel)   | 2-210 A (AC)<br>1-210 A (DC)                 | 0.1-250 pps (base, DC only)<br>0.1-500 pps (DX model) | 47 lb. (21.3 kg)                                   | 9 kW                        |        |
|                               | Dynasty® 280    | 56    | ●   | ●          | ●     | ●     |                | 7/32 in.                | 3/16 in. | 3/16 in. | 3/16 in. | 3/16 in. | .012-3/8 in. (alum.)<br>.004-3/8 in. (steel)   | 2-280 A (AC)<br>1-280 A (DC)                 | 0.1-250 pps (base, DC only)<br>0.1-500 pps (DX model) | 52 lb. (23.6 kg)                                   | 12.5 kW                     |        |
|                               | Dynasty® 400    | 58    | ●   | ●          | ●     | ●     | ●              |                         | 5/16 in. | 5/16 in. | 1/4 in.  | 1/4 in.  | 1/4 in.  | .015-5/8 in. (alum.)<br>.012-5/8 in. (steel) | 3-400 A   | 0.1-500 pps (AC)<br>0.1-5,000 pps (DC)             | 134 lb. (61 kg)             | 20 kW  |
| Dynasty® 800                  | 58              | ●     | ●   | ●          | ●     | ●     |                | 5/16 in.                | 5/16 in. | 5/16 in. | 5/16 in. | 3/8 in.  | .020-1 in. (aluminum/steel)                    | 5-800 A                                      | 0.1-500 pps (AC)<br>0.1-5,000 pps (DC)                | 198 lb. (90 kg)                                    | 50 kW                       |        |

**Product Key**

Class: ● Light industrial ● Industrial ● Heavy industrial Capability: ● All models ● Some models  
New! products appear in blue type.

# Diversion™ 180 AC/DC TIG

See literature AD/1.5

Professional-grade arc in a package designed specifically for personal users. Contains all of the features you need – simplicity combined with superior performance and value.



### TIG Welding Capability

|                         |                          |
|-------------------------|--------------------------|
| Max. 3/16 in. (4.8 mm)  | Max. 3/16 in. (4.8 mm)   |
| <b>Steel</b>            | <b>Aluminum</b>          |
| Min. 0.025 in. (0.6 mm) | Min. 0.030 in. (0.75 mm) |



**Multi-voltage plug (MVP™)** allows for connection to 120- or 240-volt receptacles without tools. Choose the plug that fits the receptacle and connect it to the power cord.

**Fan-On-Demand™** power source cooling system operates only when needed, reducing noise, energy use and the amount of contaminants pulled through the machine.

**Auto-postflow** adjusts the length of postflow time based on the amperage setting, shielding your tungsten and eliminating the need to set the postflow time.

**Advanced squarewave AC** provides a fast freezing weld puddle and deeper penetration.

**Weldcraft™ A-150 torch with Diamond Grip™** provides more comfortable grip and reduces operator fatigue.

**Easy-to-understand operator interface.** Power up, select material type, set material thickness range and start welding!

**Inverter-based AC/DC power source** provides a more consistent welding arc while using less power.

**HF arc starting** for non-contact arc initiation that reduces tungsten and material contamination.

**Portable.** Easy to transport at 50 pounds.

\*While idling.

## Light industrial ● CC AC 1 DC Phase

**Process** - TIG (GTAW)

**Comes with**

- Power cord with MVP plugs for 120 V and 240 V
- 12.5 ft. (3.8 m) Weldcraft™ A-150 TIG torch
- 12 ft. (3.7 m) work cable with clamp
- RFCS-RJ45 remote foot control
- Flow gauge regulator with hose

**Most popular accessories**

- TIG Torch Accessory Kit AK2C (pg 67)
- Running Gear/Cylinder Rack 301239 (pg 118)
- Protective Cover 300579 (pg 124)
- RCCS-RJ45 Remote Fingertip Control 301146 (pg 124)
- RJ45 to 14-Pin Adapter Cord 300688
- Weldcraft™ Flexible Torch Body Kits (requires handle 105Z55R) A-125F (WP-9F) A-150F (WP-17F)

Visit [MillerWelds.com](http://MillerWelds.com) or your distributor for other Miller® options and accessories.

| AC/DC | Stock Number (907627)           | Input Power | Welding Amp Range | Rated Output                  | Amps Input at Rated Output | KVA        | KW         | Max. Open-Circuit Voltage | Dimensions  | Net Weight     |
|-------|---------------------------------|-------------|-------------------|-------------------------------|----------------------------|------------|------------|---------------------------|---|----------------|
|       |                                 | 115 V       | 10-125            | 125 A at 15 V, 35% duty cycle | 26.5 (.88*)                | 3.1 (.1*)  | 3.0 (.03*) | 80 VDC                    | H: 17 in. (433 mm)<br>W: 9.875 in. (251 mm)<br>D: 23.875 in. (608 mm) | 50 lb. (23 kg) |
|       |                                 | 230 V       | 10-180            | 150 A at 16 V, 20% duty cycle | 16 (.44*)                  | 3.7 (.1*)  | 3.6 (.03*) |                           |   |                |
|       | 180 A at 17.2 V, 10% duty cycle |             |                   | 20.5 (.44*)                   | 4.7 (.1*)                  | 4.6 (.03*) |            |                           |   |                |

# Maxstar® 161 STL and STH DC TIG and Stick

See literature DC/27.5

Maximum portability and performance provided in one compact TIG/stick package.



Maxstar 161 STH TIG/stick package with remote fingertip control shown – includes X-CASE.

### TIG Welding Capability

|                         |
|-------------------------|
| Max. 3/16 in. (4.8 mm)  |
| <b>Steel</b>            |
| Min. 0.020 in. (0.5 mm) |

**Two models available.** See page 49 in the Stick section for Maxstar 161 S. **STL:** DC TIG/stick with Lift-Arc™ starting without high frequency **STH:** DC TIG/stick with high frequency and Lift-Arc™ starting, plus built-in pulsing from 0-150 pulses per second

**AUTO-LINE TECHNOLOGY** Allows for any input voltage hookup (120-240 V) with no manual linking, providing convenience in any job setting.

**Portable with adjustable handle/shoulder strap.** Easy to transport at only 13 pounds.

**Built-in gas solenoid** eliminates need for a bulky torch with a gas valve.

**Digital meter** for more precise control.

**Fan-On-Demand™** power source cooling system.

**Superior stick arc performance** even on the difficult-to-run electrodes like E6010.

## Industrial ● CC DC 1 Phase

**Processes**

- TIG (GTAW) ■ Stick (SMAW)
- Pulsed TIG (GTAW-P) with STH model

**Comes with**

- 6.5 ft. (2 m) power cords for 120 V and 240 V
- 13 ft. (4 m) electrode cable with holder and 25 mm Dinse-style connector
- 10 ft. (3 m) work cable with clamp and 25 mm Dinse-style connector
- Air-cooled TIG torch connector
- Quick-reference guide

**TIG/stick packages include above plus**

- 12.5 ft. (3.8 m) Weldcraft™ A-150 TIG torch (WP1712RDI25)
- Protective X-CASE™ (301429)
- Flow gauge regulator with hose
- AK2C TIG torch accessory kit
- RCCS-6M remote fingertip control (packages 907710002 and 907711001 only)

Visit [MillerWelds.com](http://MillerWelds.com) or your distributor for Miller® options and accessories.

\*Sense voltage for stick and Lift-Arc™ TIG.

| DC    | Model/Stock Number                                | Model/Stock Number                   | Welding Process  | Input Power | Welding Amp Range | Rated Output                    | Amps Input at Rated Output, 50/60 Hz | KVA at Duty Cycle | KW   | Max. Open-Circuit Voltage | Dimensions          | Net Weight  |                 |
|-------|---|--------------------------------------|--|-------------|-------------------|---------------------------------|--------------------------------------|-------------------|------|---------------------------|---------------------|---|-----------------|
|       | <b>Maxstar 161 STL (907710)</b> Power source only | <b>(907710001)</b> TIG/stick package | <b>(907710002)</b> TIG/stick package with remote fingertip control | TIG         | 120 V             | 5-130                           | 130 A at 15.2 V, 30% duty cycle      | 22.6              | 2.73 | 2.70                      | 48 VDC (12-16 VDC*) | H: 10.3 in. (262 mm)<br>W: 5.6 in. (142 mm)<br>D: 13.5 in. (343 mm) | 13 lb. (5.9 kg) |
|       |   |                                      |  |             | 240 V             | 5-160                           | 160 A at 16.4 V, 20% duty cycle      | 15.05             | 3.62 | 3.49                      |                     |   |                 |
| Stick |   |                                      |  | 120 V       | 20-90             | 90 A at 23.6 V, 30% duty cycle  | 23.16                                | 2.78              | 2.76 |                           |                     |   |                 |
|       |   |                                      |  | 240 V       | 20-160            | 160 A at 26.4 V, 20% duty cycle | 22.55                                | 5.41              | 5.25 |                           |                     |   |                 |

# Syncrowave® 210

## AC/DC TIG, Stick and MIG (with Spool Gun)

See literature AD/4.6

Continuing the tradition of innovation through advanced inverter technology for light-industrial and personal users.

Syncrowave 210 TIG/stick only package shown.



See page 125



### Easy to use.

- 1) Turn power on.
- 2) Select the process.
- 3) Set amperage or voltage based on material thickness.

Then weld! It's easy as 1,2,3.

### TIG Welding Capability

Max. 1/4 in. (6.4 mm)

Steel Aluminum

Min. 0.020 in. (0.5 mm)

**AUTO-LINE TECHNOLOGY** Allows for any input voltage hookup (120–240 V) with no manual linking, providing convenience in any job setting. Ideal solution for dirty or unreliable power.



**Multi-voltage plug (MVP™)** allows for connection to 120- or 240-volt receptacles without tools. Choose the plug that fits the receptacle and connect it to the power cord.

**Low power draw.** Inverter-based power source provides full welding output from 240 volts while drawing less than 30 amps.

**High-frequency (HF) arc starting** for non-contact arc initiation, reducing tungsten and material contamination.

**Pro-Set™ (TIG/stick)** eliminates the guesswork when setting weld parameters. Use Pro-Set when you want the speed, convenience and confidence of preset controls.

**AC frequency (TIG)** controls the width of the arc cone and can improve directional control of the arc.

**AC balance (TIG)** control provides adjustable oxide removal which is essential for creating the highest quality aluminum welds.

**Pulse (TIG).** Pulsing can increase puddle agitation, arc stability and travel speeds while reducing heat input and distortion.

**DIG (stick)** control allows the arc characteristics to be changed for specific applications and electrodes. Lower the DIG setting for smooth running electrodes like E7018 and increase the DIG setting for stiffer, more penetrating electrodes like E6010.

**Auto-Set™ (MIG)** automatically sets your welder to the proper parameters. Simply set the wire size, material thickness, and shielding gas and you're ready to weld with the Spoolmate™ spool gun.

Light industrial ● CC AC 1 DC Phase

### Processes

- AC/DC TIG (GTAW) ▪ DC stick (SMAW)
- Pulsed TIG (GTAW-P) ▪ MIG (GMAW)\*
- Flux-cored (FCAW)\*

\*With Spoolmate 150.

### Comes with

- 10 ft. power cord with MVP plugs for 120 V and 240 V
- 12.5 ft. (3.8 m) Weldcraft™ A-150 TIG torch (WP1712MFDI50)
- 12 ft. (3.7 m) work cable with clamp and Dinse-style connector
- Electrode holder with Dinse-style connector
- RFCS-14 HD heavy-duty remote foot control
- Flow gauge regulator with hose
- Factory-installed running gear with EZ-Change™ low cylinder rack
- Quick-reference guide

### TIG/MIG Complete package includes above plus

- Spoolmate™ 150 spool gun (301272)
- 4-14 pin connector
- Flow-thru Dinse-style connector

### Most popular accessories

- 25 ft. (7.6 m) Weldcraft™ A-150 TIG Torch WP-17-25-R (pg 61)



- **TIG Torch Accessory Kit AK2C** (pg 67)

Includes one short back cap, one of each size (#4, #5, #6) alumina nozzle, and one of each size (.040, 1/16, 3/32 in.) of the following: collet, collet body, and 7-inch 2% ceriated tungsten electrode

- TIG Torch Accessory Kit AK-150MFC (pg 67)

Allows A-150 torch customization. Converts into 28 different torch styles while using existing cable. Includes collets, collet bodies, nozzles, torch heads, handle and more

- Protective Cover 195142 (pg 124)
- RCC-14 Remote Control 151086 (pg 124)
- Wireless Remote Foot Control 300429 (pg 125)

Visit [MillerWelds.com](http://MillerWelds.com) or your distributor for other Miller® options and accessories.

| Stock Number   | Input Power | Welding Process | Welding Amperage Range | Rated Output (R.M.S.)           | Amps Input at Rated Output | Max. Open-Circuit Voltage | Dimensions  | Net Weight   |
|--|-------------|-----------------|------------------------|---------------------------------|----------------------------|---------------------------|---|--|
| <b>(907596)</b> TIG/stick only package<br><b>(951684)</b> TIG/MIG Complete package<br>(includes Spoolmate 150) | 115 V       | DC TIG          | 5–125                  | 95 A at 13.8 V, 60% duty cycle  | 17.4 (.58 while idling)    | 47 VDC                    | H: 31.5 in. (800 mm)<br>W: 18.5 in. (470 mm)<br>D: 43 in. (1092 mm) | TIG/stick only:<br>133.5 lb. (61 kg)<br>TIG/MIG Complete:<br>139.5 lb. (63 kg) |
|  |             | AC TIG          | 5–125                  | 90 A at 13.6 V, 60% duty cycle  | 12.4 (.58 while idling)    |                           |   |  |
|  |             | DC stick        | 20–90                  | 70 A at 22.8 V, 60% duty cycle  | 20.5 (.58 while idling)    |                           |   |  |
|  | 230 V       | DC TIG          | 5–210                  | 125 A at 15 V, 60% duty cycle   | 11.9 (.35 while idling)    |                           |   |  |
|  |             | AC TIG          | 5–210                  | 114 A at 14.6 V, 60% duty cycle | 8.62 (.35 while idling)    |                           |   |  |
|  |             | DC stick        | 20–150                 | 90 A at 23.6 V, 60% duty cycle  | 11.9 (.35 while idling)    |                           |   |  |

# Syncrowave® 300 and 400

AC/DC TIG and Stick See literature AD/4.25 (300) and AD/4.28 (400)



### TIG Welding Capability

|                               |                               |
|-------------------------------|-------------------------------|
| 400 Max.<br>5/8 in. (15.9 mm) | 400 Max.<br>1/2 in. (12.7 mm) |
| 300 Max.<br>1/2 in. (12.7 mm) | 300 Max.<br>3/8 in. (9.5 mm)  |
| Steel                         | Aluminum                      |
| 0.012 in. (0.3 mm)            | 0.015 in. (0.4 mm)            |



See page 125

Industrial ● CC AC/DC Phase Phase 3 1

### Processes

- TIG (GTAW) ▪ Stick (SMAW)
- DC pulsed TIG (GTAW-P)

### Comes with

- 10 ft. (3 m) power cord (no plug)
- Two 50 mm Dinse-style connectors

### Complete packages include above plus

- Running gear
- Coolmate™ 3 cooler
- Coolant (four 1-gallon bottles)
- Remote control (foot or wireless foot)
- Weldcraft™ water-cooled torch kit  
Syncrowave 300: W-280  
Syncrowave 400: W-375

### Most popular accessories

- Coolant 043810 (pg 119)



### Weldcraft™ Water-Cooled Torch Kits

- (pg 124)
- 300990 W-280 (WP-280)
- 301268 W-375
- Remote Controls (pg 124-125)
- 043688 RCCS-14 fingertip control
- 194744 RFCS-14 HD foot control
- 300429 Wireless foot control

Visit [MillerWelds.com](http://MillerWelds.com) or your distributor for other Miller® options and accessories.

**Auto-Link®** circuit automatically links the power source to primary voltage being applied (208/240/480 V, single- or three-phase).

**AC balance control** features adjustable cleaning action while increasing arc stability on various aluminum alloys, and helps eliminate tungsten spitting and arc rectification.

**Blue Lightning™** high-frequency (HF) arc starter for non-contact arc initiation. Provides more consistent arc starts and greater reliability compared to traditional HF arc starters.

**Lift-Arc™** provides AC or DC arc initiation without the use of high frequency.

**Auto-postflow** adjusts the length of postflow time based on the amperage setting, shielding your tungsten and eliminating the need to set the postflow time.

**Pro-Set™** eliminates the guesswork when setting weld parameters. Use Pro-Set when you want the speed, convenience and confidence of preset controls.

**Arc timer/cycle counter** records actual welding time and number of arc starts. Great for estimating job costs.

**Line voltage compensation** keeps power source constant regardless of fluctuations in input power ( $\pm 10$  percent).

**Coolmate™ 3S cooler** (shown in Complete package). Three-gallon cooling system features a flow indicator to visually indicate system is working and an external filter to stop objects from entering the water-cooled torch cable.

<sup>1</sup>For Syncrowave 400 refer to owner's manual for 208 V output rating and duty cycle.

<sup>2</sup>Sense voltage for low OCV stick and Lift-Arc™ TIG.

<sup>3</sup>See literature AD/4.25 and AD/4.28 for Complete package dimensions and weight.

| AC/DC | Model/Stock Number   | Welding Process                  | Input Power | Welding Amp Range | Rated Output <sup>1</sup>       | Amps Input at Rated Output, 50/60 Hz |       |       |      |     | Max. Open-Circuit Voltage     | Power Source Dimensions <sup>2</sup>                               | Power Source Net Weight <sup>3</sup> |
|-------|--|----------------------------------|-------------|-------------------|---------------------------------|--------------------------------------|-------|-------|------|-----|-------------------------------|--|--------------------------------------|
|       |  |                                  |             |                   |                                 | 208 V                                | 240 V | 480 V | KVA  | KW  |                               |  |                                      |
| AC/DC | Syncrowave 300 (907782) Power source only (951829) Complete w/foot (951830) Complete w/wireless foot | TIG (includes cooler power draw) | 3-phase     | 5-300             | 210 A at 18.4 V, 60% duty cycle | 16                                   | 14    | 7     | 5.9  | 5.5 | 60 VDC (13 VDC <sup>2</sup> ) | H: 29.4 in. (746 mm)<br>W: 15 in. (381 mm)<br>D: 24.6 in. (625 mm) | 101 lb. (45.8 kg)                    |
|       |  |                                  | 1-phase     |                   |                                 | 27                                   | 24    | 12    | 5.7  | 5.5 |                               |  |                                      |
|       |  | Stick                            | 3-phase     | 5-230             | 160 A at 26.4 V, 60% duty cycle | 16                                   | 11    | 5     | 5.7  | 5.5 |                               |  |                                      |
|       |  |                                  | 1-phase     |                   |                                 | 27                                   | 23    | 11    | 5.7  | 5.5 |                               |  |                                      |
| AC/DC | Syncrowave 400 (907783) Power source only (951831) Complete w/foot (951832) Complete w/wireless foot | TIG (includes cooler power draw) | 3-phase     | 5-400             | 300 A at 22 V, 60% duty cycle   | 25                                   | 23    | 11    | 9.1  | 8.8 | 70 VDC (13 VDC <sup>2</sup> ) | H: 29.4 in. (746 mm)<br>W: 15 in. (381 mm)<br>D: 24.6 in. (625 mm) | 131 lb. (59.4 kg)                    |
|       |  |                                  | 1-phase     |                   |                                 | 43                                   | 42    | 20    | 9.7  | 8.9 |                               |  |                                      |
|       |  | Stick                            | 3-phase     | 5-300             | 250 A at 30 V, 60% duty cycle   | 27                                   | 24    | 12    | 9.8  | 9.4 |                               |  |                                      |
|       |  |                                  | 1-phase     |                   |                                 | 47                                   | 43    | 21    | 10.4 | 9.5 |                               |  |                                      |

# Maxstar® and Dynasty® 210/280 Series

## DC (Maxstar) and AC/DC (Dynasty) TIG and Stick

See literature DC/32.1 (Maxstar 210), DC/35.0 (Maxstar 280), AD/4.81 (Dynasty 210) and AD/4.9 (Dynasty 280)



Maxstar and Dynasty  
210 Series (Maxstar 210 shown).

Dynasty 280 DX



See page 125

### 210 Series TIG Welding Capability

|                          |                            |
|--------------------------|----------------------------|
| Max. 1/4 in. (6.4 mm)    | Max. 1/4 in. (6.4 mm)      |
| Steel                    | Aluminum<br>(Dynasty only) |
| Min. 0.002 in. (0.05 mm) | Min. 0.012 in. (0.3 mm)    |

### 280 Series TIG Welding Capability

|                         |                            |
|-------------------------|----------------------------|
| Max. 3/8 in. (9.5 mm)   | Max. 3/8 in. (9.5 mm)      |
| Steel                   | Aluminum<br>(Dynasty only) |
| Min. 0.004 in. (0.1 mm) | Min. 0.012 in. (0.3 mm)    |

**Base and DX models available.** Base model provides essential TIG and stick functions. DX model adds extended ranges to sequencer, full trigger options, and full preflow and pulser functions.

Note: See page 41 in the Multiprocess section for the Maxstar 280 Multiprocess and Dynasty 280 DX Multiprocess, and see page 50 in the Stick section for the Maxstar 210 STR.

**AUTO-LINE** TECHNOLOGY Allows for any input voltage hookup (210 models: 120–480 V, 280 models: 208–575 V) with no manual linking, providing convenience in any job setting. Ideal solution for dirty or unreliable power.

**Blue Lightning™** high-frequency (HF) arc starter for non-contact arc initiation. Provides more consistent arc starts and greater reliability compared to traditional HF arc starters.

**Lift-Arc™** provides AC or DC arc initiation without the use of high frequency.

**Hot Start™** adaptive control provides positive arc starts without sticking.

**Auto-postflow** adjusts the length of postflow time based on the amperage setting, shielding your tungsten and eliminating the need to set the postflow time.

**Pro-Set™** eliminates the guesswork when setting weld parameters. Use Pro-Set when you want the speed, convenience and confidence of preset controls. Simply select the feature and adjust until Pro-Set appears on the display.

**Sleep timer** conserves electricity. This programmable feature will power down the machine if it sits idle for a specified time.

**Update and expand.** Front panel memory card data port provides the ability to easily update software and expand product features.

**Optional cooler power supply (CPS)** is an integrated 120-volt dedicated-use receptacle for the Coolmate™ 1.3. *Not available on Maxstar 210 Series.*

**Cooler-On-Demand™** feature operates the auxiliary cooling system only when needed. Reduces noise, energy use, and airborne contaminants pulled through the cooler. *Only available on CPS models.*

\*Refer to owner's manual for complete ratings.

\*\*Sense voltage for low OCV stick and Lift-Arc™ TIG.

| Model/<br>Stock Number  | Welding<br>Process | Input Power     | Welding<br>Amp Range | Rated Output at<br>60% Duty Cycle | Amps Input at Rated Load Output, 50/60 Hz |       |       |       |       |       |       |       | Max. Open-<br>Circuit Voltage | Dimensions | Net<br>Weight        |  |  |
|---|--------------------|-----------------|----------------------|-----------------------------------|---|-------|-------|-------|-------|-------|-------|-------|-------------------------------|------------|----------------------|--|--|
|   |                    |                 |                      |                                   | 120 V                                     | 208 V | 230 V | 240 V | 400 V | 460 V | 480 V | 575 V |                               |            |                      | KVA  | KW   |
| DC Maxstar<br>Maxstar 210<br>(907683)<br>Maxstar 210 DX<br>(907684)                             | TIG                | 3-phase         | 1-210                | 210 A at 18.4 V                   | –   | 14    | –     | 12    | 7     | –     | 6     | –     | 5.2                           | 4.9        | 80 VDC<br>(11 VDC**) | H: 13.6 in.<br>(346 mm)<br>W: 8.6 in.<br>(219 mm)<br>D: 19.5 in.<br>(495 mm) | 38 lb.<br>(17.2 kg)                                    |
|   |                    |                 | 1-210                | 210 A at 18.4 V                   | –   | 24    | –     | 20    | 12    | –     | 10    | –     | 4.9                           | 4.9        |                      |  |  |
|   |                    | 1-phase (120 V) | 1-150                | 125 A at 15 V                     | 22  | –     | –     | –     | –     | –     | –     | –     | 2.6                           | 2.6        |                      |  |  |
|   | Stick              | 3-phase         | 5-210                | 160 A at 26.4 V                   | –   | 15    | –     | 13    | 8     | –     | 6     | –     | 5.5                           | 5.2        |                      |  |  |
|   |                    |                 | 1-phase              | 5-210                             | 160 A at 26.4 V                           | –     | 26    | –     | 22    | 13    | –     | 11    | –                             | 5.3        |                      |  |  |
|   |                    | 1-phase (120 V) | 5-100                | 90 A at 23.6 V                    | 23  | –     | –     | –     | –     | –     | –     | –     | 2.8                           | 2.8        |                      |  |  |
| Maxstar 280<br>(907552)<br>(907538) with CPS<br>Maxstar 280 DX<br>(907553)<br>(907539) with CPS | TIG                | 3-phase         | 1-280                | 250 A at 20 V                     | –   | 21    | 19    | –     | 11    | 9     | –     | 7     | 7.6                           | 7.3        | 60 VDC<br>(11 VDC**) | H: 13.6 in.<br>(346 mm)<br>W: 8.6 in.<br>(219 mm)<br>D: 22.5 in.<br>(569 mm) | 47 lb.<br>(21.3 kg)<br>50 lb.<br>(22.7 kg)<br>with CPS |
|   |                    |                 | 1-phase              | 1-280                             | 250 A at 20 V                             | –     | 35    | 32    | –     | 18    | 16    | –     | 13                            | 7.3        |                      |  |  |
|   | Stick              | 3-phase         | 5-280                | 250 A at 30 V                     | –   | *     | *     | –     | 14    | 13    | –     | 10    | 9.9                           | 9.6        |                      |  |  |
|   |                    |                 | 1-phase              | 5-280                             | 180 A at 27.2 V                           | –     | 32    | 29    | –     | *     | *     | –     | 6.7                           | 6.5        |                      |  |  |
|   |                    | 1-phase (120 V) | 5-280                | 180 A at 27.2 V                   | –   | 32    | 29    | –     | *     | *     | –     | *     | 6.7                           | 6.5        |                      |  |  |
|   |                    |                 | 5-280                | 180 A at 27.2 V                   | –   | 32    | 29    | –     | *     | *     | –     | *     | 6.7                           | 6.5        |                      |  |  |



**Industrial**   
**CC** <sup>AC</sup> **3** **1** <sup>DC</sup> <sup>Phase</sup> <sup>Phase</sup> Maxstar is DC only

**Processes**

- TIG (GTAW) ▪ Stick (SMAW)
- Pulsed TIG (GTAW-P)
- Air carbon arc (CAC-A) w/280 models

**Comes with**

- 8 ft. (2.4 m) power cord (no plug)
- Two 50 mm Dinse-style connectors
- Quick-reference guide (Dynasty only)

**Complete packages come with**

- 8 ft. (2.4 m) power cord (no plug)
- Quick-reference guide
- Small Runner™ cart
- Coolmate™ 1.3
- Coolant (four 1-gallon bottles)
- Remote control (foot or wireless foot)
- Weldcraft™ water-cooled torch kit  
 Dynasty 210: W-250  
 Dynasty 280: W-280

**Most popular accessories**

- 2-Wheel Trolley Cart 300971 (pg 119)
- Small Runner™ Cart 301318 (pg 119)
- Coolmate™ 1.3 300972 (pg 119)
- Coolant 043810 (pg 119)



▪ **Contractor Kits** (pg 124)

- 301309 A-150 w/RFCS-14 HD
- 301311 A-150 w/RCCS-14
- 301549 A-200 w/RFCS-14 HD
- 301550 A-200 w/RCCS-14



▪ **Weldcraft™ Water-Cooled Torch Kits** (pg 124)

- 300185 W-250 (WP-20)
- 300990 W-280 (WP-280)
- 301268 W-375

- Remote Controls (pg 124-125)  
 043688 RCCS-14 fingertip control  
 194744 RFCS-14 HD foot control  
 300429 Wireless foot control

Visit [MillerWelds.com](http://MillerWelds.com) or your distributor for other Miller® options and accessories.

**Dynasty welders add AC TIG capabilities and the following AC features (limited on base model)**

**Waveforms** for advanced squarewave, soft squarewave, sine wave and triangular wave.

**Balance** control provides adjustable oxide removal which is essential for creating the highest quality aluminum welds. DX models provide extended ranges.

**Frequency** controls the width of the arc cone and can improve directional control of the arc.



Dynasty 280 DX Complete package with wireless foot control and CPS shown.

**Dynasty Water-Cooled Complete Packages**

Additional packages are available — visit [MillerWelds.com](http://MillerWelds.com) or your distributor.

| Model          | Packages with Foot Control and CPS | Packages with Wireless Foot Control and CPS |
|----------------|------------------------------------|---|
| Dynasty 210    | (951666)                           | (951667)                                    |
| Dynasty 210 DX | (951668)                           | (951669)                                    |
| Dynasty 280    | (951466)                           | —   |
| Dynasty 280 DX | (951468)                           | (951469)                                    |

\*Refer to owner's manual for complete ratings.  
 \*\*Sense voltage for low OCV stick and Lift-Arc™ TIG.

| AC/DC Dynasty | Model/Stock Number  | Welding Process | Input Power     | Welding Amp Range        | Rated Output at 60% Duty Cycle | Amps Input at Rated Load Output, 50/60 Hz |       |       |       |       |       |       | Max. Open-Circuit Voltage | Dimensions | Net Weight |                   |   |   |     |
|---------------|---|-----------------|-----------------|--------------------------|--------------------------------|---|-------|-------|-------|-------|-------|-------|---------------------------|------------|------------|-------------------|---|---|-----|
|               |   |                 |                 |                          |                                | 120 V                                     | 208 V | 230 V | 240 V | 400 V | 460 V | 480 V |                           |            |            | 575 V             | KVA   | KW  |     |
|               | Dynasty 210 (907685) (907685002) with CPS<br>Dynasty 210 DX (907686) (907686002) with CPS | TIG             | 3-phase         | 1-210                    | 210 A at 18.4 V                | —   | 14    | —     | 12    | 7     | —     | 6     | —                         | 5.2        | 4.9        | 80 VDC (11 VDC**) | H: 13.6 in. (346 mm)<br>W: 8.6 in. (219 mm)<br>D: 22.5 in. (569 mm) | 47 lb. (21.3 kg)<br>50 lb. (22.7 kg) with CPS |     |
|               |   |                 | 1-phase         | 1-210                    | 210 A at 18.4 V                | —   | 24    | —     | 20    | 12    | —     | 10    | —                         | 4.9        | 4.9        |                   |   |   |     |
|               |   |                 | 1-phase (120 V) | 1-150                    | 125 A at 15 V                  | 22  | —     | —     | —     | —     | —     | —     | —                         | —          | 2.6        |                   |   |   | 2.6 |
|               |   | Stick           | 3-phase         | 5-210                    | 160 A at 26.4 V                | —   | 15    | —     | 13    | 8     | —     | 6     | —                         | —          | 5.5        |                   |   |   | 5.2 |
|               |   |                 | 1-phase         | 5-210                    | 160 A at 26.4 V                | —   | 26    | —     | 22    | 13    | —     | 11    | —                         | —          | 5.3        |                   |   |   | 5.3 |
|               |   |                 | 1-phase (120 V) | 5-100                    | 90 A at 23.6 V                 | 23  | —     | —     | —     | —     | —     | —     | —                         | —          | 2.8        |                   |   |   | 2.8 |
|               | Dynasty 280 (907550) (907537) with CPS<br>Dynasty 280 DX (907551) (907514) with CPS       | TIG             | 3-phase         | 2-280 (AC)<br>1-280 (DC) | 250 A at 20 V                  | —   | 21    | 19    | —     | 11    | 9     | —     | 7                         | 7.6        | 7.3        | 60 VDC (11 VDC**) | H: 13.6 in. (346 mm)<br>W: 8.6 in. (219 mm)<br>D: 22.5 in. (569 mm) | 52 lb. (23.6 kg)<br>55 lb. (25 kg) with CPS   |     |
|               |   |                 | 1-phase         | 2-280 (AC)<br>1-280 (DC) | 250 A at 20 V                  | —   | 35    | 32    | —     | 18    | 16    | —     | 13                        | 7.3        | 7.1        |                   |   |   |     |
|               |   | Stick           | 3-phase         | 5-280                    | 250 A at 30 V                  | —   | *     | *     | —     | 14    | 13    | —     | 10                        | 9.9        | 9.6        |                   |   |   |     |
|               |   |                 | 1-phase         | 5-280                    | 180 A at 27.2 V                | —   | 32    | 29    | —     | *     | *     | —     | *                         | 6.7        | 6.5        |                   |   |   |     |

# Maxstar® and Dynasty® 400 and 800 DC (Maxstar) and AC/DC (Dynasty) TIG and Stick

See literature DC/24.5 (Maxstar) and AD/5.5 (Dynasty)



Dynasty 400

Dynasty 800



See page 125

## TIG Welding Capability

| 800 Max.<br>1 in. (25.4 mm)    | 800 Max.<br>1 in. (25.4 mm)    |
|--------------------------------|--------------------------------|
| 400 Max.<br>5/8 in. (15.9 mm)  | 400 Max.<br>5/8 in. (15.9 mm)  |
| Steel                          | Aluminum<br>(Dynasty only)     |
| 400 Min.<br>0.012 in. (0.3 mm) | 400 Min.<br>0.015 in. (0.4 mm) |
| 800 Min.<br>0.020 in. (0.5 mm) | 800 Min.<br>0.020 in. (0.5 mm) |

## Dynasty welders add AC TIG capabilities and the following AC features

**Waveforms** for advanced squarewave, soft squarewave, sine wave and triangular wave.

**Balance** control provides adjustable oxide removal which is essential for creating the highest quality aluminum welds.

**Frequency** controls the width of the arc cone and can improve directional control of the arc.

**AC amplitude/amperage** allows EP and EN amperages to be set independently to precisely control heat input to the work and electrode.

Dynasty 400 Complete package with wireless foot control shown.



**Heavy industrial**  
 Maxstar is DC only

## Processes

- TIG (GTAW) ▪ Stick (SMAW)
- Pulsed TIG (GTAW-P)
- Air carbon arc (CAC-A)

## 400 models come with

- 8 ft. (2.4 m) power cord (no plug)
- Two 50 mm Dinse-style connectors
- Quick-reference guide (Dynasty only)

## 800 models come with

- Thread-lock torch connector
- Two thread-lock weld cable connectors
- Quick-reference guide (Dynasty only)

Note: Power cord is NOT included with 800 models.

## Complete packages include above plus

- Runner™ cart
- Coolmate™ 3.5
- Coolant (four 1-gallon bottles)
- Remote control (foot or wireless foot)
- Weldcraft™ water-cooled torch kit  
Maxstar/Dynasty 400: W-375  
Dynasty 800: W-400

## Most popular accessories

- Runner™ Cart 300244 (pg 119)
- Coolmate™ 3.5 300245 (pg 119)
- Coolant 043810 (pg 119)



## Weldcraft™ Water-Cooled Torch Kits (pg 124)

- 300185 W-250 (WP-20)
- 300990 W-280 (WP-280)
- 301268 W-375
- 300186 W-400 (WP-18SC)
- Remote Controls (pg 124-125)  
043688 RCCS-14 fingertip control  
194744 RFCS-14 HD foot control  
300429 Wireless foot control

Visit [MillerWelds.com](http://MillerWelds.com) or your distributor for other Miller® options and accessories.

**AUTO-LINE TECHNOLOGY** Allows for any input voltage hookup (208-575 V) with no manual linking, providing convenience in any job setting. Ideal solution for dirty or unreliable power.

**Blue Lightning™** high-frequency (HF) arc starter for non-contact arc initiation. Provides more consistent arc starts and greater reliability compared to traditional HF arc starters.

**Lift-Arc™** provides AC or DC arc initiation without the use of high frequency.

**Hot Start™** adaptive control provides positive arc starts without sticking.

**Auto-postflow** adjusts the length of postflow time based on the amperage setting, shielding your tungsten and eliminating the need to set the postflow time.

**Cooler power supply (CPS)** is an integrated 120-volt dedicated-use receptacle for the Coolmate™ 3.5.

**Program memory** features nine independent program memories that maintain/save your parameters.

**High-speed DC TIG pulse controls** capable of 5,000 pulses per second.

\*Sense voltage for low OCV stick and Lift-Arc™ TIG.

\*\*See literature DC/24.5 and AD/5.5 for Complete package dimensions and weight.

|               | Model/Stock Number  | Welding Process | Input Power | Welding Amp Range | Rated Output                  | Amps Input at Rated Load Output, 50/60 Hz |       |       |       |       |      | Max. Open-Circuit Voltage | Power Source Dimensions** | Power Source Net Weight**  |                 |
|---------------|---|-----------------|-------------|-------------------|-------------------------------|---|-------|-------|-------|-------|------|---------------------------|---------------------------|--|-----------------|
|               |   |                 |             |                   |                               | 208 V                                     | 230 V | 400 V | 460 V | 575 V | KVA  |                           |                           |  | KW              |
| DC Maxstar    | Maxstar 400 (907716) Power source only<br>(951692) Complete w/foot<br>(951693) Complete w/wireless foot | TIG/stick       | 3-phase     | 3-400             | 300 A at 32 V, 60% duty cycle | 33  | 30    | 17    | 15    | 12    | 12.0 | 11.6                      | 75 VDC (10-15 VDC*)       | H: 24.75 in. (629 mm)<br>W: 13.75 in. (349 mm)<br>D: 22 in. (559 mm) | 134 lb. (61 kg) |
|               |   |                 |             |                   | 250 A at 30 V, 60% duty cycle | 48  | 43    | 24    | 20    | 16    | 10   | 9.2                       |                           |  |                 |
|               | Maxstar 800 (907718) Power source only  | TIG/stick       | 3-phase     | 5-800             | 600 A at 44 V, 60% duty cycle | 90  | 80    | 45    | 39    | 31    | 32   | 31                        | 75 VDC (10-15 VDC*)       | H: 34.5 in. (876 mm)<br>W: 13.75 in. (349 mm)<br>D: 22 in. (559 mm)  | 198 lb. (90 kg) |
|               |   |                 |             |                   | 500 A at 40 V, 60% duty cycle | 126                                       | 112   | 61    | 53    | 41    | 26   | 24                        |                           |  |                 |
| AC/DC Dynasty | Dynasty 400 (907717) Power source only<br>(951694) Complete w/foot<br>(951695) Complete w/wireless foot | TIG/stick       | 3-phase     | 3-400             | 300 A at 32 V, 60% duty cycle | 36  | 33    | 19    | 16    | 13    | 13.1 | 12.5                      | 75 VDC (10-15 VDC*)       | H: 24.75 in. (629 mm)<br>W: 13.75 in. (349 mm)<br>D: 22 in. (559 mm) | 134 lb. (61 kg) |
|               |   |                 |             |                   | 250 A at 29 V, 60% duty cycle | 52  | 47    | 26    | 22    | 17    | 10.9 | 9.9                       |                           |  |                 |
|               | Dynasty 800 (907719) Power source only<br>(951696) Complete w/foot<br>(951697) Complete w/wireless foot | TIG/stick       | 3-phase     | 5-800             | 600 A at 44 V, 60% duty cycle | 96  | 86    | 48    | 42    | 33    | 35   | 33                        | 75 VDC (10-15 VDC*)       | H: 34.5 in. (876 mm)<br>W: 13.75 in. (349 mm)<br>D: 22 in. (559 mm)  | 198 lb. (90 kg) |
|               |   |                 |             |                   | 500 A at 40 V, 60% duty cycle | 136                                       | 122   | 66    | 56    | 44    | 28   | 26                        |                           |  |                 |

# Weldcraft™ Series TIG Torches

Synonymous with versatility and performance, Weldcraft TIG torches can handle the most intricate to the most demanding TIG welding challenges. From the 125-amp hand-held MicroTIG® torch to the 500-amp machine-held water-cooled models, there's a Weldcraft torch for nearly every TIG application.

For more detailed information, visit [MillerWelds.com/tigtorches](http://MillerWelds.com/tigtorches)



## Setting the standard for performance

- Super Cool™ technology** provides additional surface area to increase cooling efficiency and capacity.
- Comfort and control** are increased with the lightweight, well-balanced body and handle designs, helping to reduce fatigue.
- Robust performance** through heavy copper construction that delivers maximum welding capacity for rugged fieldwork.
- Simplify torch package installation** with ColorSmart™ hose and cable sets that differentiate input water, water/power cable, and gas hoses.
- Improve gas coverage and cooling capacity** through the use of a gas lens.

## Extreme reliability

- Reduce downtime** due to overheating through consistent water-cooled performance.
- Extend parts life** using the durable copper components, maximizing current capacity.
- Reduce leakage** of gas and water through secure mechanical fittings.
- Works in cold weather** with the Tri-Flex™ hose and cable assembly that remains flexible to ease handling and extends cable life.

# TIG TORCH CONFIGURATOR

**MAKE SURE YOU ARE USING THE RIGHT TORCH AND CONSUMABLES FOR YOUR APPLICATION.**

Answer a few simple questions about your specific application and get a recommendation for the appropriate torch, tungsten, collet, collet body and more. Email or print the recommendation for reference when purchasing your next Weldcraft torch.

Visit now at [MillerWelds.com/torchconfig](http://MillerWelds.com/torchconfig)

**Miller. Torch Product Selector**

Choose Products

Torches Only

Consumables Only

Both Torches and Consumables

**Miller. Torch Product Selector**

Work Material

Mild Steel/Stainless Steel

Deoxidized Copper

Titanium

Magnesium

Aluminum

**Miller. Torch Product Selector**

| Part Number | Description                               | Quantity |
|-------------|---|----------|
| WC332X7     | 2% Ceriated Tungsten (3/32" dia.)         | 1        |
| 54N63       | Large Diameter GL Insulator               | 1        |
| 52N88XXL    | #10 Large Dia. GL Alumina Nozzle XXL Long | 1        |
| 10N24       | Collet for 3/32" dia. Tungsten            | 1        |
| 45V64       | Large Gas Lens for 3/32" dia. Tungsten    | 1        |
| 300M        | Medium Back Cap                           | 1        |

## Weldcraft™ Air-Cooled Torches

**Recommended for welding amperages under 250 amps.** Air-cooled torches are great for portable applications as they do not require a water-circulator. For power sources without a built-in gas solenoid, the air-cooled two-piece torch is the solution of choice.

## Weldcraft™ Water-Cooled Torches

**Recommended for welding amperages above 200 amps.** Offering a small torch design, water-cooled torches allow for precise control due to the efficient around-the-head cooling. This same cooling allows for extended torch life and higher amperage capacities.

## Weldcraft™ Specialty Torches

**Specialty torches are designed to fit best in unique applications.** The **Modular Series** torches allow for a quick change to many different torch styles for any joint configuration. For those hard-to-reach areas the **W-125 MicroTIG®** torch provides access and superior maneuverability.

## Weldcraft™ Automation Torches

**Ideal for mechanized applications,** the Weldcraft Automation Series offers air-cooled and water-cooled torches designed for high- and low-amperage mechanized applications.

### Process

- TIG (GTAW)

### Suggested power sources

- Multimatic® 200/215 (pg 37) (A-150)
- Multimatic® 220 AC/DC (pg 38) (A-150)
- Multimatic® 235 (pg 39) (A-150)
- Multimatic® 255 (pg 40) (A-150)
- Maxstar® 280 Multiprocess (pg 41) (A-200, A-250, W-280)
- Dynasty® 280 DX Multiprocess (pg 41) (A-200, A-250, W-280)
- XMT Series (pg 42-45) (A-200, A-250)
- CST™ 282 (pg 51) (A-250)
- Maxstar® 161 STL/STH (pg 53) (A-150)
- Syncrowave® 210 (pg 54) (A-150)
- Syncrowave® 300 (pg 55) (W-280)
- Syncrowave® 400 (pg 55) (W-375)
- Maxstar®/ Dynasty® 210 (pg 56) (A-150, W-250)
- Maxstar®/ Dynasty® 280 (pg 56) (A-200, A-250, W-280)
- Maxstar®/ Dynasty® 400 (pg 58) (W-375)
- Maxstar®/ Dynasty® 800 (pg 58) (W-400)

# Weldcraft™ A-80 Series

See literature AY/21.0

Formerly known as WP-24 Series

**Innovative air-cooled torches designed for intricate welding applications, especially in limited-access areas and on thin-gauge materials.**

**Featherweight torch body** is well balanced to improve operator comfort and control.

**Minimize discontinuities.** Insulating gasket on torch body minimizes gas leakage and minimizes weld discontinuities.

**Combined flexible neck and gas valve** is ideal for optimal positioning and gas flow control (A-80 Flex Valve).



### Applications

- Shipbuilding
- Motorsports
- Aerospace
- Restricted areas

### Most popular consumables

- Collets
  - 53N16 .040 in. (1.0 mm)
  - 53N14 1/16 in. (1.6 mm)
  - 24C332 3/32 in. (2.4 mm)
- Collet Bodies
  - 53N18 .040 in. (1.0 mm)
  - 53N19 1/16 in. (1.6 mm)
  - 24CB332 3/32 in. (2.4 mm)
- Alumina Nozzles
  - A53N24 #4, 1/4 in.
  - A53N25 #5, 5/16 in.
  - A53N27 #6, 3/8 in.

### Most popular accessories

- Collet Body Wrench 53N20

Visit [MillerWelds.com](http://MillerWelds.com) or your distributor for other Miller® options and accessories.

| Model           | Rubber           |                | Type       | Rated Output   | Electrode Range            |
|-----------------|------------------|----------------|------------|--|----------------------------|
|                 | 12.5 ft. (3.8 m) | 25 ft. (7.6 m) |            |  |                            |
| A-80 Flex       | WP-24F-12-R      | WP-24F-25-R    | Air-cooled | DC: 80 A at 60% duty cycle<br>AC: 50 A at 60% duty cycle | .020-3/32 in. (0.5-2.4 mm) |
| A-80 Flex Valve | WP-24FV-12-R     | WP-24FV-25-R   |            |  |                            |

# Weldcraft™ A-125 Series

Formerly known as WP-9 Series

See literature AY/22.0



**Air-cooled torches designed for optimal control while welding thin-gauge materials, especially in hard-to-reach places.**

**Lightweight body** reduces fatigue and downtime, while increasing operator comfort.

**Pencil-style model** without a back cap allows for superior access to confined areas (A-125 Pencil).

**Combined flexible neck and gas valve** for welding limited-access joints using power sources without gas solenoids (A-125 Flex Valve).

### Applications

- Maintenance and repair
- Home/hobby ▪ Motorsports
- Metal art ▪ Fabrication

### Most popular consumables

- Collets
  - 13N22 1/16 in. (1.6 mm)
  - 13N23 3/32 in. (2.4 mm)
  - 13N24 1/8 in. (3.2 mm)
- Collet Bodies
  - 13N27 1/16 in. (1.6 mm)
  - 13N28 3/32 in. (2.4 mm)
  - 13N29 1/8 in. (3.2 mm)
- Alumina Nozzles
  - 13N10 #6, 3/8 in.
  - 13N11 #7, 7/16 in.
  - 13N12 #8, 1/2 in.

### Most popular accessories

- Accessory Kit AK1C (pg 67)
- Visit [MillerWelds.com](http://MillerWelds.com) or your distributor for other Miller® options and accessories.

| Model            | Rubber<br>12.5 ft. (3.8 m) |                | 2-Piece Rubber<br>12.5 ft. (3.8 m) |                | Type       | Rated Output   | Electrode Range           |
|------------------|----------------------------|----------------|------------------------------------|----------------|------------|--|---------------------------|
|                  | 25 ft. (7.6 m)             | 25 ft. (7.6 m) | 25 ft. (7.6 m)                     | 25 ft. (7.6 m) |            |  |                           |
| A-125            | WP-9-12-R                  | WP-9-25-R      | –                                  | –              | Air-cooled | DC: 125 A at 60% duty cycle<br>AC: 100 A at 60% duty cycle | .020–1/8 in. (0.5–3.2 mm) |
| A-125 Valve      | WP-9V-12-R                 | WP-9V-25-R     | –                                  | WP-9V-25-2     |            |  |                           |
| A-125 Flex       | WP-9F-12-R                 | WP-9F-25-R     | WP-9F-12-2                         | WP-9F-25-2     |            |  |                           |
| A-125 Flex Valve | WP-9FV-12-R                | WP-9FV-25-R    | –                                  | WP-9FV-25-2    |            |  |                           |
| A-125 Pencil     | WP-9P-12-R                 | WP-9P-25-R     | –                                  | –              |            |  |                           |

# Weldcraft™ A-150 Series

Formerly known as WP-17 Series

See literature AY/23.0

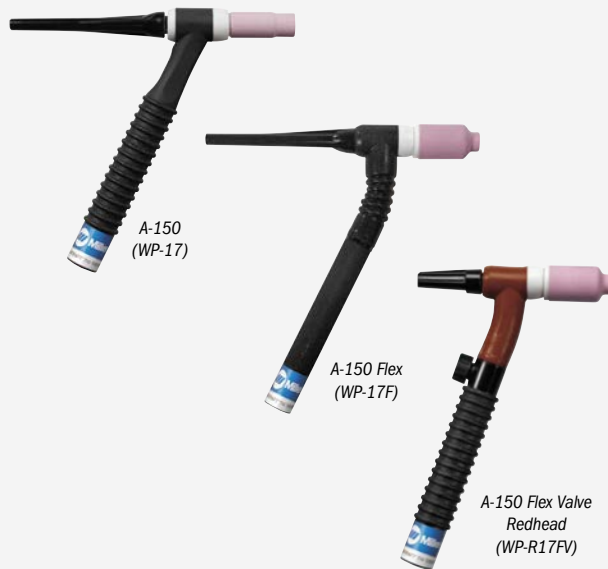

**Versatile and innovative air-cooled torches designed for maximum comfort in a variety of applications.**

**Diamond Grip™ head design** has ergonomic contact points for thumb and fingers. Provides a more comfortable grip and reduces operator fatigue (A-150 and A-150 Valve).

**Improve control and comfort** with a flexible neck that allows access into hard-to-reach areas (A-150 Flex).

**Maximum versatility.** Utilize the Redhead™ Series torches in a variety of welding applications without adding expenses.

### Applications

- Fabrication ▪ Maintenance and repair
- Aerospace ▪ Food/beverage industry
- Metal art ▪ Petro/chemical
- Shipbuilding

### Most popular consumables

- Collets
  - 10N23 1/16 in. (1.6 mm)
  - 10N24 3/32 in. (2.4 mm)
  - 10N25 1/8 in. (3.2 mm)
- Collet Bodies
  - 10N31 1/16 in. (1.6 mm)
  - 10N32 3/32 in. (2.4 mm)
  - 10N28 1/8 in. (3.2 mm)
- Alumina Nozzles
  - 10N48 #6, 3/8 in.
  - 10N47 #7, 7/16 in.
  - 10N46 #8, 1/2 in.

### Most popular accessories

- Accessory Kit AK-150MFC (pg 67)
- Converts A-150 into 28 different torch styles while using existing cable — includes collets, collet bodies, nozzles, torch heads, handle and more
- Visit [MillerWelds.com](http://MillerWelds.com) or your distributor for other Miller® options and accessories.

| Model                    | Rubber<br>12.5 ft. (3.8 m) |                | Mono-Flex™<br>12.5 ft. (3.8 m) |                | 2-Piece Rubber<br>12.5 ft. (3.8 m) |                | Type       | Rated Output   | Electrode Range           |
|--------------------------|----------------------------|----------------|--------------------------------|----------------|------------------------------------|----------------|------------|--|---------------------------|
|                          | 25 ft. (7.6 m)             | 25 ft. (7.6 m) | 25 ft. (7.6 m)                 | 25 ft. (7.6 m) | 25 ft. (7.6 m)                     | 25 ft. (7.6 m) |            |  |                           |
| A-150                    | WP-17-12-R                 | WP-17-25-R     | WP-17-12-MF                    | WP-17-25-MF    | WP-17-12-2                         | WP-17-25-2     | Air-cooled | DC: 150 A at 60% duty cycle<br>AC: 115 A at 60% duty cycle | .020–1/8 in. (0.5–3.2 mm) |
| A-150 Valve              | WP-17V-12-R                | WP-17V-25-R    | WP-17V-12-MF                   | WP-17V-25-MF   | WP-17V-12-2                        | WP-17V-25-2    |            |  |                           |
| A-150 Flex               | WP-17F-12-R                | WP-17F-25-R    | –                              | –              | –                                  | WP-17F-25-2    |            |  |                           |
| A-150 Flex Valve         | WP-17FV-12-R               | WP-17FV-25-R   | –                              | –              | WP-17FV-12-2                       | WP-17FV-25-2   |            |  |                           |
| A-150 Flex Valve Redhead | WP-R17FV-12-R              | WP-R17FV-25-R  | –                              | –              | –                                  | –              |            |  |                           |

# Weldcraft™ A-200 Series

Formerly known as WP-26 Series

See literature AY/24.0



**Dependable, top-performing air-cooled torches designed for heavy-duty welding applications.**

**Eliminate the expense** of a water-cooled system. The air-cooled capability of the A-200 Series pairs reliability with cost-effectiveness for all field applications.

**Combined flexible neck and gas valve** advances capabilities with greater comfort and control (A-200 Flex Valve).

**Maximum versatility.** Utilize the Redhead Series torches in a variety of welding applications without adding expenses.

| Model                    | Rubber           |                | 2-Piece Rubber   |                | Type       | Rated Output   | Electrode Range            |
|--------------------------|------------------|----------------|------------------|----------------|------------|--|----------------------------|
|                          | 12.5 ft. (3.8 m) | 25 ft. (7.6 m) | 12.5 ft. (3.8 m) | 25 ft. (7.6 m) |            |  |                            |
| A-200                    | WP-26-12-R       | WP-26-25-R     | WP-26-12-2       | WP-26-25-2     | Air-cooled | DC: 200 A at 60% duty cycle<br>AC: 150 A at 60% duty cycle | .020-5/32 in. (0.5-4.0 mm) |
| A-200 Valve              | WP-26V-12-R      | WP-26V-25-R    | WP-26V-12-2      | WP-26V-25-2    |            |  |                            |
| A-200 Flex               | WP-26F-12-R      | WP-26F-25-R    | —                | WP-26F-25-2    |            |  |                            |
| A-200 Flex Valve         | WP-26FV-12-R     | WP-26FV-25-R   | WP-26FV-12-2     | WP-26FV-25-2   |            |  |                            |
| A-200 Flex Redhead       | WP-R26F-12-R     | —              | —                | —              |            |  |                            |
| A-200 Flex Valve Redhead | —                | WP-R26FV-25-R  | —                | —              |            |  |                            |

### Applications

- Fabrication ▪ Maintenance and repair
- Manufacturing ▪ Shipbuilding
- Vocational

### Most popular consumables

- Collets
  - 10N23 1/16 in. (1.6 mm)
  - 10N24 3/32 in. (2.4 mm)
  - 10N25 1/8 in. (3.2 mm)
- Collet Bodies
  - 10N31 1/16 in. (1.6 mm)
  - 10N32 3/32 in. (2.4 mm)
  - 10N28 1/8 in. (3.2 mm)
- Alumina Nozzles
  - 10N47 #7, 7/16 in.
  - 10N46 #8, 1/2 in.
  - 10N45 #10, 5/8 in.

### Most popular accessories



- **Gas Lens Kit AK3GL** (pg 67)  
Includes one short back cap, one of each size (#6, #7, #8) alumina nozzle, and one of each size (1/16, 3/32, 1/8 inch) of the following: gas lens, collet, and 7-inch 2% ceriated tungsten electrode



- **Accessory Kit AK3C** (pg 67)  
Includes one short back cap, one of each size (#5, #6, #8) alumina nozzle, and one of each size (1/16, 3/32, 1/8 inch) of the following: collet, collet body, and 7-inch 2% ceriated tungsten electrode  
Visit [MillerWelds.com](http://MillerWelds.com) or your distributor for other Miller® options and accessories.

# Weldcraft™ A-250 Series

See literature AY/24.5



**Dependable, top-performing air-cooled torches designed for heavy-duty welding applications.**

**Eliminate the expense** of a water-cooled system. The air-cooled capability of the A-250 Series pairs reliability with cost-effectiveness for all field applications.

**Robust performance.** The heavy copper construction delivers optimal welding capacity for rugged fieldwork.

**Effortless adjustments.** Gas control valve ensures quick and easy adjustment of shielding gas flow (A-250 Valve).

| Model       | 2-Piece Rubber, 25 ft. (7.6 m) | Type       | Rated Output   | Electrode Range            |
|-------------|--------------------------------|------------|--|----------------------------|
| A-250       | 301525025                      | Air-cooled | DC: 250 A at 60% duty cycle<br>AC: 188 A at 60% duty cycle | .020-5/32 in. (0.5-4.0 mm) |
| A-250 Valve | 301526025                      |            |  |                            |

# SHARE YOUR PASSION

## REVIEWS & RATINGS OFFER VALUABLE INSIGHTS TO HELP GUIDE YOUR NEXT PURCHASE.

They're written and submitted by people who have purchased and used Miller® equipment. If you'd like to share your experience and help your fellow welders select the right welding equipment consider writing a review. Simply visit the product page on the website for the product you want to write about and click on "Write a Review".

Visit now at [MillerWelds.com](http://MillerWelds.com)

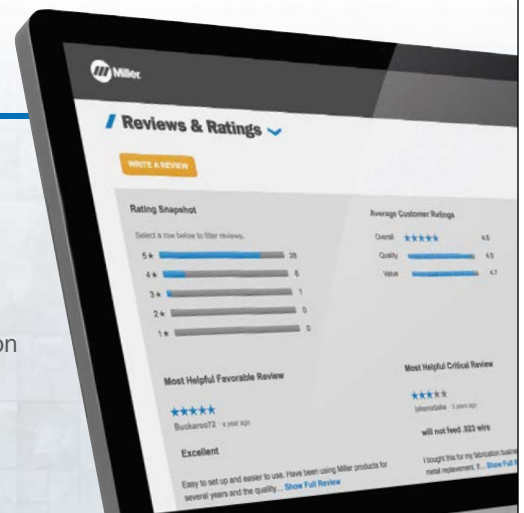

# Weldcraft™ W-180

See literature AY/26.0

Formerly known as WP-24W



**One of the smallest water-cooled TIG torches on the market and designed for welding in confined areas that require high amperage.**

**Use high amperage in confined areas** for efficient welding.

**Superior maneuverability** in limited-access locations with the compact torch body.

**Excellent weld capacity** without increasing torch size, due to the efficient cooling system.

### Applications

- Aerospace ▪ Manufacturing
- Food/beverage industry ▪ Shipbuilding
- Maintenance and repair
- Petro/chemical ▪ Precision fabrication

### Most popular consumables

- Collets
  - 53N16 .040 in. (1.0 mm)
  - 53N14 1/16 in. (1.6 mm)
  - 24C332 3/32 in. (2.4 mm)
- Collet Bodies
  - 53N18 .040 in. (1.0 mm)
  - 53N19 1/16 in. (1.6 mm)
  - 24CB332 3/32 in. (2.4 mm)
- Alumina Nozzles
  - A53N24 #4, 1/4 in.
  - A53N25 #5, 5/16 in.
  - A53N27 #6, 3/8 in.

| Model | Braided Rubber, 25 ft. (7.6 m) | Vinyl, 25 ft. (7.6 m) | Type         | Rated Output   | Electrode Range            |
|-------|--------------------------------|-----------------------|--------------|--|----------------------------|
| W-180 | WP-24W-25-R                    | WP-24W-25             | Water-cooled | DC: 180 A at 100% duty cycle, AC: 115 A at 100% duty cycle | .020-3/32 in. (0.5-2.4 mm) |

# Weldcraft™ W-200 Pencil Flex

See literature AY/27.0

Formerly known as WP-25



**Versatile water-cooled torch optimized for use in limited-access welding situations.**

**Pencil-style with flexible neck** designed for both high-amperage applications and confined-area access.

**Decreased downtime and longer trouble-free service** due to overheating with the innovative cooling design.

**Comfort and control** are increased with the lightweight, well-balanced body design.

### Applications

- Aerospace ▪ Aluminum fabrication
- Automotive ▪ Manufacturing
- Exotic material fabrication
- Precision metal fabrication
- Pressure vessel fabrication
- Shipbuilding ▪ Tool and die
- Tube and pipe ▪ Vocational

### Most popular consumables

- Insulator (non-gas lens and gas lens) (required) 598882
- Collets (non-gas lens and gas lens)
  - 13N21 .040 in. (1.0 mm)
  - 13N22 1/16 in. (1.6 mm)
  - 13N23 3/32 in. (2.4 mm)
  - 13N24 1/8 in. (3.2 mm)
- Collet Bodies
  - 13N26 .040 in. (1.0 mm)
  - 13N27 1/16 in. (1.6 mm)
  - 13N28 3/32 in. (2.4 mm)
  - 13N29 1/8 in. (3.2 mm)

| Model             | Braided Rubber 12.5 ft. (3.8 m) | 25 ft. (7.6 m) | Vinyl 12.5 ft. (3.8 m) | 25 ft. (7.6 m) | Type         | Rated Output   | Electrode Range           |
|-------------------|---------------------------------|----------------|------------------------|----------------|--------------|--|---------------------------|
| W-200 Pencil Flex | WP-25-12-R                      | WP-25-25-R     | WP-25-12               | WP-25-25       | Water-cooled | DC: 200 A at 100% duty cycle<br>AC: 140 A at 100% duty cycle | .020-1/8 in. (0.5-3.2 mm) |

# Weldcraft™ W-250 Series

See literature AY/29.0

Formerly known as WP-20 Series



**Water-cooled torches that provide consistent performance and long-term trouble-free service with around-the-head water cooling.**

**Extend torch life and minimize downtime** due to overheating with the efficient around-the-head cooling design.

**Reduce leakage** of gas and water through secure mechanical fittings and connections.

**Easy hose replacement** with the innovative mechanical fittings design (W-250 Valve).

- Gas Lens
  - 45V42 .040 in. (1.0 mm)
  - 45V43 1/16 in. (1.6 mm)
  - 45V44 3/32 in. (2.4 mm)
  - 45V45 1/8 in. (3.2 mm)
- Alumina Nozzles
  - 13N08 #4, 1/4 in.
  - 13N09 #5, 5/16 in.
  - 13N10 #6, 3/8 in.
  - 13N11 #7, 7/16 in.
  - 13N12 #8, 1/2 in.
  - 13N13 #10, 5/8 in.
  - 53N58 #4, 1/4 in. (gas lens)
  - 53N59 #5, 5/16 in. (gas lens)
  - 53N60 #6, 3/8 in. (gas lens)
  - 53N61 #7, 7/16 in. (gas lens)
  - 53N61S #8, 1/2 in. (gas lens)

### Most popular accessories



- Cable Covers
  - WC-3-10 10 ft. (3 m)
  - WC-3-22 22 ft. (6.7 m)

Visit [MillerWelds.com](http://MillerWelds.com) or your distributor for other Miller® options and accessories.

| Model       | Braided Rubber 12.5 ft. (3.8 m) | 25 ft. (7.6 m) | Vinyl 12.5 ft. (3.8 m) | 25 ft. (7.6 m) | Type         | Rated Output   | Electrode Range           |
|-------------|---------------------------------|----------------|------------------------|----------------|--------------|--|---------------------------|
| W-250       | WP-20-12-R                      | WP-20-25-R     | WP-20-12               | WP-20-25       | Water-cooled | DC: 250 A at 100% duty cycle<br>AC: 180 A at 100% duty cycle | .020-1/8 in. (0.5-3.2 mm) |
| W-250 Valve | -                               | -              | -                      | WP-20V-25      |              |  |                           |

# Weldcraft™ W-280 Super Cool™

Formerly known as WP-280

See literature AY/30.0



**Reliable water-cooled torch designed for demanding, high-amperage applications.**

**Super Cool technology** provides additional surface area to increase cooling efficiency and capacity.

**Reduce downtime** due to overheating through consistent water-cooled performance.

**Reduce leakage** of gas and water through secure mechanical fittings and connections.

| Model            | Braided Rubber<br>12.5 ft. (3.8 m) |           | Braided Rubber with 50 mm Dinse<br>25 ft. (7.6 m) | Type         | Rated Output   | Electrode Range              |
|------------------|------------------------------------|-----------|---|--------------|--|------------------------------|
|                  | 25 ft. (7.6 m)                     | 301251025 |   |              |  |                              |
| W-280 Super Cool | 301251012                          | 301251025 | 301251001   | Water-cooled | DC: 280 A at 100% duty cycle<br>AC: 195 A at 100% duty cycle | .020-1/8 in.<br>(0.5-3.2 mm) |

### Applications

- Aerospace ▪ Aluminum fabrication
- Automotive ▪ Manufacturing
- Exotic material fabrication
- Precision metal fabrication
- Pressure vessel fabrication
- Shipbuilding ▪ Tool and die
- Tube and pipe ▪ Vocational

### Most popular consumables

- Insulator (non-gas lens and gas lens) (required) 598882
- Collets (non-gas lens and gas lens)
  - 13N21 .040 in. (1.0 mm)
  - 13N22 1/16 in. (1.6 mm)
  - 13N23 3/32 in. (2.4 mm)
  - 13N24 1/8 in. (3.2 mm)
- Collet Bodies
  - 13N26 .040 in. (1.0 mm)
  - 13N27 1/16 in. (1.6 mm)
  - 13N28 3/32 in. (2.4 mm)
  - 13N29 1/8 in. (3.2 mm)
- Gas Lens
  - 45V42 .040 in. (1.0 mm)
  - 45V43 1/16 in. (1.6 mm)
  - 45V44 3/32 in. (2.4 mm)
  - 45V45 1/8 in. (3.2 mm)
- Alumina Nozzles
  - 13N08 #4, 1/4 in.
  - 13N09 #5, 5/16 in.
  - 13N10 #6, 3/8 in.
  - 13N11 #7, 7/16 in.
  - 13N12 #8, 1/2 in.
  - 13N13 #10, 5/8 in.
  - 53N58 #4, 1/4 in. (gas lens)
  - 53N59 #5, 5/16 in. (gas lens)
  - 53N60 #6, 3/8 in. (gas lens)
  - 53N61 #7, 7/16 in. (gas lens)
  - 53N61S #8, 1/2 in. (gas lens)
- Back Caps
  - 41V33 Short
  - 41V35 Medium
  - 41V24 Long

# Weldcraft™ W-375 Super Cool™

See literature AY/32.5



**Reliable water-cooled torch designed for demanding, high-amperage applications.**

**Super Cool technology** provides additional surface area to increase cooling efficiency and capacity.

**Reduce downtime** due to overheating through consistent water-cooled performance.

**Reduce leakage** of gas and water through secure mechanical fittings and connections.

| Model            | Braided Rubber<br>12.5 ft. (3.8 m) |           | Braided Rubber with 50 mm Dinse<br>25 ft. (7.6 m) | Type         | Rated Output   | Electrode Range              |
|------------------|------------------------------------|-----------|---|--------------|--|------------------------------|
|                  | 25 ft. (7.6 m)                     | 301253025 |   |              |  |                              |
| W-375 Super Cool | 301253012                          | 301253025 | 301253001   | Water-cooled | DC: 375 A at 100% duty cycle<br>AC: 265 A at 100% duty cycle | .020-1/8 in.<br>(0.5-3.2 mm) |

### Most popular accessories

- Cable Covers
  - WC0183 11.75 ft. (3.6 m)
  - WC0182 24.25 ft. (7.4 m)

Visit [MillerWelds.com](http://MillerWelds.com) or your distributor for other Miller® options and accessories.

# Weldcraft™ W-350 Series

Formerly known as WP-18 Series

See literature AY/32.0



**Rugged water-cooled torches engineered for high-amperage and continuous hand-held welding in mechanized applications.**

**Reduce downtime and costs** by minimizing overheating with the unique cooling design engineered for operator comfort.

**Reduce discomfort and fatigue** using the comfortable handle design.

**Superior gas flow control** offered through the built-in fingertip gas control (W-350 Valve).

### Applications

- Fabrication ▪ Manufacturing
- Maintenance and repair
- Shipbuilding ▪ Tube and pipe

### Most popular consumables

- Collets
  - 10N24 3/32 in. (2.4 mm)
  - 10N25 1/8 in. (3.2 mm)
  - 54N20 5/32 in. (4.0 mm)
- Collet Bodies
  - 10N32 3/32 in. (2.4 mm)
  - 10N28 1/8 in. (3.2 mm)
  - 406488 5/32 in. (4.0 mm)
- Alumina Nozzles
  - 10N48 #6, 3/8 in.
  - 10N47 #7, 7/16 in.
  - 10N46 #8, 1/2 in.
  - 10N45 #10, 5/8 in.
  - 10N44 #12, 3/4 in.

| Model       | Rubber<br>12.5 ft. (3.8 m) |             | Vinyl<br>12.5 ft. (3.8 m) |           | Type         | Rated Output   | Electrode Range            |
|-------------|----------------------------|-------------|---------------------------|-----------|--------------|--|----------------------------|
|             | 25 ft. (7.6 m)             | WP-18-25-R  | WP-18-12                  | WP-18-25  |              |  |                            |
| W-350       | WP-18-12-R                 | WP-18-25-R  | WP-18-12                  | WP-18-25  | Water-cooled | DC: 350 A at 100% duty cycle<br>AC: 250 A at 100% duty cycle | .020-5/32 in. (0.5-4.0 mm) |
| W-350 Valve | —                          | WP-18V-25-R | —                         | WP-18V-25 |              |  |                            |

# Weldcraft™ W-400 Super Cool™

See literature AY/33.0

Formerly known as WP-18SC



**Water-cooled torch designed to endure some of the most demanding applications while minimizing overheating.**

**Extend torch and consumable life** with the full-flow water chamber that provides around-the-head cooling.

**Improve gas coverage and cooling capacity** with gas lens usage with heavy-duty stubby collet body.

**Extend parts life** using the durable copper components, maximizing current capacity.

**Applications**

- Heavy fabrication
- Tool and die
- Pipe and tube fabrication
- Pressure vessel fabrication

**Most popular consumables**

- Heavy-Duty Collets
  - 10N25HD 1/8 in. (3.2 mm)
  - 54N20HD 5/32 in. (4.0 mm)
  - 18C36 3/16 in. (4.8 mm)
- Heavy-Duty Nose Collet Body (all sizes) NCB-36
- Alumina Nozzles
  - 54N16 #6, 3/8 in.
  - 54N15 #7, 7/16 in.
  - 54N14 #8, 1/2 in.
- Back Caps
  - 57Y04 Short
  - 300M Medium

| Model            | Rubber, 25 ft. (7.6 m) | Vinyl, 25 ft. (7.6 m) | Type         | Rated Output   | Electrode Range            |
|------------------|------------------------|-----------------------|--------------|--|----------------------------|
| W-400 Super Cool | WP-18SC-25-R           | WP-18SC-25            | Water-cooled | DC: 400 A at 100% duty cycle, AC: 280 A at 100% duty cycle | .020-3/16 in. (0.5-4.8 mm) |

# Weldcraft™ Modular Series

See literature AY/36.0



**Air-cooled and water-cooled torches engineered to weld multiple joint configurations for various applications and angles.**

**Built-in, efficient cooling system** reduces overheating to extend parts and consumable life.

**Modular design** minimizes costs and downtime for torch changeover and parts inventory.

**Easy configurable head options** provide greater flexibility and joint access, minimizing downtime for torch changeover.

**Gas valve** provides greater shielding gas flow control (A-150 Modular Valve).

**Applications**

- Maintenance and repair
- Aerospace
- Metal art
- Food/beverage industry
- Petro/chemical
- Shipbuilding
- Manufacturing
- Vocational
- Precision fabrication
- Tube and pipe

**Most popular accessories**



- **Accessory Kit** (pg 67)
  - AK-150MFC For A-150 torch
  - AK-225MFC For W-225 torch

| Model               | Rubber 12.5 ft. (3.8 m)         | 25 ft. (7.6 m) | Type                 | Rated Output (Torch head dependent)                        | Electrode Range (Torch head dependent)                       |  |
|---------------------|---------------------------------|----------------|----------------------|--|--|--|
| A-150 Modular       | WP-150-12-R                     | WP-150-25-R    | Air-cooled           | DC: 150 A at 60% duty cycle<br>AC: 105 A at 60% duty cycle | .020-1/8 in. (0.5-3.2 mm)                                    |  |
| A-150 Modular Valve | WP-150V-12-R                    | WP-150V-25-R   |                      |  |  |  |
| Model               | Braided Rubber 12.5 ft. (3.8 m) | 25 ft. (7.6 m) | Vinyl 25 ft. (7.6 m) | Type   | Rated Output (Torch head dependent)                          | Electrode Range (Torch head dependent) |
| W-225 Modular       | WP-225-12-R                     | WP-225-25-R    | WP-225-25            | Water-cooled   | DC: 225 A at 100% duty cycle<br>AC: 160 A at 100% duty cycle | .020-5/32 in. (0.5-4.0 mm)             |

# Weldcraft™ W-125 Long Micro

See literature AY/25.0

Formerly known as WP-125L



**Water-cooled MicroTig® torch designed for limited-access joints.**

**Small 5-inch torch body** designed for limited-access joints.

**Low-profile nozzle** fits into holes as small as 5/8-inch diameter.

**45-degree, 90-degree, and 180-degree options** improve access in tight areas.

**Lower maintenance costs** incurred with the replaceable silicone rubber insulator and head components.

**Applications**

- Aerospace
- Food/beverage industry
- HVAC
- Automotive
- Petro/chemical
- Precision fabrication

**Most popular consumables**

- 90° Chucks
  - 125C40-90 .040 in. (1.0 mm)
  - 125C116-90 1/16 in. (1.6 mm)
  - 125C332-90 3/32 in. (2.4 mm)
- 90° Quartz Nozzle (all sizes)
  - 125N90Q (other nozzles are available)



| Model            | Braided Rubber, 25 ft. (7.6 m) | Type         | Rated Output  | Electrode Range            |
|------------------|--------------------------------|--------------|---|----------------------------|
| W-125 Long Micro | WP-125L-25-R                   | Water-cooled | DC: 125 A at 100% duty cycle<br>AC: 80 A at 100% duty cycle | .040-3/32 in. (1.0-2.4 mm) |

# Weldcraft™ Automation Series

See literature AY/37.0



**Air-cooled and water-cooled torches designed for high- and low-amperage mechanized applications.**

**Minimize downtime** associated with tungsten changeover by using the front or back tungsten loading areas.

**Built-in gas lens** improves gas coverage to minimize shielding gas turbulence and improve weld quality (W-500A Automation and W-500B Automation).

**Handle the most demanding high-amperage applications** (W-500 Automation).

**Applications**

- Aerospace
- Food/beverage industry
- Pressure vessel fabrication
- Petro/chemical

**Most popular accessories**

▪ **Cable Covers**

- WC-3-10 10 ft. (3 m)
- WC-3-22 22 ft. (6.7 m)
- WC-4-10 10 ft. (3 m)
- WC-4-22 22 ft. (6.7 m)



▪ **Air-Cooled Torch 1-Piece Power Cable Connector** (pg 125)

- 195378 50 mm Dinse-style



▪ **Water-Cooled Torch 1-Piece Power Cable Connectors** (pg 125)

- 195377 50 mm Dinse-style
- 225028 50 mm thread-lock

Visit [MillerWelds.com](http://MillerWelds.com) or your distributor for other Miller® options and accessories.

| Model             | Rubber, 12.5 ft. (3.8 m) |                  | 2-Piece Rubber, 12.5 ft. (3.8 m) |                  |                | Type         | Rated Output   | Electrode Range               |
|-------------------|--------------------------|------------------|----------------------------------|------------------|----------------|--------------|--|-------------------------------|
| A-150 Automation  | WP-23A-12-R              |                  | WP-23A-12-2                      |                  |                | Air-cooled   | DC: 150 A at 60% duty cycle<br>AC: 120 A at 60% duty cycle   | .040-3/32 in.<br>(1.0-2.4 mm) |
| Model             | Rubber<br>3 ft. (0.9 m)  | 12.5 ft. (3.8 m) | Vinyl<br>3 ft. (0.9 m)           | 12.5 ft. (3.8 m) | 25 ft. (7.6 m) | Type         | Rated Output   | Electrode Range               |
| W-250 Automation  | —                        | —                | WP-22A-3                         | WP-22A-12        | WP-22A-25      | Water-cooled | DC: 250 A at 100% duty cycle<br>AC: 180 A at 100% duty cycle | .040-1/8 in.<br>(1.0-3.2 mm)  |
| W-500A Automation | WP-27A-3                 | WP-27A-12        | —                                | —                | —              | Water-cooled | DC: 500 A at 100% duty cycle<br>AC: 350 A at 100% duty cycle | .040-1/4 in.<br>(1.0-6.4 mm)  |
| W-500B Automation | WP-27B-3                 | WP-27B-12        | —                                | —                | —              | Water-cooled | DC: 500 A at 100% duty cycle<br>AC: 350 A at 100% duty cycle | .040-1/4 in.<br>(1.0-6.4 mm)  |

# Weldcraft™ Tungsten

**Tungsten for the most demanding TIG welding applications!**

Available in four types and industry-standard diameters, our line of Weldcraft tungsten electrodes has undergone rigorous testing to ensure the highest quality and durability. Color-coded packages include ten 7-inch (175 mm) tungsten electrodes.

| Type   | Stock Number | Diameter in. (mm) | Type   | Stock Number | Diameter in. (mm) |
|--|--------------|-------------------|--|--------------|-------------------|
| <b>2% Ceriated (EWCe-2)</b>  |              |                   | <b>Pure (EWP)</b>  |              |                   |
| Performs well in DC welding and arc starting at low-current settings. Offers excellent performance in AC processes.                        | WC040X7      | 0.040 (1.0)       | Forms a clean, balled end when heated. Provides good arc stability for AC welding with a balanced or unbalanced squarewave or sine wave. | —            | 0.040 (1.0)       |
|  | WC116X7      | 1/16 (1.6)        |  | WP116X7      | 1/16 (1.6)        |
|  | WC332X7      | 3/32 (2.4)        |  | WP332X7      | 3/32 (2.4)        |
|  | WC018X7      | 1/8 (3.2)         |  | WP018X7      | 1/8 (3.2)         |
|  | WC532X7      | 5/32 (4.0)        |  | —            | 5/32 (4.0)        |
| <b>2% Lanthanated (EWLa-2)</b>   |              |                   | <b>Rare Earth (EWG)</b>  |              |                   |
| Provides excellent arc starting, arc stability and re-ignition, and less tip erosion in AC or DC welding. Can substitute for 2% Thoriated. | WL2040X7     | 0.040 (1.0)       | Combines the best of all alloying elements, and provides excellent arc stability in AC or DC welding.                                    | —            | 0.040 (1.0)       |
|  | WL2116X7     | 1/16 (1.6)        |  | WG116X7      | 1/16 (1.6)        |
|  | WL2332X7     | 3/32 (2.4)        |  | WG332X7      | 3/32 (2.4)        |
|  | WL2018X7     | 1/8 (3.2)         |  | WG018X7      | 1/8 (3.2)         |
|  | WL2532X7     | 5/32 (4.0)        |  | —            | 5/32 (4.0)        |



Note: Refer to manufacturer SDS sheets for proper preparation and safety. Use proper ventilation/capture during preparation. Refer to manufacturer warning regarding ventilation.

# Weldcraft™ TIG Torch Accessories

## GL Kits (Gas Lens Kits)

Gas lenses improve the gas coverage of the tungsten during the TIG welding process. They can save you time and money by increasing your weld quality while using less gas. GL kits provide three different-sized gas lenses and consumables in each kit to work with a variety of different applications.



**AK3GL**  
For A-150, A-200 and A-250. Includes one short back cap, one of each size (#6, #7, #8) alumina nozzle, and one of each size (1/16, 3/32, 1/8 inch) of the following: gas lens, collet, and 7-inch 2% ceriated tungsten electrode.

size (1/16, 3/32, 1/8 inch) of the following: gas lens, collet, and 7-inch 2% ceriated tungsten electrode.



**AK4GL**  
For W-200, W-225, W-250, W-280 Super Cool and W-375 Super Cool. Includes one short back cap, one of each size (#6, #7, #8) alumina nozzle, and one of each size (1/16, 3/32, 1/8 inch) of the following: gas lens, collet, and 7-inch 2% ceriated tungsten electrode.

size (#6, #7, #8) alumina nozzle, and one of each size (1/16, 3/32, 1/8 inch) of the following: gas lens, collet, and 7-inch 2% ceriated tungsten electrode.

## AK Kits (Accessory Kits)

AK kits provide a set of different consumables for Weldcraft torches to tackle a variety of different applications. Kits include nozzles, collets, collet bodies, tungsten and back caps.



**AK1C**  
For A-125 Series. Includes one long back cap, one of each size (#4, #5, #6) alumina nozzle, and one of each size (.040, 1/16 inch) of the following: collet, collet body, and 7-inch 2% ceriated tungsten electrode.

one of each size (.040, 1/16 inch) of the following: collet, collet body, and 7-inch 2% ceriated tungsten electrode.



**AK2C**  
For A-150 Series. Includes one short back cap, one of each size (#4, #5, #6) alumina nozzle, and one of each size (.040, 1/16, 3/32 inch) of the following: collet, collet body, and 7-inch 2% ceriated tungsten electrode.

size (.040, 1/16, 3/32 inch) of the following: collet, collet body, and 7-inch 2% ceriated tungsten electrode.



**AK3C**  
For A-200 Series, A-250 Series and W-350 Series. Includes one short back cap, one of each size (#5, #6, #8) alumina nozzle, and one of each size (1/16, 3/32, 1/8 inch) of the following: collet, collet body, and 7-inch 2% ceriated tungsten electrode.

(#5, #6, #8) alumina nozzle, and one of each size (1/16, 3/32, 1/8 inch) of the following: collet, collet body, and 7-inch 2% ceriated tungsten electrode.



**AK4C**  
For W-250 Series, W-280 Super Cool and W-375 Super Cool. Includes one long back cap, one of each size (#5, #6, #7) alumina nozzle, and one of each size (1/16, 3/32, 1/8 inch) of the following: collet, collet body, and 7-inch 2% ceriated tungsten electrode.

one of each size (#5, #6, #7) alumina nozzle, and one of each size (1/16, 3/32, 1/8 inch) of the following: collet, collet body, and 7-inch 2% ceriated tungsten electrode.



**AK18C**  
For W-400 Super Cool. Includes one short back cap, one of each size (#6, #7, #8) alumina nozzle, one of each size (3/32, 1/8 HD, 5/32 HD) nozzle, one of each size (.020-1/8 inch, 1/8-3/16 inch) collet body, and one of each size (3/32, 1/8, 5/32 inch) 7-inch 2% ceriated tungsten electrode.

collet, one of each size (.020-1/8 inch, 1/8-3/16 inch) collet body, and one of each size (3/32, 1/8, 5/32 inch) 7-inch 2% ceriated tungsten electrode.



**AK125C**  
For W-125 Long Micro. Includes one of each size (180°, 45°, 90°, 90° short) glass nozzle, and one of each size (.040, 1/16 inch) of the following: 180-degree chuck, 45-degree chuck, 90-degree chuck, and 7-inch 2% ceriated tungsten electrode.

nozzle, and one of each size (.040, 1/16 inch) of the following: 180-degree chuck, 45-degree chuck, 90-degree chuck, and 7-inch 2% ceriated tungsten electrode.



**AK-150MFC**  
For A-125 Series, A-150 Series and A-150 Modular Series. Allows welding operators to customize their standard A-125 (WP-9) or A-150 (WP-17) TIG torch for their specific application. Kit converts into 28 different torch styles while using the A-125 and A-150 existing cable. Features collets, collet bodies, nozzles, torch heads, handle and more.

application. Kit converts into 28 different torch styles while using the A-125 and A-150 existing cable. Features collets, collet bodies, nozzles, torch heads, handle and more.



**AK-225MFC**  
For W-225 Modular. Includes five additional torch heads, collets, collet bodies, nozzles, handle and more.

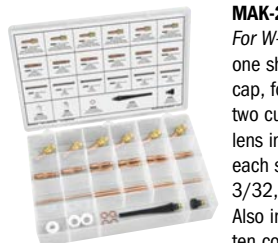

**MAK-2S**  
For W-350 Series. Includes one short and one long back cap, four back cap o-rings, two cup gaskets, one gas lens insulator, and one of each size (.040, 1/16, 3/32, 1/8 inch) gas lens. Also includes the following ten collets: (1) .040, (3) 1/16, (3) 3/32, (2) 1/8, (1) 5/32; and eight collet bodies: (1) .040, (2) 1/16, (2) 3/32, (2) 1/8, (1) 5/32.

Also includes the following ten collets: (1) .040, (3) 1/16, (3) 3/32, (2) 1/8, (1) 5/32; and eight collet bodies: (1) .040, (2) 1/16, (2) 3/32, (2) 1/8, (1) 5/32.

## Quick Connects



**QRG**  
Allows for quick connection and removal of torch shielding gas hoses.



**QRW**  
Allows for quick connection and removal of torch coolant hoses.

## Cable Covers



**WC-3-10** 10 ft. (3 m)  
**WC-3-22** 22 ft. (6.7 m)  
**WC-3-48** 48 ft. (14.6 m)  
Cable covers protect the welding cables from the day-to-day wear and tear of common welding environments. Available in 10-foot, 22-foot, and 48-foot lengths, these covers can help prevent the frequent replacement of expensive welding cables.

environments. Available in 10-foot, 22-foot, and 48-foot lengths, these covers can help prevent the frequent replacement of expensive welding cables.

## Remote Controls

See pages 124-125 in Accessories section for stock numbers and more information.



East/west rotary-motion fingertip current/contacter controls.



North/south rotary-motion fingertip current/contacter controls.



Foot pedal current/contacter controls.



Miniature hand current/contacter controls.



Momentary- and maintained-contact rocker switch for contactor control.



Momentary-contact switch for contactor controls.



Remote on/off control.

# Engineered for simplicity. Built for durability.

Your welders select the Bernard gun handles, triggers and necks that are **the most comfortable and effective** for accessing their welds.

Management enjoys the resulting **increase in productivity, longer gun life, and a reduced parts inventory** with consumables designed to work across all of your welding guns.

For more information see pages 25–26, or contact your local welding distributor or Bernard directly.

**BERNARD**<sup>®</sup>



Visit the **NEW! merged website** for **Bernard and Tregaskiss** at **Tregaskiss.com**

**1-855-MIGWELD (644-9353)**



## Maximizing throughput. Minimizing costs.

Automated welding applications require flexible, repeatable solutions that **maximize production uptime and throughput while minimizing costs**. This is why industrial manufacturers rely on Tregaskiss and its proven track record of delivering **reliable and resilient robotic and fixed automatic MIG welding guns, peripherals and consumables**.

For more information see pages 34–35, or contact your local welding distributor or Tregaskiss directly.

 **Tregaskiss**<sup>®</sup>



For more detailed information, visit

MillerWelds.com/insight

# Welding Intelligence™



Insight Welding Intelligence™: The Total Welding Data Solution

With an Insight weld monitoring system you can get more done, produce higher-quality welds and control costs.



# Insight

WELDING INTELLIGENCE™  
Core | Centerpoint

Complete coverage for any application.



Manufacturing



Automation



Submerged arc

## Choose the Right Welding Intelligence System

|                                     |                                  | <b>Insight Core™</b>   | <b>Insight Centerpoint™</b>  | <b>Insight ArcAgent™</b>  |
|-------------------------------------|----------------------------------|--|--|---|
| <b>For Use With</b>                 | <b>Factory-Installed</b>         | <ul style="list-style-type: none"> <li>Continuum™/Auto-Continuum™ (standard)</li> <li>Deltaweld® (optional)</li> </ul>                                       | <ul style="list-style-type: none"> <li>Continuum™/Auto-Continuum™ (optional)</li> </ul>  | <ul style="list-style-type: none"> <li>ANY welding power source (old or new)</li> <li>ANY brand</li> <li>ANY welding process</li> </ul> |
|                                     | <b>Field-Installed/Activated</b> | <ul style="list-style-type: none"> <li>14-pin compliant power source (see MillerWelds.com/insight)</li> </ul>  | <ul style="list-style-type: none"> <li>Continuum™/Auto-Continuum™</li> </ul>   |   |
| <b>Requirements</b>                 |                                  | <ul style="list-style-type: none"> <li>Internet connection (wired/wireless)</li> </ul>   | <ul style="list-style-type: none"> <li>PC and Ethernet connection</li> </ul>   | <ul style="list-style-type: none"> <li>See Insight ArcAgent literature WI/1.0</li> </ul>  |
| <b>What Capability Do You Need?</b> |                                  | <ul style="list-style-type: none"> <li>Productivity monitoring</li> <li>Weld parameter verification</li> <li>Goal setting</li> <li>Analytic tools</li> </ul> | <ul style="list-style-type: none"> <li>Ensure quality welds</li> <li>Reduce missed welds</li> <li>Minimize overwelding/underwelding</li> <li>Electronic work instructions</li> </ul> | <ul style="list-style-type: none"> <li>Universal solution for use with Insight Core or Insight Centerpoint</li> </ul>                   |
| <b>Data Storage</b>                 |                                  | <ul style="list-style-type: none"> <li>Cloud based</li> </ul>  | <ul style="list-style-type: none"> <li>Local server or PC</li> </ul>   | <ul style="list-style-type: none"> <li>See Insight ArcAgent literature WI/1.0</li> </ul>  |

# Insight Core™

Reports welding productivity from a web-based application to measure and improve your operation.

## Helps you answer

- Who is your most productive operator?
- What is your most productive welder, station, cell?
- Are your quality risks increasing or decreasing?
- What are your true welding costs?



## Software features

### Measures productivity.

See each welder's arc-on time to set baselines, plan improvements and measure goals.

**Reports.** Easy-to-understand dashboards show trends and develop reports. Compare welders, cells and plants.

### Easily install and use.

Just connect it to the internet. View secure data on any web-connected device anywhere.

**Analytics tools.** Business analytic tools allowing for weld data analysis based on individual/cell performance as well as overall financial terms.

**Notifications.** Email/text notifications based on your desired frequency and subject.

### Multiple languages available.

English, German, Spanish, French, Italian, Dutch, Portuguese and Chinese.

## How it works

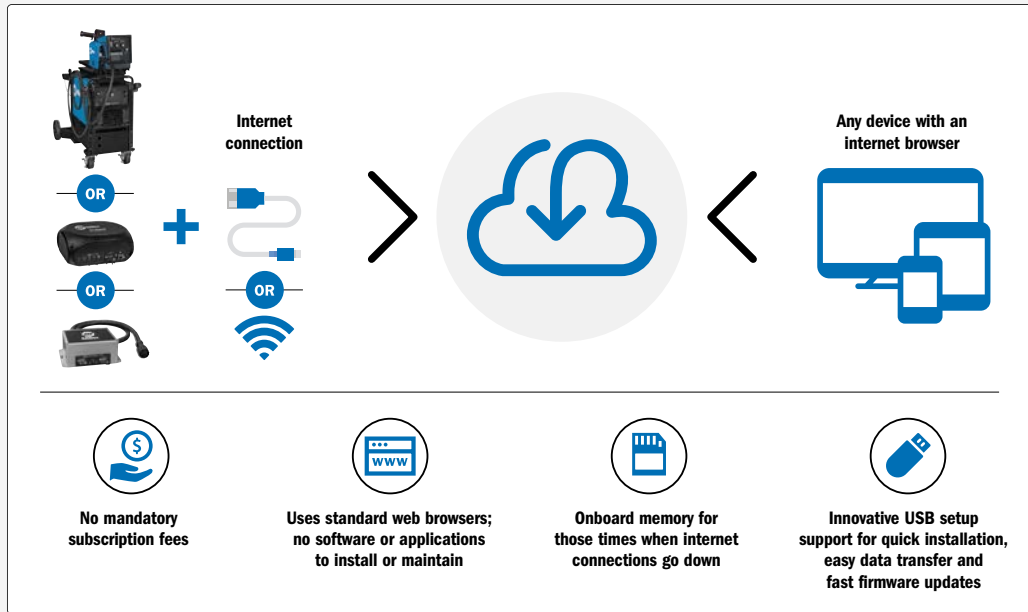

## Universal brand capability

With an ArcAgent™ module, customers can have the power of Insight Core on any machine from any manufacturer.

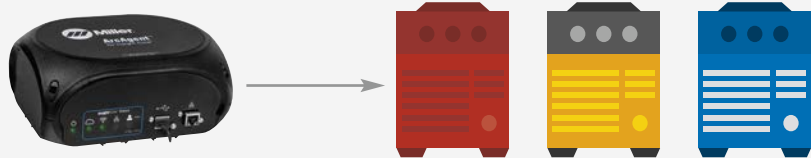

For more information: Email [insight@MillerWelds.com](mailto:insight@MillerWelds.com)

<sup>1</sup> Additional stock numbers are available – visit [MillerWelds.com/insight](http://MillerWelds.com/insight).

<sup>2</sup> TIG applications require TIG Filter (301359) to monitor voltage.

<sup>3</sup> SubArc Digital Series requires Insight Core to SubArc Digital Series Adapter Kit (301295).

| Type                           | Power Sources <sup>1</sup>   | Universal Adaptability (works with ALL brands/models of power sources)                                  | Miller 14-Pin Compliant Power Sources   |
|--------------------------------|--|---|---|
| Factory-Installed Insight Core | Deltaweld® 350 (907747002) 208/230/460 V<br>Deltaweld® 500 (907785002) 208/230/460 V<br>Deltaweld® 500 (907786002) 575 V<br>Continuum™ 350 (907636) 230-575 V<br>Continuum™ 500 (907640) 230-575 V<br>Auto-Continuum™ 350 (907656) 230-575 V<br>Auto-Continuum™ 500 (907657) 230-575 V | –   | –   |
| Field-Installed Insight Core   | –  | Requires ArcAgent for Insight Core (951773) with Stud output<br>(951851) with Dinse output <sup>2</sup> | Requires Insight Core 14-pin module (301072) <sup>3</sup><br>See <a href="http://MillerWelds.com/insight">MillerWelds.com/insight</a> for a list of 14-pin compatible power sources |

## Insight Centerpoint™

Real-time welder feedback that provides guidance and control within the weld cell, ensuring consistent quality.

### Helps you

- Present welders with step-by-step work instructions
- Identify the impact of non-welding activities
- Eliminate missing or poor welds
- Identify the true cost of a welded component

### Version 10

- Designed for ease of use
- Faster start up time
- Drastically shortened learning curve



### Software features

**Reduce training time.** Part Tracking™ guides welders through the weld sequence in real time, using visualizations of the part.

**Ensure quality welds.** Contain weld defects early and control your weld operation by monitoring every parameter of every weld.

**Reduce costs.** Alert welders if a weld is missed or is outside of acceptable parameters, allowing it to be corrected cost-effectively.

**WorkFlow™.** Gain additional control with documentation through embedded videos, images, audio and other file types.

### How it works

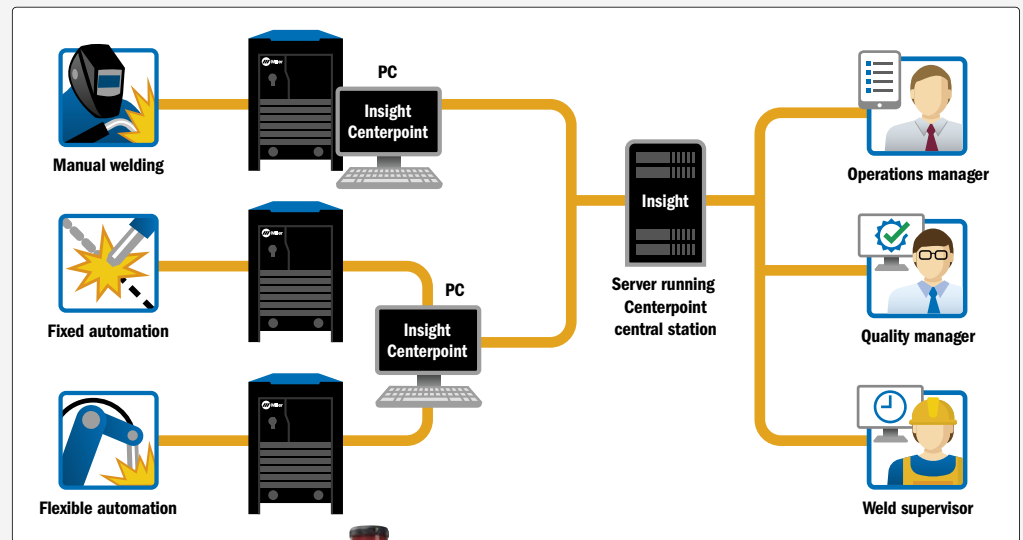

### Universal brand capability

With an ArcAgent™ module, customers can have the power of Insight Centerpoint on any machine from any manufacturer.

For more information: Email [insight@MillerWelds.com](mailto:insight@MillerWelds.com)

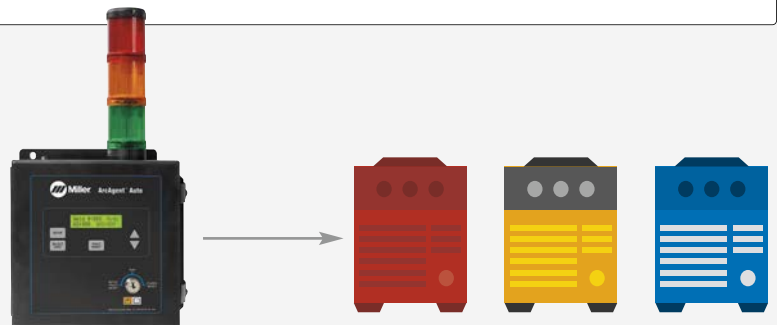

<sup>1</sup> Additional stock numbers are available – visit [MillerWelds.com/insight](http://MillerWelds.com/insight).

| Type   | Power Sources <sup>1</sup>   | Universal Adaptability<br>(works with ALL brands/models of power sources)                          | Insight Centerpoint Software | Accessories   |
|--|--|--|------------------------------|---|
| Optional<br>Factory-Installed<br>Insight Centerpoint | Continuum™ 350 (907636) 230-575 V<br>Continuum™ 500 (907640) 230-575 V<br>Auto-Continuum™ 350 (907656) 230-575 V<br>Auto-Continuum™ 500 (907657) 230-575 V | –  | (951809)                     | Insight LTD Gun (Q4015J3EML) For Continuum<br>Insight LTD Remote (301383)<br>M12/RJ45 Ethernet Cables<br>(300734) 9.8 ft. (3 m)<br>(300736) 32.8 ft. (10 m) |
| Field-Installed<br>Insight Centerpoint               | –  | Requires ArcAgent Manual or Auto<br>(301345) Manual with Insight torch capability<br>(301346) Auto | (301485)                     | Field Application Support (195480) Miller field support<br>(contact distributor for details)  |



# Engine-Driven

For more detailed information, visit



MillerWelds.com/engine-driven



## Product Guide

|                      | Page                        | Class | Stick | MIG | Flux-cored* | AC TIG | DC TIG | PAC** | CAC-A | Portability                                     | Weldable Metals            | Continuous Generator Pwr. (watts) | Welding Amperage Range            | Engine Brand   | Special Features  | Typical Applications                                      |
|----------------------|-----------------------------|-------|-------|-----|-------------|--------|--------|-------|-------|---|----------------------------|-----------------------------------|-----------------------------------|--|---|---|
| Gasoline             | Fusion 160                  | 73    | ●     | ●   |             |        |        | ●     |       | Optional lift eye or running gear               | Steel                      | 6,200                             | 30-160 DC                         | Kohler   | Portable, PowerShift technology, inverter stick   | Maintenance, construction, repair, service trucks,        |
|                      | Blue Star® 185              | 73    | ●     | ●   |             |        |        | ●     | ●     |   | Steel                      |                                   | 60-195 DC                         | Kohler   | Compact   |   |
|                      | Bobcat™ 200 Air Pak™        | 75    | ●     | ●   | ●           | ●      | ●      | ●     | ●     | Lift eye, optional running gear or trailer      | Steel, stainless aluminum  | 6,500                             | 30-210 DC                         | Kohler   | Air compressor, battery charge/crank assist, Auto-Speed™ inverter CC/CV   | Service trucks, repair, maintenance, farm/ranch           |
|                      | Bobcat™ 225                 | 76    | ●     | ●   | ●           | ●      | ●      | ●     | ●     |   | Steel, stainless aluminum  | 9,500                             | 60-160 AC<br>40-225 DC            | Kohler   | Remote start/stop, cost-effective AC/DC stick   | Maintenance, farm/ranch, construction                     |
|                      | Bobcat™ 3 Phase             | 76    | ●     | ●   | ●           | ●      | ●      | ●     | ●     |   | Steel, stainless aluminum  | 3-ph: 10,000<br>1-ph: 9,500       | 40-225 AC<br>40-210 DC            | Kohler   | 3-phase power for pivot irrigation  | Farm/ranch  |
|                      | Trailblazer® 302 Air Pak™   | 81    | ●     | ●   | ●           | ●      | ●      | ●     | ●     | 3/16"   |                            | Steel, stainless aluminum         | 11,000                            | 10-225 AC<br>10-350 DC   | Kohler  | AC/DC, CC/CV, air compressor, battery charge/crank assist |
| Gas or LP            | Bobcat™ 260                 | 76    | ●     | ●   | ●           | ●      | ●      | ●     | 3/16" | Lift eye, optional running gear or trailer      | Steel, stainless, aluminum | 9,500                             | 40-260 DC                         | Kohler   | Most popular engine drive, remote start/stop on gas models, AC/DC; optional EFI   | Fab, maintenance, farm/ranch, construction                |
|                      | Trailblazer® 325            | 78    | ●     | ●   | ●           | ●      | ●      | ●     | 3/16" |   | Steel, stainless           | 10,500 (Gas)<br>10,000 (LP)       | 10-325 DC (Gas)<br>10-305 DC (LP) | Kohler   | ArcReach®, Auto-Speed™; optional wireless interface control, EFI, Excel™ power, battery charge/crank assist                                     | Fab, maintenance, structural, repair, pipe                |
| Diesel               | Bobcat™ 200 Air Pak™ Diesel | 75    | ●     | ●   | ●           | ●      | ●      | ●     |       | Lift eye, optional running gear or trailer      | Steel, stainless, aluminum | 6,500                             | 30-210 DC                         | Kubota   | Air compressor, battery charge/crank assist, Auto-Speed™ inverter CC/CV   | Service trucks, repair, maintenance, farm/ranch           |
|                      | Bobcat™ 260 Diesel          | 76    | ●     | ●   | ●           | ●      | ●      | ●     | 3/16" |   | Steel, stainless, aluminum | 9,500                             | 40-260 DC                         | Kubota   | Contractor's choice, remote start/stop, AC/DC stick, strong FCAW  | Fab, maintenance, farm/ranch, construction                |
|                      | Trailblazer® 325 Diesel     | 78    | ●     | ●   | ●           | ●      | ●      | ●     | 3/16" |   | Steel, stainless           | 10,500                            | 10-325 DC                         | Kubota   | ArcReach®, Auto-Speed™; optional wireless interface control, Excel™ power   | Fab, maintenance, structural, repair, pipe                |
|                      | Big Blue® 400 Pro           | 81    | ●     | ●   | ●           | ●      | ●      | ●     | 3/16" | Lift eye, optional trailer                      | Steel, stainless           | 10,000                            | 20-400 DC                         | CAT, Kubota, Mitsubishi  | Quiet, compact, fuel efficient; optional wireless interface control, ArcReach®  | Construction, repair                                      |
|                      | Big Blue® 400 PipePro®      | 82    | ●     | ●   | ●           | ●      | ●      | ●     | 1/4"  |   | Steel, stainless           |                                   | 20-400 DC                         | CAT, Mitsubishi  | Wireless interface control, ArcReach®, Line-X® top cover, lift-off service door; optional stainless steel                                       | Cross country pipeline                                    |
|                      | Big Blue® 450 Duo CST™      | 82    | ●     | ●   | ●           | ●      | ●      | ●     | 3/16" |   | Steel, stainless           |                                   | 5-450 DC                          | Mitsubishi   | Dual operator in a compact package  | Construction, fabrication, pipe                           |
|                      | Big Blue® 500 Pro           | 83    | ●     | ●   | ●           | ●      | ●      | ●     | 5/16" | Lift eye, generally mounted on optional trailer | Steel, stainless           | 3-ph: 20,000<br>1-ph: 12,000      | 20-500 DC                         | Kubota   | Quiet, fuel efficient; optional ArcReach®, wireless interface control   | Construction, repair                                      |
|                      | Big Blue® 600 Series        | 83    | ●     | ●   | ●           | ●      | ●      | ●     | 3/8"  |   | Steel, stainless           |                                   | 20-600 DC                         | Kubota (Pro), Deutz (Air Pak)  | Quiet, powerful, fuel efficient; optional ArcReach®, wireless interface control – Air Pak™ model has ArcReach® standard and adds air compressor | Construction, repair, maintenance, mining, rail           |
| Big Blue® 800 Series | 84                          | ●     | ●     | ●   | ●           | ●      | ●      | 1/2"  |       | Steel, stainless                                |                            | 20-800 DC                         | Deutz                             | ArcReach®, dual operator; optional wireless interface control – Air Pak™ model adds air compressor | Construction, repair, maintenance, mining, rail   |   |

### Product Key

Class: ● Light industrial ● Industrial ● Heavy industrial Capability: ● Designed for this process ● Capable of this process  
 New! or Improved! products appear in blue type. \*If using self-shielded wire, use CV weld output. \*\*With appropriate Spectrum plasma cutter.

# Fusion 160

See literature ED/2.8

Delivers a smooth, stable arc from either engine power or 120/240-volt utility power, providing a unique combination of versatility and productivity in a lightweight package.



## POWER SHIFT

### Work anywhere convenience.

PowerShift technology provides weld capabilities using either the Fusion 160 gasoline engine or 120/240-volt utility power. You'll have the confidence of knowing

that you can weld virtually anywhere with just one machine – outdoors with engine or utility power and indoors with utility power. The multi-voltage plug (MVP™) makes it easy to connect the welder to either 120- or 240-volt power.

**Easier to transport.** At only 242 pounds, the Fusion 160 is up to 45 pounds less than similar machines, so moving it is easier and faster. Less time is spent waiting, and more work can get done.

**Less rework.** Inverter technology delivers a smooth, stable stick arc that's forgiving of variations in arc length and travel speed, so it's easier to produce clean welds that meet specifications – and avoid the time and expense of rework.

Light industrial ● CC DC 1 Phase

### Process

- Stick (SMAW)

### Gasoline engine

**Kohler CH440:** 13.4 hp at 3,600 rpm  
One-cylinder, four-cycle, OHV, air-cooled

*Note: Engine is warranted separately by engine manufacturer.*

### Most popular accessories

- Lifting Eye 195353 (pg 120)
- Running Gear 301246 (pg 120)
- Twist Lock Adapter Cord 301489 (pg 120)
- Protective Cover 301245 (pg 120)

Visit [MillerWelds.com](http://MillerWelds.com) or your distributor for other Miller® options and accessories.

| Gasoline | Stock Number                           | Input Power      | Welding Mode | Welding Process | Amperage Range  | Rated Output at 104°F (40°C)  | Amps Input at Rated Output, 50/60 Hz, 1-Phase | Single-Phase Generator Power at 104°F (40°C) | Dimensions   | Net Weight       |
|----------|--|------------------|--------------|-----------------|---|---|---|--|--|------------------|
|          | (907773)<br>Kohler with electric start | Engine power     | CC/DC        | DC stick        | 30-160  | 160 A at 26.4 V, 20% duty cycle<br>110 A at 24.4 V, 100% duty cycle | –   | Peak: 6,500 watts<br>Continuous: 6,200 watts | H: 24.75 in. (629 mm)<br>W: 20.125 in. (510 mm)<br>D: 31.25 in. (794 mm) | 242 lb. (110 kg) |
|          |  | PowerShift 120 V | 30-100       |                 | 90 A at 23.6 V, 40% duty cycle                                      | 22.7  | –   |  |  |                  |
|          |  | PowerShift 240 V | 30-160       |                 | 160 A at 26.4 V, 20% duty cycle<br>110 A at 24.4 V, 100% duty cycle | 25.0  | –   |  |  |                  |

# Blue Star® 185

See literature ED/2.5

Reliable outdoor portable power – great for farm, ranch, maintenance, construction and hobbyists.



**Compact and portable.** With a small footprint, the Blue Star uses little truck space. Optional running gear also makes it one-man portable.

**All engine controls are on front panel.**

**Stick and TIG capable.**

**Accu-Rated™ peak generator power** is usable for maximum generator loads such as plasma cutting, Millermatic® MIG welders and motor starting.

**Includes electric start, 120-volt GFCI and 240-volt receptacles, 6.25-gallon fuel capacity, auto-idle and engine hour meter.**

Light industrial ● CC DC

### Processes

- Stick (SMAW) ▪ TIG (GTAW)

### Gasoline engine

**Kohler CH440:** 13.4 hp at 3,600 rpm  
One-cylinder, four-cycle, OHV, air-cooled

*Note: Engine is warranted separately by engine manufacturer.*

### Most popular accessories

- Lifting Eye 195353 (pg 120)
- Running Gear 301246 (pg 120)
- Protective Cover 301245 (pg 120)

Visit [MillerWelds.com](http://MillerWelds.com) or your distributor for other Miller® options and accessories.

| Gasoline | Stock Number       | Welding Mode | Welding Process | Amperage Range | Rated Output at 104°F (40°C)                                    | Single-Phase Generator Power at 104°F (40°C) | Dimensions   | Net Weight       |
|----------|--------------------|--------------|-----------------|----------------|---|--|--|------------------|
|          | (907664)<br>Kohler | CC/DC        | DC stick/TIG    | 60-195         | 185 A at 25 V, 20% duty cycle<br>150 A at 25 V, 100% duty cycle | Peak: 6,500 watts<br>Continuous: 6,200 watts | H: 24.75 in. (629 mm)<br>W: 20.625 in. (524 mm)<br>D: 31.25 in. (794 mm) | 296 lb. (134 kg) |

# Bobcat™/Trailblazer® Gas Model Comparison – Which is Right for You?

\*Based on typical usage – 150 amps welding 40% of the time; 20 amps generator power 30% of the time; and idling without load 30% of the time.

## Bobcat: The most popular welder/generator

- Dependable power and weld output
- Cost-effective multiprocess welder/generator
- Easy to maintain
- Quietest in its class



## Trailblazer: The best performer in the industry

- Unbeatable arc performance
- Independent welder and generator power system
- Exclusive technologies – Auto-Speed™ and Excel™ power
- Most fuel efficient and quietest in its class



| Sound Levels (at 23 feet)                                  | Bobcat 225 (page 76)                               | Bobcat 260 (page 76)   | Trailblazer 325 (page 78)  |
|--|--|--|--|
| At Maximum Load / At 150 Amps                              | 73.5 dB/ 72 dB                                     | 72.5 dB/ 72 dB   | 74 dB/65 dB  |
| Sound Quality  | Good   | Very good  | Excellent  |
| Fuel System  |  |  |  |
| Typical Runtime per 12-Gallon Tank*                        | 13 hours   | 13/ 15.5 hours with EFI  | Up to 21 hours with options  |
| Efficiency   | Good   | Good/ Very good with EFI   | Excellent  |
| Type   | Gasoline   | Gasoline or LP   | Gasoline or LP   |
| Delivery   | Carburetor   | <b>Carburetor or EFI available</b>                               | <b>Carburetor or EFI available</b>   |
| Generator  |  |  |  |
| Peak Watts   | 11,000 watts                                       | 11,000/ 12,000 watts with EFI                                    | 12,000 watts   |
| Clean Power Quality  | Very good/ Excellent                               | Very good/ Excellent   | Excellent  |
| Power While Welding  | Fair/ Good – With voltage control set near maximum | Good – Easier to fine-tune with arc voltage control near maximum | Independent weld and generator power with no interaction between tools and welding arc       |
| Excel™ Power Generator (120 V, 60 Hz at all engine speeds) | –  | –  | <b>Excel power available</b>   |
| Weld Performance   |  |  |  |
| Stick  | Good/ Very good                                    | Very good  | Excellent  |
| MIG – Wire (solid/ FCAW), Steel                            | Fair (.035 in.)                                    | Good (.035–1/16 in.)   | Excellent (.023–1/16 in.)  |
| MIG – Wire, Aluminum w/ Spool Gun                          | Fair/ Good (add WC-115A with contactor)            | Very good (add WC-115A with contactor)                           | Excellent (add WC-24)  |
| DC TIG (steel)   | Good   | Very good  | Excellent  |
| AC Weld  | 60–160 amps  | 40–260 amps  | Add Dynasty® (page 56)   |
| Carbon Arc Gouging   | –  | Good<br>Carbons: Rated 3/16 in.                                  | Very good<br>Carbons: Rated 3/16 in., Capable 1/4 in.  |
| Key Features   |  |  |  |
| Digital Meters   | –  | –  | With Sunvision™  |
| Maintenance Displays                                       | Hours/ Oil change                                  | Hours/ Oil change/ Fuel  | Hours/ Oil change/ Fuel/ rpm   |
| Battery Charge/ Crank Assist                               | –  | –  | <b>12 and 24 volt available</b>  |
| 14-pin Receptacle  | –  | –  | With Auto Remote Sense™  |
| Remote Capabilities  | Remote start/stop standard                         | Remote start/stop standard (on gas and diesel models)            | ArcReach technology standard (on most models)<br><b>Wireless interface control available</b> |

# Bobcat™/Trailblazer®/Big Blue® Air Pak™ Comparison – Which is Right for You?

Cost-effective welder/generator/air compressor/battery charger



AC/DC multiprocess welder/generator/air compressor/battery charger



Quiet and powerful multiprocess welder/generator/air compressor



Heavy-duty, dual-operator welder/generator/air compressor



|                             | Bobcat 200 Air Pak (page 75)                                    | Trailblazer 302 Air Pak (page 81)            | Big Blue 600 Air Pak (page 83)  | Big Blue 800 Duo Air Pak (page 84)  |
|-----------------------------|---|--|---|---|
| Compressed Air              | 30 cfm, 175 psi   | 31 cfm, 160 psi                              | 60 cfm, 100 psi   | 60 cfm, 100 psi   |
| Battery Charge/Crank Assist | 12 and 24 volt  | 12 and 24 volt                               | –   | –   |
| Generator Power             | Single-phase  | Peak: 8,000 watts<br>Continuous: 6,500 watts | Peak: 13,000 watts<br>Continuous: 11,000 watts                              | Peak: 15,000 watts<br>Continuous: 12,000 watts                              |
|                             | Three-phase   | –  | –   | Peak: 27,000 watts<br>Continuous: 20,000 watts                              |
| Weld Output Range           | 30–210 amps (CV/DC, CC/DC)                                      | 10–300 amps (CV/DC, CC/DC, CC/AC)            | 20–600 amps (CV/DC, CC/DC)  | Single weld mode: 40–800 amps<br>Dual weld mode: 20–400 amps (CV/DC, CC/DC) |
| Fuel Type                   | Gas/Diesel  | Gas  | Diesel  | Diesel  |
| Size                        | 29.78 x 20 x 44.61 in. (gas)<br>29.75 x 20 x 47.25 in. (diesel) | 28 x 20 x 59.625 in.                         | 46 x 28.5 x 69.5 in.  | 46 x 28.5 x 69.5 in.  |
| Weight                      | 514 lb. (gas), 618 lb. (diesel)                                 | 771 lb.                                      | 2,040 lb.   | 2,095 lb.   |
| Remote Capabilities         | –   | –  | ArcReach technology standard<br><b>Wireless interface control available</b> | ArcReach technology standard<br><b>Wireless interface control available</b> |

# Bobcat™ 200 Air Pak™ See literature ED/4.36

Quiet, fuel-efficient all-in-one that maintains power capabilities in a compact, lightweight footprint and is backed by industry-leading reliability and performance.



Bobcat 200 Air Pak (gas)

Bobcat 200 Air Pak Diesel

**Maximize available payload.** Reduce weight by up to 600 pounds and increase available payload by up to 24 cubic feet by reducing the equipment on the truck.

**Reduce fuel consumption.** Minimize fuel costs by reducing truck engine idle time by as much as 75 percent, or if you have a separate engine-driven compressor by only operating one engine.

**Minimize operating costs.** Potentially save more than \$50,000 over ten years from increased fuel efficiency, decreased maintenance costs and increased asset life.

**Advanced Auto-Speed™ technology** automatically adjusts engine speed to match weld and battery charge demands – reducing fuel consumption, maintenance costs and noise for more efficient jobsites.

**Industrial rotary-screw air compressor.** Easily outperforms and outlasts reciprocating compressors. Many air tools can be powered by the compressor including most 3/4-inch impact wrenches. Immediately supplies 30 cfm at 175 psi, 100 percent duty cycle, continuous air output.

**210-amp welder.** Maximize downtime and delays by making metal repairs in the field to stay on schedule.

**6,500-watt generator power** to support jobsite tools, lights, and high-demand applications like plasma cutters and TIG welders.

**Battery charge/crank assist.** Provides up to 100 amps at idle to quickly charge 12- and 24-volt batteries. Jobsite equipment with weak batteries can get up to 300 amps of crank assist.

Industrial 

**Process**

- Stick (SMAW) ▪ MIG (GMAW)<sup>1</sup>
- Flux-cored (FCAW)<sup>1</sup> ▪ DC TIG (GTAW)<sup>2</sup>

<sup>1</sup>With voltage-sensing feeder.

<sup>2</sup>Two-piece TIG torch recommended.

**Engines**

**EFI gas: Kohler ECH730**

23.5 hp at 3,600 rpm  
Twin-cylinder, four-cycle, overhead valve, industrial, air-cooled

**EPA Tier 4 Final Diesel: Kubota D722**

19 hp at 3,600 rpm  
Three-cylinder, industrial, liquid-cooled

*Note: Engines are warranted separately by engine manufacturer.*

**Most popular accessories**

- ArcReach® SuitCase® Feeders (pg 18)
- Spoolmate™ 200 300497 (pg 27)
- Spoolmatic® 30A 130831 (pg 28)
- Spectrum® 375 X-TREME™ (pg 94)
- Multi-Terrain Running Gear 301460 (pg 120)
- Full KVA Adapter Cord 300517 (pg 120)
- Protective Cover (pg 120)
  - 301475 Gas without running gear
  - 301476 Gas with running gear
  - 301531 Diesel without running gear
  - 301532 Diesel with running gear
- Remote Output Panel Kit 951850 (pg 120)
- HWY-Mid Frame Trailer 301438 (pg 121)
- 25 ft. Battery Charge/Jump Cables with Plug 300422
- Air Compressor Oil Heater 301448
- Air Dryer Kit 301488
- Spool Gun Extension Hose and Cable Kit 132228

*Visit MillerWelds.com or your distributor for other Miller® options and accessories.*

|          | Model/Stock Number                        | Welding Mode  | Welding Process | Amp/Volt Ranges | Rated Weld Output at 104°F (40°C)  | Single-Phase Generator Power at 104°F (40°C) | Dimensions   | Net Weight       |                |
|----------|---|---|-----------------|-----------------|--|--|--|------------------|----------------|
| Gasoline | Bobcat 200 Air Pak (907771) Kohler        | CC/DC   | DC stick/TIG    | 30-210 A        | 120 A at 25 V, 100% duty cycle<br>140 A at 26 V, 60% duty cycle<br>210 A at 28 V, 20% duty cycle | Peak: 8,000 watts<br>Continuous: 6,500 watts | H: 24.25 in. (616 mm)<br>H: 29.78 in. (756 mm) to top of exhaust<br>W: 20 in. (508 mm)<br>D: 44.61 in. (1,133 mm)  | 514 lb. (233 kg) |                |
|          |   | CV/DC   | MIG/FCAW        | 15-26 V         | 120 A at 20 V, 100% duty cycle<br>140 A at 21 V, 60% duty cycle<br>210 A at 25 V, 20% duty cycle |  |  |                  |                |
| Diesel   | Bobcat 200 Air Pak Diesel (907760) Kubota | CC/DC   | DC stick/TIG    | 30-210 A        | 120 A at 25 V, 100% duty cycle<br>140 A at 26 V, 60% duty cycle<br>210 A at 28 V, 20% duty cycle | Peak: 8,000 watts<br>Continuous: 6,500 watts | H: 28.875 in. (734 mm)<br>H: 29.75 in. (756 mm) to top of exhaust<br>W: 20 in. (508 mm)<br>D: 47.25 in. (1,200 mm) | 618 lb. (280 kg) |                |
|          |   | CV/DC   | MIG/FCAW        | 15-26 V         | 120 A at 20 V, 100% duty cycle<br>140 A at 21 V, 60% duty cycle<br>210 A at 25 V, 20% duty cycle |  |  |                  |                |
|          | Rotocomp Air Compressor                   | Features  |                 |                 | Free Air Delivery  |  | Working Pressure   | Duty Cycle       | Oil Capacity   |
|          |   | Rotary screw with electric clutch for on/off, oil change intervals of 500 hours |                 |                 | 30 cfm (0.85 m <sup>3</sup> /min.) at 3,600 rpm  |  | 80-175 psig  | 100%             | 2 qt. (1.89 L) |

# Bobcat™ Series Gas, LP and Diesel



**NEW!** Improved Bobcat 225 and new Bobcat 260 now with remote start/stop (not available on LP).

Now available with remote start/stop, the legendary Bobcat welder/generator is reliable, powerful and durable.

## Remote start/stop

**Take control and eliminate engine noise. Standard on most models (see page 77 chart for exceptions).** Easily turn your Bobcat machine on and off remotely so it only runs when you need it. Get more out of each tank, extend time between maintenance and work without the hassle of walking back to your machine.



## Savings on fuel and maintenance

**Remote start/stop allows you to quickly turn off your Bobcat welder/generator when it is not in use.** With fewer engine hours, you will spend less money on fuel and less time and money on maintenance.

SAVE UP TO **\$1,500** ANNUALLY ON FUEL AND MAINTENANCE BY SHUTTING THE MACHINE OFF.

## Easier and more reliable engine starts

**Carbureted gas Bobcat welder/generators now have eChoke technology,** which automatically sets the proper air/fuel mixture and eliminates the need to manually engage the choke, so cold-starting is now hands free.

eChoke is a trademark of Kohler Co.

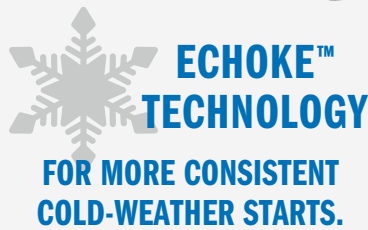

## Less noise

**Reduce the number of machines running on a jobsite** and increase your awareness of potential warning sounds when you easily turn your Bobcat welder/generator off with remote start/stop.

**0dB** WHEN YOU DON'T NEED POWER, TURN THE MACHINE OFF REMOTELY.

## Versatile AC and DC welding

**Provides AC and DC welding output** for greater versatility and quality welds on all types of metals. DC is smooth and easy to run while AC stick is used when arc blow occurs.

## Compact design

**Bobcat welder/generators can easily be moved around and take up less space,** leaving more room on your truck for other equipment and tools.

## Bobcat™ 225 (Gas) See literature ED/4.41

Cost-effective, multiprocess welder/generator primarily used for stick welding. Great for farm, ranch and maintenance/repair.

Features three DC stick/TIG controls, one AC stick/TIG control and one wire range for output control. Stick ranges designed for 3/32, 1/8 and 5/32 inch. Very easy to set.



## Bobcat™ 3 Phase (Gas) See literature ED/4.33

Designed for farm and ranch owners in need of single- and three-phase power to run 480-volt three-phase pivot irrigation systems or to provide backup power for farm and/or ranch.

## Bobcat™ 260 (Gas, LP or Diesel) See literature ED/4.42

**MOST POPULAR!** Multiprocess welder/generator capable of carbon arc gouging features a larger stabilizer for less spatter and smoother arc. Ideal welder/generator for maintenance/repair, construction or farm/ranch.

Convenient front panel fuel gauge.

Precise amperage settings with wide range for optimal stick/flux-cored welding.

Features four AC/DC stick/TIG controls and two wire ranges for output control. Stick ranges designed for 3/32, 1/8, 5/32 and 3/16 inch. Very easy to set.



### Add optional electronic fuel injection (EFI) – improved fuel efficiency for maximum productivity and profitability

Adding EFI to your Bobcat 260 welder/generator provides multiple benefits. With EFI you'll get faster, more reliable starts in any weather – no choke adjustments needed. EFI-equipped Bobcat 260 machines are also up to 42 percent more fuel efficient than standard carbureted models, improving profitability. Plus, refueling less frequently means you'll spend more of your time welding, improving productivity.

\*Electric fuel pump recommended for operation at altitudes above 5,000 feet.

\*\*For LP model order Hose and LP Tank Mounting Assembly (300917) separately.

Industrial 

### Processes

- AC/DC stick (SMAW)
- MIG (GMAW)<sup>1</sup> = Flux-cored (FCAW)<sup>1</sup>
- AC<sup>2</sup>/DC TIG (GTAW)
- Air carbon arc cutting and gouging (CAC-A)<sup>3</sup> (rated 3/16 in. carbons)

<sup>1</sup> With voltage-sensing feeder.

<sup>2</sup> With Dynasty® 210 Series.

<sup>3</sup> Bobcat 260 models only.

### Engines

**Gas: Kohler CH730 with eChoke™**

23.5 hp at 3,600 rpm

**EFI gas: Kohler ECH730**

23 hp at 3,600 rpm

**LP: Kohler CH730**

Liquid withdrawal LP system

21.5 hp at 3,600 rpm

V-twin-cylinder, four-cycle, overhead valve, industrial, air-cooled

**EPA Tier 4 Final Diesel: Kubota D722**

19 hp at 3,600 rpm

Three-cylinder, industrial, liquid-cooled

*Note: Engines are warranted separately by engine manufacturer.*

### Most popular accessories

- ArcReach® SuitCase® Feeders (pg 18)
- Dynasty® 210 Series (pg 56)
- Spectrum® 625 X-TREME™ (pg 94)
- Running Gear (pg 120)
- Protective Cage with Cable Holders (pg 120)
- Hose and LP Tank Mounting Assembly (pg 120)
- Remote Oil Drain/Filter Kit (pg 120)
- Full KVA Adapter Cord 300517 (pg 120)
- Protective Cover (pg 120)
- Remote Output Panel Kit 951850 (pg 120)
- HWY-Mid Frame Trailer (pg 121)
- Remote Start/Stop Fob Replacement 286385
- GFCI Panel Mount 120 VAC Duplex Kit 300975
- Electric Fuel Pump Kit 300976 (gas models only, recommended for operation at altitudes above 5,000 ft.)
- Spark Arrestor Kit 300924 (gas models only)

Visit [MillerWelds.com](http://MillerWelds.com) or your distributor for other Miller® options and accessories.

|           | Model             | Stock Number   | Welding Mode   | Welding Process | Amp/Volt Ranges | Rated Output at 104°F (40°C)                                    | Generator Power at 104°F (40°C)   | Dimensions  | Net Weight          |
|-----------|-------------------|--|----------------|-----------------|-----------------|---|---|---|---------------------|
| Gasoline  | Bobcat 225        | (907791001) Kohler<br>(907791) Kohler with GFCI  | CC/AC          | Stick/TIG       | 60-160 A        | 150 A at 25 V, 100% duty cycle                                  | Single-phase<br>Peak: 11,000 watts<br>Continuous: 9,500 watts   | H: 28 in. (711 mm)<br>H: 32.75 in. (832 mm)<br>to top of exhaust<br>W: 20 in. (508 mm)<br>D: 40.5 in. (1,029 mm)    | 485 lb.<br>(220 kg) |
|           |                   |  | CC/DC          | Stick/TIG       | 40-225 A        | 225 A at 25 V, 100% duty cycle                                  |   |   |                     |
|           |                   |  | CV/DC          | MIG/FCAW        | 19-28 V         | 200 A at 20 V, 100% duty cycle                                  |   |   |                     |
| Gasoline  | Bobcat 3 Phase    | Non-remote start/stop model<br>(907505) Kohler with GFCI   | CC/AC          | Stick/TIG       | 40-225 A        | 200 A at 25 V, 100% duty cycle                                  | Single-phase/three-phase<br>Peak: 11,000 watts<br>Continuous: 9,500/10,000 watts  |   | 495 lb.<br>(225 kg) |
|           |                   |  | CC/DC          | Stick/TIG       | 40-210 A        | 210 A at 25 V, 100% duty cycle                                  |   |   |                     |
|           |                   |  | CV/DC          | MIG/FCAW        | 19-28 V         | 200 A at 20 V, 100% duty cycle                                  |   |   |                     |
| Gas or LP | Bobcat 260        | (907792001) Kohler<br>(907792) Kohler with GFCI<br>(907792002) Kohler with electric fuel pump*<br>(907793) EFI Kohler<br>Non-remote start/stop model<br>(907794**) LP Kohler with GFCI | CC/AC          | Stick/TIG       | 40-260 A        | 260 A at 25 V, 60% duty cycle<br>225 A at 25 V, 100% duty cycle | Single-phase<br>Peak: 11,000 watts<br>Continuous: 9,500 watts<br><b>EFI model</b><br>Peak: 12,000 watts<br>Continuous: 10,500 watts | H: 28 in. (711 mm)<br>H: 32.75 in. (832 mm)<br>to top of exhaust<br>W: 20 in. (508 mm)<br>D: 40.5 in. (1,029 mm)    | 501 lb.<br>(227 kg) |
|           |                   |  | CC/DC          | Stick/TIG       | 40-260 A        | 260 A at 25 V, 100% duty cycle                                  |   |   |                     |
|           |                   |  | CV/DC          | MIG/FCAW        | 17-28 V         | 275 A at 25 V, 60% duty cycle<br>260 A at 28 V, 100% duty cycle |   |   |                     |
| Diesel    | Bobcat 260 Diesel | (907790) Kubota with GFCI  | CC/AC<br>CC/DC | Stick/TIG       | 40-260 A        | 260 A at 25 V, 100% duty cycle                                  | Single-phase<br>Peak: 11,000 watts<br>Continuous: 9,500 watts   | H: 28 in. (711 mm)<br>H: 34.375 in. (873 mm)<br>to top of exhaust<br>W: 20 in. (508 mm)<br>D: 45.375 in. (1,153 mm) | 638 lb.<br>(289 kg) |
|           |                   |  | CV/DC          | MIG/FCAW        | 17-28 V         | 275 A at 25 V, 60% duty cycle<br>260 A at 28 V, 100% duty cycle |   |   |                     |

# Trailblazer® Series Gas, LP and Diesel

See lit. ED/4.75 (Gas/LP) and ED/4.8 (Diesel)



**IMPROVED!**

Now available with wireless interface control (WIC) on select models.

Trailblazer welder/generators deliver unbeatable arc performance providing the smoothest, most stable arc in the industry. Miller®-exclusive Auto-Speed™ technology delivers superior runtimes, increased fuel efficiency, and improved welder/generator performance.

## ArcReach® remote control technology

Parameter control at the wire feeder or stick/TIG remote without needing a control cord. Standard on most

models (see page 79 chart for exceptions). An ArcReach system allows you to change weld settings from your ArcReach feeder or stick/TIG remote, saving a trip to the welding power source. ArcReach technology uses the existing weld cable to communicate welding control information between the feeder or stick/TIG remote and the power source. This technology eliminates the need for control cords, and their associated problems and costs. Learn more at [MillerWelds.com/arcreach](http://MillerWelds.com/arcreach)



## Unbeatable arc performance

**Dynamic DIG™** technology automatically adjusts the amount of current required to clear a short. Delivers a smoother, more consistent arc that can be tailored to match the application, material, fit-up and welder technique.



## Increased performance at high altitude

**Electric fuel pumps** are standard on all EFI models leading to better performance when operating at altitudes of 5,000 feet or greater.

## More productive jobsites

**Quieter jobsites** are more productive because work crews can communicate easier, and work can start earlier and end later – even in noise-sensitive areas.

## Auto-Speed™ technology

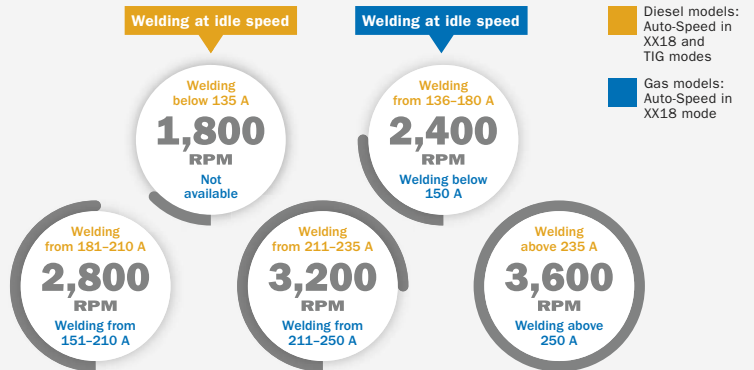

Get the welding power you need – plus reduced fuel consumption and lower noise levels for a more profitable jobsite. Trailblazer-exclusive Auto-Speed technology responds to weld requirements by automatically adjusting engine speed to a corresponding rpm level so the engine never works harder than necessary. Refueling time and operating costs are reduced, which means more productivity and profitability. Auto-Speed technology – available only from Miller.

## Options to Maximize Your Trailblazer® 325 Performance

### Electronic fuel injection (EFI) (gas models)

**Adding EFI to your Trailblazer welder/generator adds multiple benefits.** With EFI, you'll get faster, more-reliable starts in any weather – no choke adjustments needed. EFI-equipped Trailblazer machines are also up to 42 percent more fuel efficient than standard carbureted models, improving profitability. Plus, refueling less frequently means you'll spend more of your time welding, improving productivity.

Add Excel power to your Trailblazer with EFI for maximum fuel efficiency.

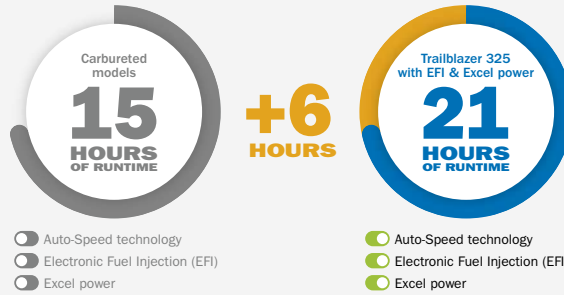

Based on typical usage – 150 amps welding 40% of the time; 20 amps generator power 30% of the time; and idling without load 30% of the time.

### Wireless interface control (WIC)

**Work hassle-free with full welder/generator control in the palm of your hand.**

With wireless interface control, you can change welding processes, adjust parameters, select and save preset programs, turn the machine on/off, get service reminders and more from wherever you are on the jobsite. Extend time between fill ups and maintenance intervals while eliminating the need to go back to your machine to make adjustments.

Wireless interface control is available as a factory-installed option on select models.



**WIRELESS**  
INTERFACE CONTROL

### Excel™ power

**Excel power delivers a full 2,400 watts (20 A) of 120-volt inverter-based, pure sine wave power at all speeds, including idle.** Unlike competitive machines that provide auxiliary power only at 3,600 rpm (max), with Excel power you can operate jobsite tools like grinders at quiet, fuel-saving speeds.

Refueling time and operating costs are reduced with Excel power, which means more productivity and profitability. Plus everyone on the jobsite gets a better working environment because noise levels are lowered. Excel power – available only from Miller.

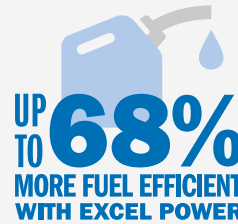

Based on generator-only use for total runtime.

### Battery charge/crank assist (gas models)

**Reduce downtime with battery charge/crank assist capability.** Designed and recommended for mechanics or anyone responsible for a fleet of trucks or equipment. By using your Trailblazer to charge dead batteries or jump a stubborn engine, you'll keep your crew working and the fleet up and running. Provides up to 75 amps of DC current to quickly charge 12- and 24-volt batteries. Jobsite equipment with weak batteries can get up to 350 amps of crank assist.

Note: Battery charge/jump cables (300422) must be ordered separately.

\*Electric fuel pump recommended for operation at altitudes above 5,000 feet.

\*\*For LP models order Hose and LP Tank Mounting Assembly (300917) separately.

Heavy industrial 

### Processes

- Stick (SMAW) • MIG (GMAW)<sup>1</sup>
- Flux-cored (FCAW)<sup>1</sup> • DC TIG (GTAW)<sup>2</sup>
- RMD<sup>3</sup> • Pulsed MIG (GMAW-P)<sup>3</sup>
- Air carbon arc cutting and gouging (CAC-A) (rated 3/16 in. carbons)

<sup>1</sup> With wire feeder.

<sup>2</sup> Two-piece TIG torch recommended.

<sup>3</sup> ArcReach models only with ArcReach Smart Feeder.

### Engines

**Gas: Kohler CH730**

23.5 hp at 3,600 rpm

**EFI gas: Kohler ECH730**

23 hp at 3,600 rpm

**LP: Kohler CH730LP**

23.5 hp at 3,600 rpm

Twin-cylinder, four-cycle, overhead valve, industrial, air-cooled

**EPA Tier 4 Final Diesel: Kubota D902**

24.8 hp at 3,600 rpm

Three-cylinder, industrial, liquid-cooled

Note: Engines are warranted separately by engine manufacturer.

### Most popular accessories

- SuitCase® Feeders (pg 18/47)
- ArcReach® Smart Feeder (pg 18/47)<sup>4</sup>
- ArcReach® Stick/TIG Remote (pg 47)<sup>4</sup>
- ArcReach® Heater (pg 47/92)<sup>4</sup>
- Spoolmatic® 30A/WC-24 Control 130831/137549 (pg 28/126)
- Running Gear (pg 120)
- Protective Cage with Cable Holders (pg 120)
- Hose and LP Tank Mounting Assembly (pg 120)
- Full KVA Adapter Cord (pg 120)
- Protective Cover (pg 120)
- Remote Output Panel Kit 951850 (pg 120)
- HWY-Mid Frame Trailer (pg 121)
- Electric Fuel Pump Kit 300976 (gas models only, recommended for operation at altitudes above 5,000 ft.)
- 25 ft. Battery Charge/Jump Cables with Plug 300422 (Trailblazer 325 EFI 907798004 only)
- Wireless Interface Control Screen Protectors 287594 (5 pack)

<sup>4</sup>For ArcReach models only.

Visit [MillerWelds.com](http://MillerWelds.com) or your distributor for other Miller® options and accessories.

|           | Model                  | Stock Number   | Welding Mode | Welding Process | Amp/Volt Ranges                 | Rated Output at 104°F (40°C)   | Single-Phase Generator Power at 104°F (40°C)   | Dimensions   | Net Weight  |
|-----------|------------------------|--|--------------|-----------------|---------------------------------|--|--|--|---|
| Gas or LP | Trailblazer 325        | (907797) Kohler<br>(907797001) Kohler with GFCI<br>(907797002) Kohler with GFCI and electric fuel pump*<br>(907797003) Kohler with WIC<br>(907798) EFI Kohler<br>(907798001) EFI Kohler with WIC<br>(907798002) EFI Kohler with Excel power<br>(907798003) EFI Kohler with GFCI, Excel power and WIC<br>(907775001**) Liquid LP Kohler with GFCI and Excel power | CC/DC        | Stick/TIG       | 10–325 A (Gas)<br>10–305 A (LP) | 325 A at 28 V,<br>100% duty cycle (Gas)<br>305 A at 28 V,<br>100% duty cycle (LP)  | Peak:<br>12,000 watts<br>10,500 watts (LP)<br>Continuous:<br>10,500 watts<br>10,000 watts (LP) | H: 28 in. (711 mm)<br>H: 32.75 in. (832 mm)<br>to top of exhaust<br>W: 20 in. (508 mm)<br>D: 40.5 in. (1,029 mm) | Gas:<br>460 lb.<br>(209 kg)<br>LP:<br>475 lb.<br>(215 kg) |
|           |                        | (907798004) EFI Kohler w/Excel power and battery charge/crank assist<br>(907798005) EFI Kohler w/Excel power, battery charge/crank assist and WIC<br>(907775**) Liquid LP Kohler with GFCI   | CV/DC        | MIG/FCAW        | 10–35 V                         | Excel power (optional)<br>2,400 watts<br>20 A at 120 V, 60 Hz<br>pure generator power<br>at idle speed and<br>while welding. |  |  |   |
| Diesel    | Trailblazer 325 Diesel | (907799) Kubota<br>(907799001) Kubota with GFCI<br>(907799002) Kubota with GFCI and Excel power<br>(907799003) Kubota with GFCI, Excel power and WIC   | CC/DC        | Stick/TIG       | 10–325 A                        | 325 A at 33 V,<br>100% duty cycle  |  | H: 28 in. (711 mm)<br>H: 34.5 in. (876 mm)<br>to top of exhaust<br>W: 20 in. (508 mm)<br>D: 45.5 in. (1,156 mm)  | 620 lb.<br>(281 kg)                                       |
|           |                        |  | CV/DC        | MIG/FCAW        | 10–35 V                         | 325 A at 33 V,<br>100% duty cycle  |  |  |   |

# REDEFINE *WHERE YOU WORK*

## New Remote Solutions for Miller® Engine Drives



Save fuel



Lower jobsite noise



Reduce time and money on maintenance



Improve jobsite safety



Remote Start/Stop

## *START & STOP* *WHERE YOU WORK*

Take control and eliminate engine noise. Easily turn your machine on and off remotely, so it only runs when you need it.

Remote start/stop is standard on Bobcat™ 225 and Bobcat™ 260 gas and diesel welder/generators.



Wireless Interface Control

## *TOTAL CONTROL* *WHERE YOU WORK*

You spoke. We listened. Now get full control of your machine in the palm of your hand from wherever you are on the jobsite and work hassle-free. Change welding processes, adjust parameters, select and save preset programs, turn the machine on/off, and more.

Wireless interface control is a factory-installed option on select Trailblazer® 325 and Big Blue® welder/generators.



Remote Output Panel Kit

## *ACCESS* *WHERE YOU WORK*

Locate your engine drive's output panels at the point of use. Minimize the need to climb onto the truck to make connections and optimize payload space.

Remote output panel kit is compatible with Bobcat™, Trailblazer® and Big Blue® welder/generators.

# Trailblazer® 302 Air Pak™ See literature ED/4.78

**Powerful all-in-one tool designed for repair and construction with multiprocess weld quality, generator power, air compressor and battery charge/crank assist.**



\*Electric fuel pump recommended for operation at altitudes above 5,000 feet.

**Superior arc performance.** Preset DIG settings optimized for the majority of stick welding applications, best-in-class wire arc performance, and two Lift-Arc™ TIG modes for most DC TIG applications.

**Strongest combined generator/compressor power.** Delivers an industry-leading 13,000 watts of peak generator power independent of weld settings.

**Rotary screw air compressor.** Delivers up to 31 cfm and 160 psi with no storage tank and runs many tools at idle speed. Provides 100 percent deliverable air, rated at an industry-high 104 degrees Fahrenheit. Front panel adjustment and automatic overpressure shutdown with indication. 30,000-hour life expectancy and warranted for three years by Miller.

**Battery charge/crank assist.** Provides selectable 12- or 24-volt battery charging with up to 450 amps of battery crank assist capability. Convenient front panel access.

Note: Battery charge/jump cables (300422) must be ordered separately.

Heavy industrial 

**Processes**

- AC/DC stick (SMAW)
- MIG (GMAW)<sup>1</sup> ▪ Flux-cored (FCAW)<sup>1</sup>
- AC<sup>2</sup>/DC<sup>3</sup> TIG (GTAW)
- Air carbon arc cutting and gouging (CAC-A) (rated 3/16 in. carbons, capable 1/4 in. carbons)

<sup>1</sup> With wire feeder.  
<sup>2</sup> With Dynasty® 210 Series.  
<sup>3</sup> Two-piece TIG torch recommended.

**Gasoline engine**

**Kohler CH750:** 27 hp at 3,600 rpm V-twin-cylinder, four-cycle, overhead valve, industrial, air-cooled  
 Note: Engine is warranted separately by engine manufacturer.

**Most popular accessories**

- SuitCase® Feeders (pg 18)
- Spoolmatic® 30A/WC-24 Control 130831/137549 (pg 28/126)

Visit MillerWelds.com or your distributor for other Miller® options and accessories.

|                |   |   |   |   |  |   |  |  |                  |
|----------------|---|---|---|---|--|---|--|--|------------------|
| Gasoline       | Stock Number<br>(907549001) Kohler<br>(907549) Kohler with GFCI and electric fuel pump*<br>(907549003) Kohler with GFCI, cooler/separator and electric fuel pump* |   | Welding Mode                                    | Welding Process                                 | Amp/Volt Ranges  | Rated Weld Output at 104°F (40°C)                               | Single-Phase Generator Power at 104°F (40°C)   | Dimensions   | Net Weight       |
|                |   |   | CC/DC   | Stick/TIG                                       | 10-300 A   | 280 A at 32 V, 100% duty cycle                                  | Peak: 13,000 watts<br>Continuous: 11,000 watts | H: 28 in. (711 mm)<br>H: 34.5 in. (876 mm) to top of exhaust<br>W: 20 in. (508 mm)<br>D: 59.625 in. (1,514 mm) | 771 lb. (350 kg) |
|                |   |   | CV/DC   | MIG/FCAW  | 13-35 V, 350 A   | 300 A at 32 V, 100% duty cycle<br>350 A at 32 V, 60% duty cycle |  |  |                  |
|                |   |   | CC/AC   | Stick/TIG                                       | 10-225 A   | 200 A at 25 V, 60% duty cycle                                   |  |  |                  |
| Air Compressor |   | Features  | Free Air Delivery                               |   |  | Working Pressure Constant                                       | Duty Cycle                                     | Oil Capacity   |                  |
|                |   | Rotary screw with electric clutch for on/off, oil change intervals of 500 hours | 31 cfm (0.88 m <sup>3</sup> /min.) at 3,600 rpm | 28 cfm (0.79 m <sup>3</sup> /min.) at 3,000 rpm | 22 cfm (0.62 m <sup>3</sup> /min.) at 2,400 rpm (idle) | 80-160 psig   | 100%   | 1.75 qt. (1.7 L)   |                  |

# Big Blue® 400 Pro See literature ED/5.7

**The professional welder's choice – designed with the professional in mind, the Big Blue 400 Pro is the best for ease of use, reliability and fuel economy.**



**IMPROVED!**  
 Now available with wireless interface control (WIC) on select models.

**ArcReach®**

**Parameter control at the wire feeder or stick/TIG remote without needing a control cord. Factory-installed option on select models.** See page 47 for more information.

**WIRELESS**  
 INTERFACE CONTROL

**Work hassle-free with full welder/generator control in the palm of your hand. Factory-installed option on select models.** See page 80 for more information.

**Dynamic DIG™ technology** automatically adjusts the amount of current required to clear a short. Delivers a smoother, more consistent arc that can be tailored to match the application, material, fit-up and welder technique.



**Industrial USB port.** Upload the latest software and download machine log files to retrieve information such as diagnostics and machine statistics.

**Quiet operation.** Only 71.6 decibels (96 Lwa) under full load. Improves jobsite communication and safety.

**Standard features** include digital meters with SunVision™, automatic idle, adjustable Hot Start™, output contactor control and 120-volt block heater.

Heavy industrial 

**Processes**

- Stick (SMAW) ▪ MIG (GMAW)<sup>1</sup>
- Flux-cored (FCAW)<sup>1</sup> ▪ DC TIG (GTAW)
- RMD<sup>2</sup> ▪ Pulsed MIG (GMAW-P)<sup>2</sup>
- Air carbon arc cutting and gouging (CAC-A) (rated 3/16 in. carbons)

<sup>1</sup> With wire feeder.  
<sup>2</sup> ArcReach models only with ArcReach Smart Feeder.

**Diesel engines**

**EPA Tier 4 Final choices**  
**Caterpillar C1.5T:** 24.7 hp at 1,800 rpm Turbo-charged, three-cylinder, industrial, liquid-cooled  
**Kubota V150S:** 20.2 hp at 1,800 rpm Four-cylinder, industrial, liquid-cooled  
**Mitsubishi S4L2:** 24.7 hp at 1,800 rpm Four-cylinder, industrial, liquid-cooled  
 Note: Engines are warranted separately by engine manufacturer.

**Most popular accessories**

- SuitCase® Feeders (pg 18/47)
- ArcReach® Smart Feeder (pg 18/47)<sup>3</sup>
- ArcReach® Stick/TIG Remote (pg 47)<sup>3</sup>
- ArcReach® Heater (pg 47/92)<sup>3</sup>
- Protective Cover 195301 (pg 120)

<sup>3</sup> For ArcReach models only.  
 Visit MillerWelds.com or your distributor for other Miller® options and accessories.

|        |  |  |              |                 |                 |  |  |   |   |
|--------|--|--|--------------|-----------------|-----------------|--|--|---|---|
| Diesel | Stock Number<br>(907774) CAT<br>(907774001) CAT with ArcReach<br>(907774003) CAT with ArcReach and WIC<br>(907732) Kubota<br>(907732001) Kubota with ArcReach<br>(907732013) Kubota with ArcReach and WIC<br>(907733) Mitsubishi<br>(907733001) Mitsubishi with ArcReach<br>(907733002) Mitsubishi with ArcReach and WIC |  | Welding Mode | Welding Process | Amp/Volt Ranges | Rated Output at 104°F (40°C)   | Single-Phase Generator Power at 104°F (40°C)   | Dimensions  | Net Weight  |
|        |  |  | CC/DC        | Stick/TIG       | 20-400 A        | 300 A at 32 V, 100% duty cycle<br>350 A at 27 V, 100% duty cycle<br>400 A at 24 V, 100% duty cycle | Peak: 12,000 watts<br>Continuous: 10,000 watts | H: 32 in. (813 mm)<br>W: 26.25 in. (667 mm)<br>D: 56 in. (1,422 mm) | CAT: 1,038 lb. (471 kg)<br>Kubota: 950 lb. (431 kg)<br>Mitsubishi: 993 lb. (450 kg) |
|        |  |  | CV/DC        | MIG/FCAW        | 14-40 V         |  |  |   |   |
|        |  |  |              |                 |                 |  |  |   |   |

# Big Blue® 400 PipePro® See literature ED/5.8

Designed for the transmission pipeline welder – the Big Blue 400 PipePro, with wireless interface control standard, offers superior downhill stick arc characteristics, as well as MIG/flux-cored capabilities, to meet high-strength steel requirements for the most demanding pipeline jobs.



**IMPROVED!**  
Now with wireless interface control (WIC).

## WIRELESS INTERFACE CONTROL

Elevate your performance. Now get full control of your machine in the palm of your hand. Change welding processes, adjust parameters, select and save preset programs, turn the machine on/off, and more. Standard on all models. See page 80 for more information.

## ArcReach®

Parameter control at the wire feeder or stick/TIG remote without needing a control cord. Standard on all models. See page 47 for more information.

**Dynamic DIG™ technology** automatically adjusts the amount of current required to clear a short. Delivers a smoother, more consistent arc that can be tailored to match the application, material, fit-up and welder technique.



**Industrial USB port.** Upload the latest software and download machine log files to retrieve information such as diagnostics and machine statistics.

**Compact size and weight** optimizes truck space.

**LINE-X® cover** provides superior impact, corrosion and abrasion protection.

**Standard features** include wireless interface control, ArcReach, digital meters with SunVision™, automatic idle, adjustable Hot Start™, output contactor control, 120-volt block heater, engine coolant temperature gauge and lift-off service door. Also available with optional stainless steel enclosure.

### Heavy industrial ● CC CV DC

#### Processes

- Stick (SMAW) ■ MIG (GMAW)<sup>1</sup>
- Flux-cored (FCAW)<sup>1</sup> ■ DC TIG (GTAW)
- RMD<sup>®2</sup> ■ Pulsed MIG (GMAW-P)<sup>2</sup>
- Air carbon arc cutting and gouging (CAC-A) (rated 1/4 in. carbons)

<sup>1</sup>With wire feeder.

<sup>2</sup>With ArcReach Smart Feeder.

#### Diesel engines

##### EPA Tier 4 Final choices

**Caterpillar C1.5T:** 24.7 hp at 1,800 rpm Turbo-charged, three-cylinder, industrial, liquid-cooled

**Mitsubishi S4L2:** 24.7 hp at 1,800 rpm Four-cylinder, industrial, liquid-cooled

*Note: Engines are warranted separately by engine manufacturer.*

#### Most popular accessories

- SuitCase® Feeders (pg 18/47)
- ArcReach® Smart Feeder (pg 18/47)
- ArcReach® Stick/TIG Remote (pg 47)
- ArcReach® Heater (pg 47/92)
- Dynasty® 210 Series (pg 56)
- Full KVA Adapter Cord 300517 (pg 120)
- Single-Phase Full KVA Plug Kit 119172 (pg 120)
- Protective Cover 195301 (pg 120)
- Remote Output Panel Kit 951850 (pg 120)
- HWY-Mid Frame Trailer (pg 121)
- Wireless Interface Control Screen Protectors 287594 (5 pack)

Visit [MillerWelds.com](http://MillerWelds.com) or your distributor for other Miller® options and accessories.

| Diesel | Stock Number<br>(907806001) CAT<br>(907806) CAT w/stainless steel<br>(907805001) Mitsubishi<br>(907805) Mitsubishi w/stainless steel | Welding Mode | Welding Process | Amp/Volt Ranges | Rated Output at 104°F (40°C)   | Single-Phase Generator Power at 104°F (40°C)   | Dimensions  | Net Weight  |
|--------|--|--------------|-----------------|-----------------|--|--|---|---|
|        |  | CC/DC        | Stick/TIG       | 20-400 A        | 300 A at 32 V, 100% duty cycle<br>350 A at 27 V, 100% duty cycle<br>400 A at 24 V, 100% duty cycle | Peak: 12,000 watts<br>Continuous: 10,000 watts | H: 32 in. (813 mm)<br>W: 26.25 in. (667 mm)<br>D: 56 in. (1,422 mm) | CAT: 1,038 lb. (471 kg)<br>Mitsubishi: 993 lb. (450 kg) |
|        |  | CV/DC        | MIG/FCAW        | 14-40 V         |  |  |   |   |

# Big Blue® 450 Duo CST™ See literature ED/5.5

Durable dual-operator welder/generator delivers proven CST stick/TIG performance with two superior arcs in one compact package, for maximum productivity and efficiency.



**Two separate outputs with Tweco®-style receptacles** deliver up to 280 amps of output per operator.

**Quiet operation.** At 72.1 decibels (97 Lwa) under full load, it's quieter than most single-operator models. Improves jobsite communication and safety.

**Vandalism lockout kit (not shown).** Lockable hinged steel panel protects front control panels and ignition switch.

**Simple-to-operate process selector knob automatically sets proper DIG setting** on E6010 and E7018 electrodes for superior stick performance.

**Lift-Arc™** start for TIG starts without the use of high frequency.

**Remote amperage control** permits the use of standard and wireless amperage control devices.

**Increased efficiency.** More arcs and better fuel economy equal increased profits for your business. Estimated savings are 34 percent with a dual-operator unit versus two single-operator units.

### Heavy industrial ● CC DC

#### Processes

- Stick (SMAW) ■ DC TIG (GTAW)
- Air carbon arc cutting and gouging (CAC-A) (rated 3/16 in. carbons)

#### Diesel engine

##### EPA Tier 4 Final

**Mitsubishi S4L2:** 24.7 hp at 1,800 rpm Four-cylinder, industrial, liquid-cooled

*Note: Engine is warranted separately by engine manufacturer.*

#### Most popular accessories

- Full KVA Adapter Cord 300517 (pg 120)
- Single-Phase Full KVA Plug Kit 119172 (pg 120)
- Protective Cover 195301 (pg 120)
- HWY-Mid Frame Trailer 301438 (pg 121)
- Spark Arrestor Kit 195012

Visit [MillerWelds.com](http://MillerWelds.com) or your distributor for other Miller® options and accessories.

| Diesel | Stock Number<br>(907477) Mitsubishi | Process      | Output Mode                    | Amperage Range                             | Rated Output at 122°F (50°C)   | Single-Phase Generator Power at 122°F (50°C) | Dimensions  | Net Weight         |
|--------|-------------------------------------|--------------|--------------------------------|--|--------------------------------|--|---|--------------------|
|        |                                     | DC stick/TIG | Separate (dual outputs)        | 5-225 (each side)<br>5-280 (one side only) | 175 A at 27 V, 100% duty cycle | Continuous: 10,000 watts                     | H: 32 in. (813 mm)<br>W: 26.25 in. (667 mm)<br>D: 56 in. (1,422 mm) | 1,064 lb. (483 kg) |
|        | Paralleled (combined)               | 10-450       | 350 A at 27 V, 100% duty cycle |  |                                |  |   |                    |

# Big Blue® 500 Pro and 600 Series

See literature ED/11.0 (500) and ED/11.5 (600)

**Clean, quiet, multiprocess machines designed to give welders the output they need for heavy-duty applications on construction and fabrication sites.**



Big Blue 500 and 600 Pro

Big Blue 600 Air Pak

**IMPROVED!**

Now available with wireless interface control (WIC) on select models.

## ArcReach®

Parameter control at the wire feeder or stick/TIG remote without needing a control cord. Standard on all Deluxe and Air Pak™ models. See page 47 for more information.

## WIRELESS INTERFACE CONTROL

Work hassle-free with full welder/generator control in the palm of your hand. Factory-installed option on select models. See page 80 for more information.

### Heavy industrial

#### Processes

- Stick (SMAW) ▪ MIG (GMAW)<sup>1</sup>
- Flux-cored (FCAW)<sup>1</sup> ▪ DC TIG (GTAW)
- RMD<sup>2</sup> ▪ Pulsed MIG (GMAW-P)<sup>2</sup>
- Submerged arc (SAW)
- Air carbon arc cutting and gouging (CAC-A) (500: rated 5/16 in. carbons; 600: rated 3/8 in. carbons)

<sup>1</sup>With wire feeder.

<sup>2</sup>ArcReach models only with ArcReach Smart Feeder.

#### Diesel engines

##### EPA Tier 4 Final choices

##### 500 and 600 Pro: Kubota V2403

48.9 hp at 1,800 rpm  
Turbo-charged, four-cylinder, industrial, liquid-cooled

##### 600 Air Pak: Deutz TD2.9 L4

65.7 hp at 1,800 rpm  
Turbo-charged, four-cylinder, industrial, liquid-cooled

Note: Engines are warranted separately by engine manufacturer.

#### Most popular accessories

- SuitCase® Feeders (pg 18/47)
- ArcReach® Smart Feeder (pg 18/47)<sup>3</sup>
- ArcReach® Stick/TIG Remote (pg 47)<sup>3</sup>
- ArcReach® Heater (pg 47/92)<sup>3</sup>
- Dynasty 210® Series (pg 56)
- Full KVA Adapter Cord (pg 120)
- Full KVA Plug Kit (pg 120)
- Protective Cover (pg 120)
  - 301495 Kubota
  - 301113 Deutz
- Remote Output Panel Kit 951850 (pg 120)
- HWY-225 Trailer 301338 (pg 121)
- Desiccant Air Dry System (for Air Pak model only)
  - 195117 Side mount
  - 195117001 Rear mount
 Eliminates moisture in the air stream and prevents air line freeze-ups in cold climates
- Cold Weather Kit 301482
- Spark Arrestor Kit 195012
- Wireless Interface Control Screen Protectors 287594 (5 pack)

<sup>3</sup>For ArcReach models only.

Visit MillerWelds.com or your distributor for other Miller® options and accessories.

#### Electronic engine display

simultaneously displays fuel level, engine hours, coolant temperature, oil pressure, battery volts, and engine rpm. Also tracks oil change intervals and displays engine diagnostics for easier servicing.



#### Dynamic DIG™ technology

automatically adjusts the amount of current required to clear a short. Delivers a smoother, more consistent arc that can be tailored to match the application, material, fit-up and welder technique.



**Industrial USB port.** Quickly upload the latest software and download machine log files to retrieve in-depth information such as diagnostics and machine statistics.

**20,000 watts of pure generator power.** Plug in Miller® inverter-based power sources for additional welding arcs!

**Standard features** include digital meters with SunVision™, adjustable Hot Start™, output contactor control, automatic idle, thermal overload protection and 120-volt block heater.

**Deluxe and Air Pak™ models** add ArcReach technology, polarity reversing switch and vandalism lockout kit (protects control panel and receptacles).

**Ingersoll Rand ultra-reliable industrial rotary screw compressor (Air Pak™ model only).** 30,000-hour life expectancy. Independent on/off control for applications not requiring compressed air – allows greater fuel savings and longer compressor service intervals.

\*Big Blue 600 Series has welder truck specific models available – visit MillerWelds.com or your distributor.

| Model/Stock Number   | Welding Mode/Process  | Amp/Volt Ranges  | Rated Output at 104°F (40°C)  | Generator Power at 104°F (40°C)                                | Dimensions   | Net Weight   |
|--|---|--|---|--|--|--|
| <b>Big Blue 500 Pro</b><br>(907736) Kubota<br>(907736001) Kubota Deluxe model<br>(907736008) Kubota Deluxe model with WIC  | CC/DC (Stick/TIG)   | 20-500 A   | 400 A at 36 V, 100% duty cycle<br>450 A at 38 V, 100% duty cycle<br>500 A at 40 V, 100% duty cycle                | Three-phase<br>Peak: 27,000 watts<br>Continuous: 20,000 watts  | H: 46 in. (1,168 mm)<br>W: 28.5 in. (724 mm)<br>D: 69.5 in. (1,765 mm) | 1,750 lb. (794 kg)   |
|  | CV/DC (MIG/FCAW)  | 15-50 V  | Single-phase<br>Peak: 15,000 watts<br>Continuous: 12,000 watts  |  |  |  |
| <b>Big Blue 600 Pro*</b><br>(907737) Kubota<br>(907737001) Kubota Deluxe model<br>(907737003) Kubota Deluxe model with WIC | CC/DC (Stick/TIG)   | 20-600 A   | 600 Pro:<br>500 A at 40 V, 100% duty cycle<br>550 A at 42 V, 60% duty cycle<br>600 A at 42 V, 40% duty cycle      | Three-phase<br>Peak: 27,000 watts<br>Continuous: 20,000 watts  | H: 46 in. (1,168 mm)<br>W: 28.5 in. (724 mm)<br>D: 69.5 in. (1,765 mm) | 600 Pro:<br>1,750 lb. (794 kg)<br>600 Air Pak:<br>2,040 lb. (925 kg) |
|  | CV/DC (MIG/FCAW)  | 15-50 V  | 600 Air Pak:<br>500 A at 40 V, 100% duty cycle<br>575 A at 43 V, 100% duty cycle<br>600 A at 44 V, 60% duty cycle | Single-phase<br>Peak: 15,000 watts<br>Continuous: 12,000 watts |  |  |
| <b>Ingersoll Rand CE55 G1 Air Compressor</b><br>(Air Pak model only)   | <b>Features</b><br>Rotary screw with electric clutch for on/off, oil change intervals of 500 hours, life expectancy of 30,000 hours | <b>Free Air Delivery</b><br>Idle: 40 cfm (1.13 m³/min.)<br>Weld: 60 cfm (1.70 m³/min.) | <b>Working Pressure Constant</b><br>100 psig (7 bar)  | <b>Duty Cycle</b><br>100%                                      | <b>Oil Capacity</b><br>4 qt. (3.79 L)                                  |  |

Diesel

# Big Blue® 800 Series

See literature ED/14.0

**The most powerful lineup of diesel welder/generators in the industry. Robust output for welding and power generation; ideal for dual-operator applications on labor-intensive or limited-space jobsites.**



Big Blue 800 Duo Pro

Big Blue 800 Duo Air Pak

**IMPROVED!**

Now available with wireless interface control (WIC) on select models.

## ArcReach®

Parameter control at the wire feeder or stick/TIG remote without needing a control cord. Standard on all models. See page 47 for more information.

## WIRELESS INTERFACE CONTROL

Work hassle-free with full welder/generator control in the palm of your hand. Factory-installed option on select models. See page 80 for more information.

Note: WIC-equipped Big Blue 800 Series machines include two remotes so both operators have full control of their processes and parameters.

**Multi-arc welding.** One dependable engine – two independent arcs with up to 400 amps each. Or plug in additional inverters for a true multioperator work platform! Example: Two additional XMT machines equals four operators, up to 200 amps each. Premium quality arcs allow operators to work independently with no arc interaction. Multioperator welding has never been easier or more versatile.

**Increased efficiency.** More arcs and better fuel economy equal increased profits for your business. Estimated savings are 34 percent with a dual-operator unit versus two single-operator units.

**Simple paralleling switch** makes switching from a single operator to dual operators a breeze. Weld up to 400 amps per side when set up in dual-operator mode, or up to 800 amps in single-operator mode.

**Electronic engine display** simultaneously displays fuel level, engine hours, coolant temperature, oil pressure, battery volts and engine rpm. Also tracks oil change intervals and displays engine diagnostics for easier servicing. Air Pak model adds air pressure and compressor hours displays.



**Dynamic DIG™ technology** automatically adjusts the amount of current required to clear a short. Delivers a smoother, more consistent arc that can be tailored to match the application, material, fit-up and welder technique.



**Industrial USB port.** Upload the latest software and download machine log files to retrieve information such as diagnostics and machine statistics.

**20,000 watts of pure generator power.** Plug in Miller® inverter-based power sources for additional welding arcs!

**Standard features** include ArcReach, digital meters with SunVision™, automatic idle, 120-volt block heater and vandalism lockout kit (protects control panel and receptacles).

**Ingersoll Rand ultra-reliable industrial rotary screw compressor (Air Pak™ model only).** 30,000-hour life expectancy. Independent on/off control for applications not requiring compressed air – allows greater fuel savings and longer compressor service intervals.

Heavy Industrial ● **AC CV DC**

### Processes

- Stick (SMAW) ■ MIG (GMAW)<sup>1</sup>
- Flux-cored (FCAW)<sup>1</sup> ■ DC TIG (GTAW)
- RMD<sup>®2</sup> ■ Pulsed MIG (GMAW-P)<sup>2</sup>
- Submerged arc (SAW)
- Air carbon arc cutting and gouging (CAC-A) (rated 1/2 in. carbons)
- Stud (1/2 in.)

<sup>1</sup>With wire feeder.

<sup>2</sup>With ArcReach Smart Feeder.

### Diesel engine

#### EPA Tier 4 Final

**Deutz TD2.9 L4:** 65.7 hp at 1,800 rpm Turbo-charged, four-cylinder, industrial, liquid-cooled

Note: Engines are warranted separately by engine manufacturer.

### Most popular accessories

- SuitCase® Feeders (pg 18/47)
- ArcReach® Smart Feeder (pg 18/47)
- ArcReach® Stick/TIG Remote (pg 47)
- ArcReach® Heater (pg 47/92)
- Dynasty 210® Series (pg 56)
- Full KVA Adapter Cord 300517 (pg 120)
- Full KVA Plug Kit (pg 120)
  - 119172 Single-phase
  - 254140 Three-phase
- Protective Cover 301113 (pg 120)
- Remote Output Panel Kit 951850 (pg 120)
- HWY-225 Trailer 301338 (pg 121)
- Desiccant Air Dry System (Air Pak model only)
  - 195117 Side mount
  - 195117001 Rear mount
 Eliminates moisture in the air stream and prevents air line freeze-ups in cold climates
- Cold Weather Kit 301482
- Spark Arrestor Kit 195012
- Wireless Interface Control Screen Protectors 287594 (5 pack)

Visit [MillerWelds.com](http://MillerWelds.com) or your distributor for other Miller® options and accessories.

\*Big Blue 800 Duo Air Pak has welder truck specific models available – visit [MillerWelds.com](http://MillerWelds.com) or your distributor.

| Diesel   | Model/Stock Number*   | Welding Mode/Process   | Output Mode               | Amp/Volt Ranges              | Rated Output at 100% Duty Cycle at 104°F (40°C)                | Generator Power at 104°F (40°C)                               | Dimensions   | Net Weight   |
|--|---|--|---------------------------|------------------------------|--|---|--|--|
|  | Big Blue 800 Duo Pro (907751) Deutz<br>Big Blue 800 Duo Air Pak (907752) Deutz<br>Big Blue 800 Duo Air Pak (907752003) Deutz with WIC | CC/DC (Stick/TIG)  | Separate (dual outputs)   | 20-400 A                     | 400 A at 36 V (each side)                                      | Three-phase<br>Peak: 27,000 watts<br>Continuous: 20,000 watts | H: 46 in. (1,168 mm)<br>W: 28.5 in. (724 mm)<br>D: 69.5 in. (1,765 mm) | Duo Pro: 1,869 lb. (848 kg)<br>Duo Air Pak: 2,095 lb. (968 kg) |
|  | CV/DC (MIG/FCAW)  | Separate (dual outputs)  | 15-50 V                   | 400 A at 34 V (each side)    | Single-phase<br>Peak: 15,000 watts<br>Continuous: 12,000 watts |   |  |  |
|  |   | Paralleled (combined)  | 40-800 A                  | 700 A at 44 V, 800 A at 38 V |  |   |  |  |
|  |   | Paralleled (combined)  | 15-50 V                   | 750 A at 40 V, 800 A at 38 V |  |   |  |  |
| Ingersoll Rand CE55 G1 Air Compressor (Air Pak model only) | Features  | Free Air Delivery  | Working Pressure Constant | Duty Cycle                   | Oil Capacity   |   |  |  |
|  | Rotary screw with electric clutch for on/off, oil change intervals of 500 hours, life expectancy of 30,000 hours                      | Idle: 40 cfm (1.13 m <sup>3</sup> /min.)<br>Weld: 60 cfm (1.70 m <sup>3</sup> /min.) | 100 psig (7 bar)          | 100%                         | 4 qt. (3.79 L)   |   |  |  |

# MillerWeldsStore.com

**BUY MILLER® GEAR ONLINE. SHIRTS, HATS, MUGS, BANNERS AND MORE!**





Miller offers an array of versatile submerged arc components, including power sources, controls, wire drives, torches, tractors and a variety of other accessories.

## SubArc Digital Series

See literature AD/7.3

The SubArc Digital Series of power sources, interface controls and accessories include digital control and communication electronics designed to improve weld performance and simplify the integration of the equipment in more advanced applications.



**Heavy industrial** ●  
 CC CV AC/DC DC 3 Phase *SubArc DC Series is DC only.*

### Processes

- Submerged arc (SAW)
- Electroslag (ESW)
- Air carbon arc cutting and gouging (CAC-A)

### Most popular accessories

- 14-pin Insight Core™ Module 301072 (pg 70)  
Requires Insight Core to SubArc Digital Series Adapter Kit (301295)
- Insight ArcAgent™ Auto 301346 (pg 71)
- 15 ft. (4.6 m) SubArc Parallel Cable 260775015 (pg 123)
- 15 ft. (4.6 m) SubArc Tandem Cable 260878015 (pg 123)

Visit [MillerWelds.com](http://MillerWelds.com) or your distributor for other Miller® options and accessories.

**Two DC power source models and one AC/DC power source model.** Power sources have sufficient power capacity to cover applications from traditional DC single-arc to multi-wire tandem welding. In the case of electroslag welding or other high-current demand, two or more power sources can easily be paralleled (both DC and AC/DC machines).

**Low-voltage accessory operation and improved environmental protection.** The Digital Series accessories are powered with 24 VAC control voltage from the power source. All power sources, interface controls and wire drives are IP23 rated providing a high level of protection for harsh environments.

**Easy to integrate.** Our SubArc power sources are easy to integrate by using a standard Modbus® connection.

**All power sources feature thermal overload protection, line voltage compensation and Fan-On-Demand.™**

\*While idling.

| Model/Stock Number                                   | Amperage Range (CC Mode) | Voltage Range (Sub Arc Mode) | Rated Output                     | Amps Input at Rated Output, 60 Hz |            |              |             |               | Max Open-Circuit Voltage | Dimensions (Includes lift eye, but not strain relief)              | Net Weight            |
|--|--------------------------|------------------------------|----------------------------------|-----------------------------------|------------|--------------|-------------|---------------|--------------------------|--|-----------------------|
|  |                          |                              |                                  | 230 V                             | 460 V      | 575 V        | KVA         | KW            |                          |  |                       |
| <b>SubArc DC 650 Digital (907622)</b> 230/460/575 V  | 50-815 A                 | 20-44 V                      | 650 A at 44 V, 100% duty cycle   | 126<br>3.8*                       | 63<br>1.9* | 50.4<br>1.4* | 50<br>1.52* | 34.8<br>0.76* | 75 Vpk                   | H: 30 in. (762 mm)<br>W: 23 in. (584 mm)<br>D: 38 in. (965 mm)     | 593 lb.<br>(269 kg)   |
| <b>SubArc DC 1000 Digital (907624)</b> 230/460/575 V | 100-1,250 A              | 20-44 V                      | 1,000 A at 44 V, 100% duty cycle | 180<br>5.8*                       | 90<br>2.9* | 72<br>2.4*   | 73<br>3.2*  | 53<br>0.5*    | 68 Vpk                   |  | 682 lb.<br>(309 kg)   |
| <b>SubArc AC/DC Digital (907620)</b> 460 V           | 300-1,250 A              | 20-44 V                      | 1,000 A at 44 V, 100% duty cycle | —                                 | 122        | —            | 98          | 53            | 93 Vpk                   | H: 43 in. (1,092 mm)<br>W: 28 in. (711 mm)<br>D: 48 in. (1,219 mm) | 1,187 lb.<br>(538 kg) |

# SubArc Interface Control

See literature no. AD/7.3



**Easier setup and operation.** The SubArc Interface Digital control recognizes the power source and wire drive connected, and automatically configures the system for proper operation.

**Internal terminal strip** is able to integrate with positioners, sidebeams, turning rolls and other peripheral equipment.

### Most popular accessories

- SubArc Control Cables (pg 123)
  - 260622030 30 ft. (9.1 m)
  - 260622050 50 ft. (15 m)
  - 260622060 60 ft. (18.3 m)
  - 260622080 80 ft. (24.4 m)
  - 260622100 100 ft. (30.5 m)
  - 260622120 120 ft. (36.6 m)
  - 260622200 200 ft. (61.0 m)

Visit [MillerWelds.com](http://MillerWelds.com) or your distributor for other Miller® options and accessories.

| Stock Number                      | Input Power from Welding Power Source | Welding Power Source Type  | Weld Voltage and Amperage Capacity | Dimensions  | Net Weight        |
|-----------------------------------|---------------------------------------|--|------------------------------------|---|-------------------|
| SubArc Interface Digital (300936) | 24 VAC, 1-phase, 25 A, 50/60 Hz       | Constant voltage (CV), AC or DC, with remote contactor and output control capabilities | 0-100 V<br>0-1,500 A               | H: 11.5 in. (292 mm)<br>W: 12 in. (305 mm)<br>D: 7 in. (178 mm) | 15.8 lb. (7.2 kg) |

# SubArc Remote Operator Interface

See literature AD/7.3



Motor Control Digital



Remote Pendant Digital

**Point-of-use installation.** Remote Pendant can be handheld or secured at point of use to improve operation.

**Remote installation.** Motor Control can be remotely installed, resulting in reduced cables at the operator workstation.

**Side handles** on Remote Pendant provides option for handheld operation with full functionality of a traditional SubArc Interface.

### Most popular accessories

- SubArc Control Cables (see pg 123 for complete list)
  - 260622030 30 ft. (9.1 m)
  - 260622050 50 ft. (15 m)
  - 260622080 80 ft. (24.4 m)
- Continuum™ Control/Motor Cables (see pg 123 for complete list)
  - 263368015 15 ft. (4.6 m)
  - 263368025 25 ft. (7.6 m)
  - 263368050 50 ft. (15 m)

Visit [MillerWelds.com](http://MillerWelds.com) or your distributor for other Miller® options and accessories.

| Model/Stock Number  | Input Power from Welding Power Source | Welding Power Source Type  | Weld Voltage and Amperage Capacity | Dimensions  | Net Weight        |
|---|---------------------------------------|--|------------------------------------|---|-------------------|
| SubArc Motor Control Digital (301425)<br>(requires SubArc Remote Pendant Digital below and Continuum control/motor cable) | 24 VAC, 1-phase, 25 A, 50/60 Hz       | Constant voltage (CV), AC or DC, with remote contactor and output control capabilities | 0-100 V<br>0-1,500 A               | H: 11.5 in. (292 mm)<br>W: 12 in. (305 mm)<br>D: 7 in. (178 mm)     | 15.8 lb. (7.2 kg) |
| SubArc Remote Pendant Digital (301424)<br>(requires SubArc Motor Control Digital above and Continuum control/motor cable) | 42 VDC, 1 A                           |  |                                    | H: 11 in. (279 mm)<br>W: 10.63 in. (270 mm)<br>D: 3.125 in. (80 mm) | 3 lb. (1.4 kg)    |



Miller recommends



Customers count on Hobart® to provide an exceptional level of expertise and commitment in developing unique filler metal and flux solutions with them to meet current and future challenges.

Rely on Hobart for submerged arc applications and all your welding needs.

Visit [HobartBrothers.com](http://HobartBrothers.com) or your local distributor to learn more.

Questions? Hobart is here to help.

## SubArc Wire Drive 400 Digital Low Voltage

See literature AD/7.3



**SubArc Wire Drive 400 Digital Low Voltage** is a standard-speed, right-angle wire drive assembly.

### Most popular accessories

- Motor Extension Cables (pg 123)  
254232005 5 ft. (1.5 m)  
254232010 10 ft. (3 m)  
254232025 25 ft. (7.6 m)  
254232065 65 ft. (19.8 m)
- Drive Rolls (pg 123)
- Single-Wire Straightener 199733 (pg 123)
- Twin-Wire Straightener 301160 (for twin-wire torches only) (pg 123)
- Manual Single Slide (pg 123)

Visit [MillerWelds.com](http://MillerWelds.com) or your distributor for other Miller® options and accessories.

| Stock Number | Input Power | Input Power Cord | Rating         | Wire Feed Speed                 | Wire Diameter Capacity     | Net Weight       |
|--------------|-------------|------------------|----------------|---------------------------------|----------------------------|------------------|
| (300938)     | 38 VDC      | 4 ft. (1.2 m)    | 1/5 hp, 85 rpm | 30–400 ipm<br>(0.8–10.2 m/min.) | 3/32–3/16 in. (2.4–4.8 mm) | 26 lb. (11.8 kg) |

## SubArc Torches

See literature AD/7.3



**OBT 600 torch** has concentric flux flow nozzle. 600 amps at 100 percent duty cycle. For use with 1/16–5/32 inch (1.6–4.0 mm) wire.

**OBT 1200 torch** has concentric flux flow nozzle. 1,200 amps at 100 percent duty cycle. For use with 1/16–5/32 inch (1.6–4.0 mm) wire. OBT 1200 features a replaceable breakaway adapter end to prevent costly damage should torch run into an obstruction.

**1200-Amp Twin-Wire Torch (long).** 1,200 amps at 100 percent duty cycle. For use with 3/64–3/32 inch (1.2–2.4 mm) wire.

### Most popular accessories

- OBT 600 Torch Body Extensions (pg 123)  
043967 1 inch (25.4 mm)  
043969 2 inch (50.8 mm)  
043973 4 inch (101.6 mm)  
043975 6 inch (152.4 mm)
- OBT 1200 Torch Body Extension 043981 (pg 123)
- Contact Tips (pg 123)

Visit [MillerWelds.com](http://MillerWelds.com) or your distributor for other Miller® options and accessories.

| Model/Stock Number                              | Rated Output               | Wire Diameter Capacity     | Single/Twin | Torch Body Length    |
|---|----------------------------|----------------------------|-------------|----------------------|
| <b>OBT 600 (043923)</b>                         | 600 A at 100% duty cycle   | 1/16–5/32 in. (1.6–4.0 mm) | Single      | 10.25 in. (260.4 mm) |
| <b>OBT 1200 (043900)</b>                        | 1,200 A at 100% duty cycle | 1/16–5/32 in. (1.6–4.0 mm) | Single      | 17.25 in. (438.2 mm) |
| <b>1200-Amp Twin-Wire Torch (long) (301144)</b> | 1,200 A at 100% duty cycle | 3/64–3/32 in. (1.2–2.4 mm) | Twin        | 16.97 in. (431 mm)   |

## SubArc Flux Hopper Digital Low Voltage

See literature AD/7.3



**Improved flux delivery system.** Our SubArc Flux Hopper Digital Low Voltage utilizes a flux valve mechanism that assures continuous delivery of flux to the arc.

**Sight glass** allows the weld operator to visually monitor the remaining flux in the hopper.

**Versatile opening** is sized to allow hookup of any flux-hopper-mounted recovery system.

**Includes slag screen** to capture fused slag particles from entering the flux hopper.

### Most popular accessories

- Flux Hopper Extension Cables (pg 123)  
260623010 10 ft. (3 m)  
260623025 25 ft. (7.6 m)  
260623065 65 ft. (19.8 m)

Visit [MillerWelds.com](http://MillerWelds.com) or your distributor for other Miller® options and accessories.

| Stock Number | Input Power                               | Input Power Cord | Flux Capacity  | Net Weight    |
|--------------|---|------------------|----------------|---------------|
| (300942)     | 12 VDC (PWM signal from SubArc Interface) | 11 ft. (3.3 m)   | 25 lb. (11 kg) | 11 lb. (5 kg) |

# SubArc 3-Wheel Tractor

See literature AD/7.7



**Easy-to-use foot- or hand-operated clutch** allows for easy engagement of tractor drive and disengagement to move tractor into position.

**Flexible mast configuration** allows torch to be positioned in multiple weld zones and adapts to your weld application.

**SubArc Tractor Interface Digital** provides easy-to-operate single control for power source and tractor operation.

**Regulated travel speed** ensures your actual and set travel speeds are consistent, improving weld quality.

**Locking front wheel** can be set in place to desired travel path.

**Easily accommodates a 60-pound (27 kg) wire reel** for fewer time-consuming wire changeovers.

**Low-voltage operation and improved environmental protection.** The new digital series accessories are powered with 24 VAC control voltage from the power source. All power sources, interface controls and wire drives are IP23 rated providing a high level of protection for harsh environments.

### Package includes

- SubArc 3-Wheel Tractor
- SubArc Tractor Interface Digital
- SubArc Wire Drive 400 Digital Low Voltage
- 10 lb. (4.5 kg) capacity flux hopper with manual valve
- 60 lb. (27 kg) wire reel
- OBT 600 torch
- Wire straightener

### Required power source

- SubArc Digital Series (pg 86)

### Most popular accessories

- SubArc Control Cables (pg 123)
- Contact Tips (pg 123)
- Drive Rolls (pg 123)

Visit [MillerWelds.com](http://MillerWelds.com) or your distributor for other Miller® options and accessories.

| Stock Number | Input Power from Welding Power Source | Wire Feed Speed                 | Wire Diameter Capacity        | Gun Positioning Slides | Drive Motor | Travel Speed                   | Dimensions   | Net Weight                                   |
|--------------|---------------------------------------|---------------------------------|-------------------------------|------------------------|-------------|--------------------------------|--|--|
| (951755)     | 24 VAC, 1-phase, 50/60 Hz, 25 A       | 30-400 ipm<br>(0.8-10.2 m/min.) | 1/16-5/32 in.<br>(1.6-4.0 mm) | 3.5 in. (88.9 mm)      | 38 VDC      | 5-70 ipm<br>(0.13-1.75 m/min.) | H: 36 in. (914 mm)<br>W: 43.25 in. (1,149 mm)<br>D: 31.63 in. (803 mm) | 120 lb.<br>(54.4 kg)<br>without flux or wire |

# SubArc Portable Welding System

See literature AD/7.6

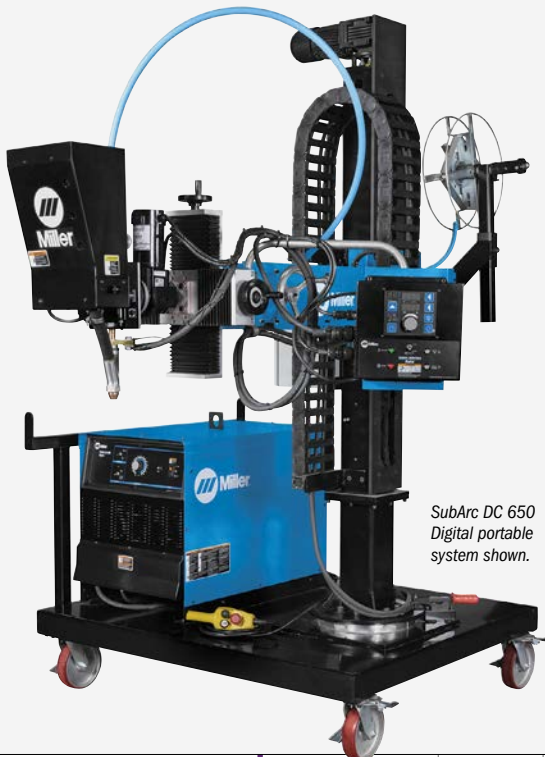

SubArc DC 650 Digital portable system shown.

**Self-contained system** for pressure vessel, pipe and general welding applications. Houses a power source, column and boom on a mobile platform.

**Built-in fork pockets and caster wheels** allow welding system to be brought to the joint.

**Easy positioning of the weld head** through use of integrated motorized column, manual telescoping boom, slide and 360-degree column rotation.

**Motorized column with pendant control and manual telescoping boom** provides 44 inches (1,117 mm) of vertical travel and 31 inches (787 mm) of horizontal travel respectively.

**Manual slide** provides 7.87 inches (200 mm) of fine vertical and horizontal torch adjustment.

### Systems include

- Portable column and boom
- SubArc Digital power source
- SubArc Interface Digital and control cable
- SubArc Wire Drive 400 Digital Low Voltage
- 25 lb. (11.3 kg) capacity flux hopper with valve
- 60 lb. (27 kg) wire reel and support assembly
- OBT 600 torch (650 system) or OBT 1200 torch (1000 system)
- Wire straightener
- Manual slide

### Most popular accessories

- 14-pin Insight Core™ Module 301072 (pg 70)  
Requires Insight Core to SubArc Digital Series Adapter Kit (301295)
- Insight ArcAgent™ Auto 301346 (pg 71)
- Contact Tips (pg 123)
- Drive Rolls (pg 123)

Visit [MillerWelds.com](http://MillerWelds.com) or your distributor for other Miller® options and accessories.

| Stock Number  | Supply Voltage  | Column Stroke        | Column Travel  | Boom Stroke        | Boom Travel | Base Rotation | Minimum Working Height                                   | Maximum Working Height                                       | Overall Height        |
|---|---|----------------------|----------------|--------------------|-------------|---------------|--|--|-----------------------|
| (951675) w/SubArc DC 650 Digital<br>(951676) w/SubArc DC 1000 Digital<br>(see page 86 for power source specs) | 120 V, 1-phase, 60 Hz<br>(see page 86 for power source requirement) | 44 in.<br>(1,117 mm) | Constant speed | 31 in.<br>(787 mm) | Manual      | 360°          | DC 650: 33.5 in. (851 mm)<br>DC 1000: 26.25 in. (667 mm) | DC 650: 77.5 in. (1,969 mm)<br>DC 1000: 70.25 in. (1,784 mm) | 102 in.<br>(2,590 mm) |



## ProHeat™ Induction Heating

**Induction heating is a simple and cost-effective heating process that can deliver fast and consistent heat. Applications that would typically require hours to heat can be done in minutes.**

- Welding fabrication and construction
- Preheating of welds
- Post-weld heat treatment (PWHT)
- Hydrogen bakeout
- Shrink fit applications

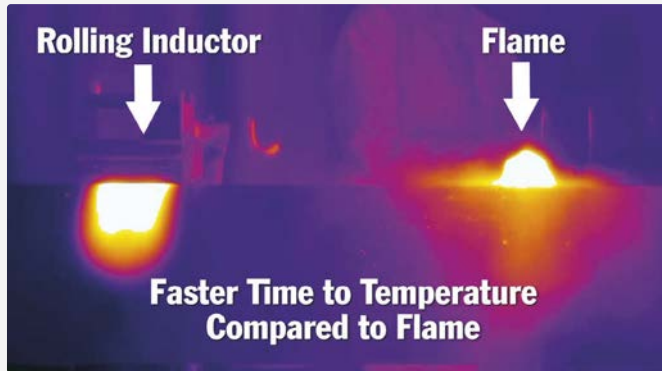

**Induction heating solves many key issues in today's environment.**

- Does not produce the exposure to burns associated with open flames and electrical resistance wires (only the workpiece becomes hot)
- No significant expense of fuel gases
- Produces less particulate from overheated insulation caused by high-temperature electrical wires and ceramic pads

**Induction heating applications:**

- Process piping
- Refinery
- Petrochemical
- Power piping
- Pressure vessels
- Structural
- Shipbuilding
- Pipeline



**For more information:**  
Call **1-844-IND-HEAT (1-844-463-4328)**  
or email [InductionSales@MillerWelds.com](mailto:InductionSales@MillerWelds.com)

## ProHeat 35 Power Source

The ProHeat 35 induction power source is equipped with a built-in temperature controller allowing for manual or temperature-based programming using up to four control thermocouples. At more than 90 percent efficiency, the ProHeat 35 power source transfers more energy to the part, reducing operating costs over different heating methods.

### Digital Recorder (optional)

The digital recorder is commonly used in stress relieving and critical preheat applications. The recorder stores temperature data based on time. It is not required to perform successful heating applications.

### Heavy-Duty Induction Cooler (optional)

Optimized for induction heating applications, cooler features a 2.5-gallon rustproof polyethylene tank, high-pressure pump, and blower to yield a high cooling capacity.



*ProHeat 35 power source shown with optional heavy-duty induction cooler, running gear and digital recorder.*

*Note: Primary input cable is not included with power source.*

## One ProHeat™ System – Four Basic Induction Heating Configurations

ProHeat 35 induction heating systems solve preheating, post weld heat treatment (PWHT) and stress relieving problems.

### Liquid-Cooled Cables See literature IN/15.0

**Preheat applications up to 1,450 degrees Fahrenheit (788°C).**

- A highly versatile tool for preheating, stress relieving, hydrogen bakeout, post weld heat treatment and shrink fit in a variety of pipe diameters and flat plate
- Designed with flexibility in mind, the ProHeat liquid-cooled induction heating cables can be wrapped into coils of various shapes and sizes to fit almost any induction heating application



### Liquid-Cooled Rolling See literature IN/13.0

**Preheat of moving parts up to 600 degrees Fahrenheit (315°C).**

- Ideal for preheating rolling pipe and moving parts, with easy and time-saving setup and movement for maintaining and adhering to preheat and interpass temperatures
- Enables the benefits of rolled pipe welding while also addressing some of the concerns associated with other popular heating methods, such as open flame and resistance heating
- *Optional* infrared temperature sensor can read the temperature on the moving part from 212–750 degrees Fahrenheit (100–400°C)
- *Optional* travel detect system can be used for setting different heating rates/ramps based on workpiece speed travel – when no movement is detected the system turns off the output preventing damage to workpiece and rolling inductor



### Air-Cooled Blankets See literature IN/14.0

**Preheating applications up to 400 degrees Fahrenheit (204°C).**

- Air-cooled blankets are available for pipe diameters from 8–60 inches (20–152 cm) or in the case of plate, the lengths are 41–205 inches (1–5.2 m)
- The blankets easily conform to circular and flat parts and install in a matter of seconds
- Manufactured from durable high-temperature materials, flexible induction blankets are designed to withstand the tough conditions in both industrial and construction applications



### Air-Cooled Cables See literature IN/14.0

**Preheating applications up to 392 degrees Fahrenheit (200°C).**

- Air-cooled cables are available in lengths of 30 foot (9.1 m), 50 foot (15.2 m) or 80 foot (24.4 m) for flexible configurations
- Designed with flexibility and efficiency in mind, the air-cooled cables can be wrapped into coils of various shapes and sizes to fit almost any induction preheating application, without the need for cooler and coolant
- Air-cooled cables provide the same flexibility as liquid-cooled cables for preheating





## ArcReach® Heater Air-Cooled Induction System

See literature IN/16.0

Field preheat and bakeout applications up to 600 degrees Fahrenheit (315°C).



ArcReach Heater

**NEW!**



Air-cooled cable

Air-cooled quick wrap

**ArcReach Heater systems allow economical insured weld preheating and bakeout.** The induction heating tools (air-cooled cables or air-cooled quick wraps) connect to the ArcReach Heater, which is powered by select on-site welding power sources. With ArcReach Heater systems you can:

- Eliminate the costly overruns common with heating contractors
- Eliminate delays due to transitions between heating and welding crews
- Run your own schedule without depending on third-party contractors
- Use existing on-site welding equipment up to 200 feet away as the heating power source
- Lower preheating and bakeout costs
- Automatically and accurately document joint temperatures
- Eliminate safety concerns caused by traditional resistance and open-flame heating

**Easy setup** with flexibility to fit a variety of pipe diameters, plates or odd geometries.

**Time-to-temperature** is faster than conventional processes due to the method of applying heat, reducing cycle time.

**Uniform heating** is maintained along and through the heat zone by using induction heat within the material. The surface of the part is not marred by localized conducted heat at higher than specified temperatures.

**Improved working environment** during welding. Welders are not exposed to open flames, explosive gases and hot elements associated with fuel gas heating and resistance heating.

**ArcReach Heater** is equipped with built-in temperature control allowing for either manual or computer-loaded programming using up to six thermocouples. It can run either one or two heating tools (air-cooled cable or air-cooled quick wrap) at the same time. Requires ArcReach Heater extension cable to operate.

**Air-cooled cables** are designed with flexibility and efficiency in mind. Cables can be wrapped into coils of various shapes and sizes to fit any induction preheat or bakeout application (flat plate, pipe, odd geometries).

**Air-cooled quick wraps** provide a fast and easy way to wrap a pipe joint (up to 10-inch diameter) for preheat and bakeout. Simply place around the pipe, connect the ends, and cinch the clip as close to the pipe as possible.

**Durable high-temperature materials.** Air-cooled cables and quick wraps are designed to withstand the tough conditions in both industrial and construction applications.

**Preheat and bakeout programs** can be manually entered or loaded via USB drive.

**Heating data is automatically recorded** and can be used in quality control and documentation needs.

### Industrial ●

#### Process

- Induction heating

#### Suggested power sources

- XMT® 350 FieldPro (pg 44)
- Trailblazer® Series (ArcReach models only) (pg 78)
- Big Blue® Series (ArcReach models only) (pg 81-84)

#### Most popular accessories



- **ArcReach Heater Extension Cable** 301451 10 ft. (3 m)
- **Air-Cooled Quick Wrap** 301452
- **Air-Cooled Cable** 301453030 30 ft. (9.1 m) 301453050 50 ft. (15.2 m) 301453080 80 ft. (24.4 m)
- **Cable Cover** 204611 30 ft. (9.1 m) 204614 50 ft. (15.2 m) 204620 80 ft. (24.4 m)



- **Preheat Insulation** 204669 1/2 x 6 x 120 in. (1.3 x 15 x 305 cm) 195376 1/2 x 6 x 240 in. (1.3 x 15 x 305 cm) 211474 1/2 x 12 x 120 in. (1.3 x 31 x 305 cm)



- **Preheat Insulation w/ Cable Harness** 301334 1/2 x 16 x 120 in. (1.3 x 41 x 305 cm)
- Series Cable Adapter 195437
- High-Temperature Rope 194965
- Temperature Measurement (two options available) Contact Thermocouple Sensor (Probe) 301517 **OR** welded on thermocouples which requires 500 ft. (152 m) Thermocouple Wire 194999, Thermocouple Connectors (10 pack) 195098, and Thermocouple Attachment Unit 194959

Visit [MillerWelds.com](http://MillerWelds.com) for more information selecting Miller® induction heating options and accessories.

| Stock Number   | Input Power   | Output Current | Output Voltage | Source Current | Output Frequency | Rated Output              | Heater Dimensions   | Heater Net Weight |
|--|---|----------------|----------------|----------------|------------------|---------------------------|---|-------------------|
| (301390) Heater only (requires ArcReach Heater extension cable to operate) | Operates on open-circuit voltage: 50-70 V provided by an XMT 350 FieldPro or ArcReach-equipped engine drive | 200 A          | 300 V          | 33 A           | 5-30 kHz         | 7.8 kW at 100% duty cycle | H: 18.6 in (472 mm)<br>W: 11.2 in (285 mm)<br>D: 26.7 in (678 mm) | 43 lb. (20 kg)    |
| (951848) Heater w/extension cable  |   |                |                |                |                  |                           |   |                   |
| (951849) Heater w/extension cable and two air-cooled quick wraps           |   |                |                |                |                  |                           |   |                   |



For more detailed information, visit

MillerWelds.com/plasmacutters

# Plasma Cutters



## Product Guide

|                                 | Page | Class | Gouging | Piercing | Rated Output/<br>Duty Cycle  | Rated Cutting Thickness* |                 |          | Max. Sever<br>Thickness<br>Mild Steel | Special Features   | Typical Applications   |
|---------------------------------|------|-------|---------|----------|--|--------------------------|-----------------|----------|---------------------------------------|--|--|
|                                 |      |       |         |          |  | Mild Steel               | Stainless Steel | Aluminum |                                       |  |  |
| <b>Spectrum® 375 X-TREME™</b>   | 94   | ●     | ●       | ●        | 30 A at 40%  | 3/8 in.                  | 3/8 in.         | 1/4 in.  | 5/8 in.                               | Auto-Line™ (120-240 V), MVP™ plugs, Auto-Refire™, automatic air regulation, only 19 lb., XT30 torch    | HVAC, maintenance, light construction, hobbyist, auto restoration, fabrication |
| <b>Spectrum® 625 X-TREME™</b>   | 94   | ●     | ●       | ●        | 40 A at 60%  | 5/8 in.                  | 1/2 in.         | 3/8 in.  | 7/8 in.                               | Auto-Line™ (120-240 V), MVP™ adapters, Auto-Refire™, automatic air regulation, only 21 lb., XT40 torch | Maintenance, light construction, body shops, prototyping                       |
| <b>Spectrum® 875</b>            | 94   | ●     | ●       | ●        | 60 A at 50%  | 7/8 in.                  | 7/8 in.         | 5/8 in.  | 1-1/4 in.                             | Auto-Refire™, automatic air regulation, only 49 lb., XT60 or XT60M torch                               | Construction, maintenance/repair, fabrication                                  |
| <b>Spectrum® 875 Auto-Line™</b> | 94   | ●     | ●       | ●        | 208: 60 A at 40%<br>230-380 V: 60 A at 50%<br>380-575 V: 60 A at 60% | 7/8 in.                  | 7/8 in.         | 5/8 in.  | 1-1/4 in.                             | Auto-Line™ (208-575 V), Auto-Refire™, automatic air regulation, only 54 lb., XT60 or XT60M torch       | Construction, maintenance/repair, fabrication                                  |

1-Phase

1 & 3-Ph

| Engine-Driven<br>Welder/Generator                       | Continuous<br>Generator Power                  | Spectrum 375 X-TREME<br>Steel Cut / Output Amp Setting** | Spectrum 625 X-TREME<br>Steel Cut / Output Amp Setting** | Spectrum 875 / 875 Auto-Line<br>Steel Cut / Output Amp Setting** |
|---|--|--|--|--|
| <b>Fusion 160 and Blue Star® 185</b>                    | 6,200 watts                                    | 3/8 in. / 30 A   | Not recommended  | Not recommended  |
| <b>Bobcat™ 200 Air Pak™</b>                             | 6,500 watts                                    | 3/8 in. / 30 A   | Not recommended  | Not recommended  |
| <b>Bobcat™ 225, 260, 3 Phase</b>                        | 9,500 watts                                    | 3/8 in. / 30 A   | 5/8 in. / 40 A   | 1/2 in. / 45 A   |
| <b>Trailblazer® Series</b>                              | 10,500 watts                                   | 3/8 in. / 30 A   | 5/8 in. / 40 A   | 1/2 in. / 45 A   |
| <b>Big Blue® 400 Pro, 400 PipePro® and 450 Duo CST™</b> | 10,000 watts                                   | 3/8 in. / 30 A   | 5/8 in. / 40 A   | 1/2 in. / 45 A   |
| <b>Big Blue® 500 Pro, 600 Series and 800 Series</b>     | 1-phase: 12,000 watts<br>3-phase: 20,000 watts | 3/8 in. / 30 A   | 5/8 in. / 40 A   | 7/8 in. / 50 A   |

Cutting w/ Engine Drive

**\*Note on cut capacity ratings:** The Spectrum Series rating system is designed to provide a guide to help our customers choose the right machine for their application. Rated cut capacity is based on traveling approximately 15 inches per minute to achieve a steady, precise cut. This is the key rating that should meet or exceed your typical cutting thickness requirements. Sever cut is the maximum cut achieved in ideal conditions. Some factors that dictate actual cut speeds, thickness capacity and duty cycles are: types of thermally conductive material being cut, available input power, output power settings and operator technique. For highly thermal conductive metals such as aluminum, cutting capacities may be reduced up to 30 percent compared to mild steel.

**Product Key** Class: ● Light industrial ● Industrial ● Heavy industrial Capability: ● Designed for this process ● Capable of this process

\*See note on cut capacity ratings above. \*\*240 V, full KVA plug. Derate cut capacity with less generator power.

For more detailed information, see individual literature sheets.

## Spectrum® Series Plasma Cutters

Our Spectrum line of plasma cutters provides big cutting power in portable packages and with features like flexible cables and Auto-Refire technology they are better than ever. Step up to Spectrum 625 X-TREME™ or 875/875 Auto-Line™ models to add Ultra-Quick Connect hand-held torches. Machine torch capabilities are available with Spectrum 875/875 Auto-Line™ models only.



Spectrum 375 X-TREME

Spectrum 625 X-TREME

Spectrum 875

Spectrum 875 Auto-Line

### Spectrum Features

| Feature  | 375 X-TREME | 625 X-TREME | 875 | 875 Auto-Line |
|--|-------------|-------------|-----|---------------|
| Auto-Line (120-240 V)                          | ●           | ●           |     | ●             |
| Auto-Line (208-575 V)                          | ●           | ●           |     | ●             |
| MVP™ plugs/adapters                            | ●           | ●           |     | ●             |
| Ultra-Quick Connect™ torch with flexible cable |             |             | ●   | ●             |
| Quick connect flexible work cable with clamp   | ●           | ●           | ●   | ●             |
| Built-in gas/air filter and regulator          | ●           | ●           | ●   | ●             |
| Auto-Refire™                                   | ●           | ●           | ●   | ●             |
| Auto postflow                                  | ●           | ●           | ●   | ●             |
| Auto air regulation                            | ●           | ●           | ●   | ●             |
| X-CASE™  | ●           | ●           |     |               |
| Machine torch capable                          |             |             | ●   | ●             |

### Steel/Stainless/Aluminum Rated Cutting Capacity

| Material        | Spectrum 375 X-TREME |                    |                   | Spectrum 625 X-TREME |                    |                   | Spectrum 875/875 Auto-Line |                   |                   |
|-----------------|----------------------|--------------------|-------------------|----------------------|--------------------|-------------------|----------------------------|-------------------|-------------------|
|                 | 12 ft. (3.7 m)       | 20 ft. (6.1 m)     | 50 ft. (15.2 m)   | 12 ft. (3.7 m)       | 20 ft. (6.1 m)     | 50 ft. (15.2 m)   | 12 ft. (3.7 m)             | 20 ft. (6.1 m)    | 50 ft. (15.2 m)   |
| Steel/Stainless | 3/8 in. (9.5 mm)     | 5/8 in. (15.9 mm)* | 7/8 in. (22.2 mm) | 3/8 in. (9.5 mm)     | 5/8 in. (15.9 mm)* | 7/8 in. (22.2 mm) | 3/8 in. (9.5 mm)           | 5/8 in. (15.9 mm) | 7/8 in. (22.2 mm) |
| Aluminum        | 1/4 in. (6.4 mm)     | 3/8 in. (9.5 mm)   | 5/8 in. (15.9 mm) | 1/4 in. (6.4 mm)     | 3/8 in. (9.5 mm)   | 5/8 in. (15.9 mm) | 1/4 in. (6.4 mm)           | 3/8 in. (9.5 mm)  | 5/8 in. (15.9 mm) |

\*Stainless: 1/2 in. (12.7 mm) for Spectrum 625 X-TREME.

Cut capacity ratings are based on traveling speed of approximately 15 inches per minute to achieve a precise cut. This is the key rating that should meet or exceed your typical cutting thickness requirements. Factors that can affect actual cut speeds, thickness capacity and duty cycles are: types of thermally conductive material being cut, available input power, output power settings and operator technique. For highly thermal conductive metals such as aluminum, cutting capacities may be reduced up to 30 percent compared to mild steel.

**Power factor correction (PFC).** Uses less energy by utilizing input power more efficiently.

**LED indicators for easy troubleshooting.**

**Non-high-frequency arc starting** does not interfere with or damage controls or computers.

**Postflow cooling circuitry** extends life of the consumable and torch by cooling them with postflow air after trigger is released.

**Auto-Refire™** provides ultimate convenience by automatically controlling the pilot arc when cutting expanded metal or multiple pieces of metal.

**Automatic air regulation** compensates for input pressure variation to provide constant recommended torch pressure for optimal cutting performance.

**Built-in gas/air filter and regulator.** Provides air filtration of airborne particles five microns and larger. Additional filtration and water separation recommended.

**LVC™ line voltage compensation** provides peak performance power under variable input voltage conditions for clean, steady cuts.

**Wind Tunnel Technology™** prevents abrasive dust and particles from damaging internal components.

**Fan-On-Demand™** cooling system only operates when needed, reducing power consumption and keeping internal components cleaner.

**Quick connect flexible work cable with heavy-duty clamp.**

### Spectrum 625 X-TREME and 875/875 Auto-Line hand-held torches



**Ultra-Quick Connect™ hand-held torches with flexible cables.**

XT40 hand-held torch for Spectrum 625 X-TREME and XT60 hand-held torch for both Spectrum 875 models

feature quick torch connection, ergonomic handles to help prevent operator fatigue and flexible cables that make maneuvering easier.

### Spectrum 875/875 Auto-Line machine torches



**Long and short body machine torches.**

XT60M machine torches for both Spectrum 875 models come in long or short body configurations in either 25- or 50-foot cable lengths. Only long body torches are available in packages, but both bodies can be ordered separately (see page 122).

### Models/packages

Spectrum 375 X-TREME hand-held torch package shown.

Spectrum 875 Auto-Line long body machine torch package shown.



| Model                  | Hand-Held Torch Packages |                |                 | Long Body Machine Torch Packages |                 |
|------------------------|--------------------------|----------------|-----------------|----------------------------------|-----------------|
|                        | 12 ft. (3.7 m)           | 20 ft. (6.1 m) | 50 ft. (15.2 m) | 25 ft. (7.6 m)                   | 50 ft. (15.2 m) |
| Spectrum 375 X-TREME   | (907529)                 | —              | —               | —                                | —               |
| Spectrum 625 X-TREME   | (907579)                 | (907579001)    | —               | —                                | —               |
| Spectrum 875           | —                        | (907583)       | (907583001)     | (907583002)                      | —               |
| Spectrum 875 Auto-Line | —                        | (907584)       | (907584001)     | (907584002)                      | (907584004)     |

## Spectrum® 375 X-TREME™/625 X-TREME™

See literature PC/9.2 (375 X-TREME) and PC/9.6 (625 X-TREME)

**AUTO-LINE TECHNOLOGY** Allows for any input voltage hookup (120-240 V, single-phase, 50/60 Hz for 375 X-TREME and 60 Hz for 625 X-TREME) with no manual linking, providing convenience in any job setting.

**X-CASE™** provides the ultimate protection during transport and storage. Additional space is ideal for MVP plugs, consumables box, gloves, etc.

**Multi-voltage plug (MVP™) on 375 X-TREME or MVP™ adapter on 625 X-TREME** allows connection to 120- or 240-volt receptacles without tools.

**Automatic gouging consumable detection (625 X-TREME only).** Detects gouging consumable and adjusts gas pressure to optimize performance, eliminating the need for a manual regulator.



Spectrum 625 X-TREME shown

**375 X-TREME model includes XT30 hand-held torch** with ergonomic design and flexible cable.

**625 X-TREME model includes Ultra-Quick Connect™ XT40 hand-held torch** with ergonomic design and flexible cable.

## Spectrum® 875/875 Auto-Line™

See literature PC/9.8

**AUTO-LINE TECHNOLOGY** Spectrum 875 Auto-Line model allows for any input voltage hookup (208-575 V, single- or three-phase) with no manual linking, providing convenience in any job setting. *Standard Spectrum 875 model operates on 208/230 V, single-phase input voltage only.*

**Consumables storage compartment** provides convenient access to consumables and parts.

**Machine torch capable.** Both Spectrum 875 models can be ordered with a long body machine torch or can be converted to use a machine torch with optional automation kits. Machine torches are NOT included in automation kits and must be ordered separately (see page 122).

Spectrum 875 shown



**Includes Ultra-Quick Connect™ XT60 hand-held torch** with ergonomic design and flexible cable or **XT60M long body machine torch.**

**Light industrial** ● 375/625 models  
**Industrial** ● 875 models

**DC 3 1** Only 875 Auto-Line has 3-phase capabilities.

### Processes

- Air plasma cutting
- Air plasma gouging (625/875 models)

### 375 X-TREME package comes complete with

- XT30 hand-held torch with 12 ft. (3.7 m) cable
- Heavy-duty work clamp with 12 ft. (3.7 m) flexible cable
- 10 ft. (3 m) power cord with MVP 5-15P (120 V, 15 A) and 6-50P (240 V, 50 A) plugs
- X-CASE for protection and storage
- Shoulder strap
- Consumables box with two electrodes, two tips, deflector and air fitting

### 625 X-TREME packages come complete with

- XT40 hand-held torch with 12 ft. (3.7 m) or 20 ft. (6.1 m) cable
- Heavy-duty work clamp and flexible cable with quick connect
- 12 ft. (3.7 m) power cord with 240 V, L6-30P twist lock plug
- MVP adapters with 5-15P (120 V, 15 A) and 6-50P (240 V, 50 A) plugs
- X-CASE for protection and storage
- Shoulder strap
- Consumables box with two electrodes, two 40 A tips, one 30 A tip, one 30 A drag shield, deflector and air fitting

### 875 and 875 Auto-Line packages come complete with

- XT60 hand-held torch with 20 ft. (6 m) or 50 ft. (15.2 m) cable **OR** XT60M long body machine torch with 25 ft. (7.6 m) or 50 ft. (15.2 m) cable
- Heavy-duty work clamp and flexible cable with quick connect
- 10 ft. (3 m) power cord
- Extra consumables
- Machine torch packages include corresponding automation kit

### Most popular accessories

- Automation Kits for Spectrum 875 models (pg 122)
- Cables and Cable Covers (pg 122)
- Cutting Guides (pg 122)
- Filters (pg 122)
- Plugs and Cords (pg 122)
- X-CASE (pg 122)
- Torches (pg 122)
- Torch Consumables (pg 122)

Visit [MillerWelds.com](http://MillerWelds.com) or your distributor for other Miller® options and accessories.

| Model  | Input Power  | Rated Output at 104°F (40°C)                 | Amps Input at Rated Output | KVA | KW  | Compressor Requirement                             | Dimensions   | Net Weight with Torch   |
|--|--------------|--|----------------------------|-----|-----|--|--|---|
| Spectrum 375 X-TREME<br>120-240 V,<br>50/60 Hz   | Single-phase | 120 V (15 A): 20 A at 88 VDC, 60% duty cycle | 18.3                       | 2.1 | 2.1 | 5.0 cfm<br>(142 L/min.)<br>at 90 psi<br>(621 kPa)  | H: 9 in. (229 mm)<br>W: 5.5 in. (140 mm)<br>D: 13.25 in. (337 mm)    | 12 ft. torch:<br>19 lb. (8.6 kg)  |
|  |              | 120 V (20 A): 27 A at 92 VDC, 35% duty cycle | 26.1                       | 3.1 | 3.1 |  |  |   |
|  |              | 240 V: 30 A at 92 VDC, 40% duty cycle        | 14.7                       | 3.5 | 3.4 |  |  |   |
| Spectrum 625 X-TREME<br>120-240 V,<br>60 Hz      | Single-phase | 120 V (15 A): 20 A at 88 VDC, 60% duty cycle | 17.7                       | 2.1 | 2.1 | 6.0 cfm<br>(170 L/min.)<br>at 90 psi<br>(621 kPa)  | H: 9 in. (229 mm)<br>W: 5.5 in. (140 mm)<br>D: 13.25 in. (337 mm)    | 12 ft. torch:<br>21 lb. (9.5 kg)<br>20 ft. torch:<br>23 lb. (10.5 kg)                                       |
|  |              | 120 V (20 A): 27 A at 91 VDC, 35% duty cycle | 25.0                       | 3.0 | 3.0 |  |  |   |
|  |              | 240 V: 40 A at 140 VDC, 60% duty cycle       | 27.6                       | 6.6 | 6.5 |  |  |   |
| Spectrum 875<br>208/230 V,<br>50/60 Hz           | Single-phase | 208 V: 60 A at 140 VDC, 40% duty cycle       | 208 V: 47                  | 9.9 | 9.8 | 6.75 cfm<br>(191 L/min.)<br>at 90 psi<br>(621 kPa) | H: 13.5 in. (343 mm)<br>W: 8.75 in. (222 mm)<br>D: 18.5 in. (470 mm) | 20 ft. torch:<br>49 lb. (22.2 kg)<br>25 ft. torch:<br>51 lb. (23.1 kg)<br>50 ft. torch:<br>58 lb. (26.3 kg) |
|  |              | 230 V: 60 A at 140 VDC, 50% duty cycle       | 230 V: 42                  |     |     |  |  |   |
| Spectrum 875 Auto-Line<br>208-575 V,<br>50/60 Hz | Three-phase  | 208 V: 60 A at 140 VDC, 40% duty cycle       | 208 V: 27.5                | 9.9 | 9.4 | 6.75 cfm<br>(191 L/min.)<br>at 90 psi<br>(621 kPa) | H: 13.5 in. (343 mm)<br>W: 8.75 in. (222 mm)<br>D: 18.5 in. (470 mm) | 20 ft. torch:<br>54 lb. (24.5 kg)<br>25 ft. torch:<br>56 lb. (25.4 kg)<br>50 ft. torch:<br>63 lb. (28.6 kg) |
|  |              | 230-380 V: 60 A at 140 VDC, 50% duty cycle   | 230 V: 25                  |     |     |  |  |   |
|  |              | 380-575 V: 60 A at 140 VDC, 60% duty cycle   | 380 V: 15                  |     |     |  |  |   |
| Spectrum 875 Auto-Line<br>208-575 V,<br>50/60 Hz | Single-phase | 460 V: 12.4                                  | 460 V: 12.4                | 9.9 | 9.7 |  |  |   |
|  |              | 575 V: 9.8                                   | 575 V: 9.8                 |     |     |  |  |   |
| Spectrum 875 Auto-Line<br>208-575 V,<br>50/60 Hz | Single-phase | 208 V: 60 A at 140 VDC, 40% duty cycle       | 208 V: 47.4                | 9.9 | 9.7 |  |  |   |
|  |              | 230 V: 60 A at 140 VDC, 40% duty cycle       | 230 V: 42.2                |     |     |  |  |   |
|  |              | 230 V: 50 A at 140 VDC, 100% duty cycle      |                            |     |     |  |  |   |



Miller offers an extensive line of quality regulators, cutting torches, tips and a variety of accessories for your oxy-fuel cutting and welding requirements.

## Pressure Regulators



Series 40



Series 30

### Heavy-duty and medium-duty single-stage pressure regulators

Series 40™ and Series 30™ industrial-grade pressure regulators provide accurate pressure readings for welding, cutting, heating and other applications. Extremely durable construction and simplified design provide consistent gas flow and longer trouble-free operation. Covered by a three-year warranty.

### Also available

#### Series 30 single-stage regulator twin packs



| Stock Number | Gas          | Regulator  | Max. Delivery Pressure or Flow | Inlet Connection |
|--------------|--------------|------------|--------------------------------|------------------|
| HTP2         | Oxygen       | 30-100-540 | 100 psig (7 bar)               | CGA 540          |
|              | LP Acetylene | 30-15-510  | 15 psig (1 bar)                | CGA 510          |
| HTP5         | Oxygen       | 30-100-540 | 100 psig (7 bar)               | CGA 540          |
|              | Acetylene    | 30-15-300  | 15 psig (1 bar)                | CGA 300          |



### Medium-duty two-stage pressure regulators

Series 35™ two-stage regulators drop cylinder pressure to working pressure in two stages for consistent and accurate outlet pressure and flow regardless of inlet pressure. Recommended where outlet pressure and flow must be maintained without variation. Covered by a three-year warranty.



### Heavy-duty single-stage station regulators

Series 46™ brass line regulators are rugged, accurate and corrosion resistant. Station regulators are used to connect pipeline gas delivery systems to the welding stations. Because the pipeline pressure is regulated upstream, station regulators only require a single delivery pressure gauge. Covered by a three-year warranty.

\*In the chart below, oxygen "C" size inlet connection CGA 024 (7/8"-14 RH) fits station valve Rego. No. 7160. Fuel gases "C" size inlet connection CGA 025 (7/8"-14 LH) fits station valve Rego. No. 7161.  
Note: Body inlet is 1/4-inch (6 mm) NPT.

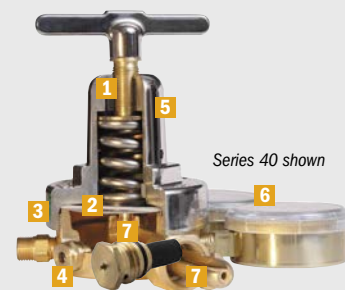

Series 40 shown

Sure Seat filtered high-pressure seat assembly

### Features

- 1 Resin bonnet insert (Series 40/46 only)**  
Allows smooth, easy adjustment even at high-pressure levels.
- 2 Stainless steel diaphragm**  
Resists corrosion, leaking and freeze-up if used with liquid (cryogenic) gases for extended service life.  
*Note: Series 30 has neoprene composite diaphragm.*
- 3 Color-coded labels**  
Supplies performance capabilities, easy gas service identification and technical information.
- 4 External relief valve**  
Protects regulator from damage due to inadvertent high-pressure surge. Relief valve will release excessive pressure and automatically reset.
- 5 Nickel-plated bonnet**  
Along with brass body, protects regulator against corrosion.
- 6 Gauges and lenses**  
2.5-inch corrosion-resistant polished brass gauges with shatter-resistant polycarbonate lenses.  
*Note: Series 30 has 2-inch painted steel gauges.*
- 7 Sure Seat™ dual-filtered seat assembly**  
Protects high-pressure seat from debris for reliable operation and long service life.

| Model  | Stock Number | Gas             | Max. Delivery Pressure | Max. Inlet Pressure  | Outlet Connection   | Inlet Connection |
|--|--------------|-----------------|------------------------|----------------------|---------------------|------------------|
| Heavy-Duty Series 40 Single-Stage Pressure Regulators  | 40-175-540   | Oxygen          | 175 psig (12 bar)      | 3,000 psig (207 bar) | 9/16"-18 RH         | CGA 540          |
|  | 40-275-540   | Oxygen          | 275 psig (19 bar)      | 3,000 psig (207 bar) | 9/16"-18 RH         | CGA 540          |
|  | 40-15-510    | Acetylene       | 15 psig (1 bar)        | 400 psig (28 bar)    | 9/16"-18 LH         | CGA 510          |
|  | 40-15-300    | Acetylene       | 15 psig (1 bar)        | 400 psig (28 bar)    | 9/16"-18 LH         | CGA 300          |
|  | 40-50-510    | LP gas          | 50 psig (3 bar)        | 400 psig (28 bar)    | 9/16"-18 LH         | CGA 510          |
|  | 40-275-580   | Inert gas       | 275 psig (19 bar)      | 3,000 psig (207 bar) | 5/8"-18 RH internal | CGA 580          |
| Medium-Duty Series 30 Single-Stage Pressure Regulators | 30-100-540   | Oxygen          | 100 psig (7 bar)       | 3,000 psig (207 bar) | 9/16"-18 RH         | CGA 540          |
|  | 30-20-540    | Oxygen          | 20 psig (1.4 bar)      | 3,000 psig (207 bar) | 9/16"-18 RH         | CGA 540          |
|  | 30-15-510    | Acetylene       | 15 psig (1 bar)        | 400 psig (28 bar)    | 9/16"-18 LH         | CGA 510          |
|  | 30-15-300    | Acetylene       | 15 psig (1 bar)        | 400 psig (28 bar)    | 9/16"-18 LH         | CGA 300          |
|  | 30-15-520    | Acetylene       | 15 psig (1 bar)        | 400 psig (28 bar)    | 9/16"-18 LH         | CGA 520          |
|  | 30-15-200    | Acetylene       | 15 psig (1 bar)        | 400 psig (28 bar)    | 9/16"-18 LH         | CGA 200          |
|  | 30-50-510    | LP gas          | 50 psig (3 bar)        | 400 psig (28 bar)    | 9/16"-18 LH         | CGA 510          |
|  | 30-150-580   | Inert gas       | 150 psig (10 bar)      | 3,000 psig (207 bar) | 5/8"-18 RH internal | CGA 580          |
|  | 30-150-320   | CO <sub>2</sub> | 150 psig (10 bar)      | 3,000 psig (207 bar) | 5/8"-18 RH internal | CGA 320          |
|  | 30-100-350   | Hydrogen        | 100 psig (7 bar)       | 3,000 psig (207 bar) | 9/16"-18 LH         | CGA 350          |
| Medium-Duty Series 35 Two-Stage Pressure Regulators    | 35-125-540   | Oxygen          | 125 psig (9 bar)       | 3,000 psig (207 bar) | 9/16"-18 RH "B"     | CGA 540          |
|  | 35-15-510    | Acetylene       | 15 psig (1 bar)        | 400 psig (28 bar)    | 9/16"-18 LH "B"     | CGA 510          |
|  | 35-50-580    | Inert gas       | 50 psig (3 bar)        | 3,000 psig (207 bar) | 5/8"-18 RH internal | CGA 580          |
| Heavy-Duty Series 46 Station Regulators                | 46-175       | Oxygen          | 175 psig (12 bar)      | 200 psig (14 bar)    | 9/16"-18 RH "B"     | CGA 024*         |
|  | 46-15        | Acetylene       | 15 psig (1 bar)        | 200 psig (14 bar)    | 9/16"-18 LH "B"     | CGA 025*         |
|  | 46-50        | LP gas          | 50 psig (3 bar)        | 200 psig (14 bar)    | 9/16"-18 LH "B"     | CGA 025*         |

# Flowmeter and Flow Gauge Regulators

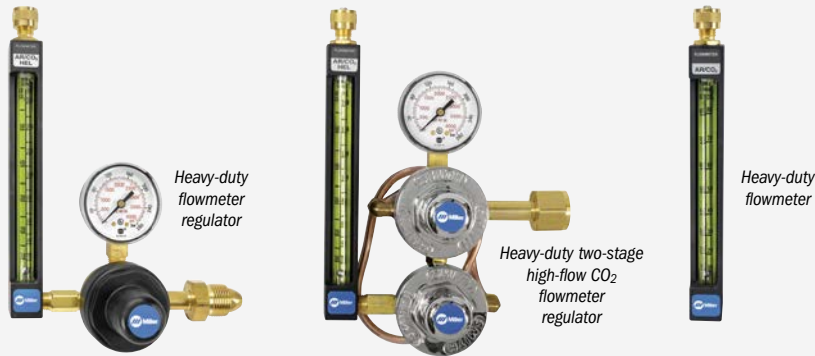

## Heavy-duty flowmeter regulators and flowmeters

Heavy-duty flowmeter regulators and flowmeters feature an exclusive self-centering ball guide which provides accurate readings even if tipped. This ensures optimum weld quality and gas savings. Others use a non-self-centering flow tube ball that tends to float off center causing actual gas flow to be up to two times greater than indicated. Covered by a three-year warranty.

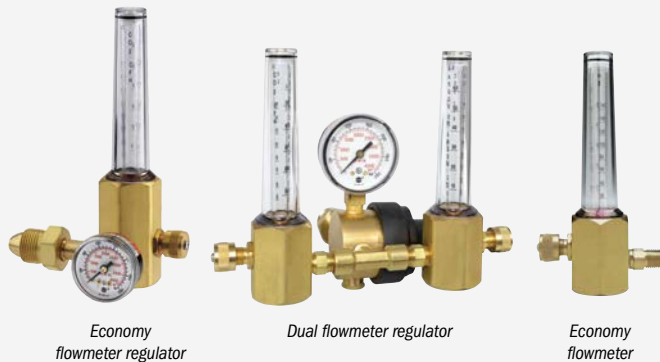

## Economy flowmeter regulators and flowmeters

Economy flowmeter regulators and flowmeters combine exceptional value and a compact design with precise shielding gas regulation for MIG and TIG welding applications and more. Covered by a three-year warranty.



## Single-stage flow gauge regulators

Series 30™ single-stage flow gauge regulators are compact and feature a forged brass body and a self-resetting pressure relief valve. They include a Sure Seat™ protective inlet filter and a durable neoprene-composite diaphragm. Covered by a three-year warranty.

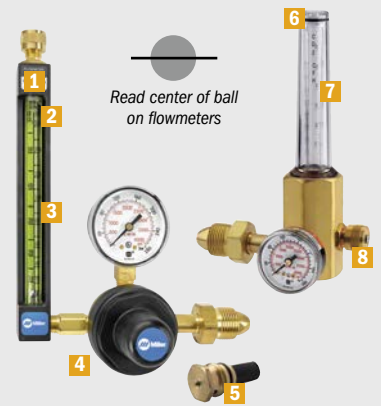

## Heavy-duty model features

- Rugged aluminum protective housing**  
Protects flow tubes from damage while offering unobstructed view of flow reading.
- Extra-long flow tube**  
Expanded scales are easy to read and accurate within five percent of full reading. Can be attached to regulators or pipeline installations.
- Shatter-resistant multi-scale flow tube**  
Made of shatter-resistant polycarbonate resin and features easy-to-read scales for CO<sub>2</sub>, argon, argon/CO<sub>2</sub> mix and helium.
- Auto-reset pressure-relief valve**  
Protects regulator from damage due to high-pressure surge. Relief valve will release excessive pressure and automatically reset.
- Sure Seat™ dual-filtered seat assembly**  
Protects high-pressure seat from debris for reliable operation and long service life.

## Economy model features

- Built-in rupture disc**  
Reduces possibility of flow tube damage due to high-pressure surge. Must be replaced if ruptured – not auto-resetting.
- Shatter-resistant triple-scale flow tube**  
Made of shatter-resistant polycarbonate resin and can be rotated to position desired scale for easy reading. Scaled for CO<sub>2</sub>, argon and argon/CO<sub>2</sub> mix, and helium.
- Precision flow-adjustment valve**  
Allows easy adjustment to desired setting.

| Model   | Stock Number                                    | Gas                             | Flow Range            | Max. Inlet Pressure         | Outlet Connection   | Inlet Connection    |
|---|---|---------------------------------|-----------------------|-----------------------------|---------------------|---------------------|
| Heavy-Duty Flowmeter Regulators               | 22-80-580 Single-stage                          | Argon/CO <sub>2</sub>           | 10-80 scfh (5-38 lpm) | 3,000 psig (207 bar)        | 5/8"-18 RH internal | CGA 580             |
|   | 22-80-580-6 Single-stage w/gas hose             |                                 |                       |                             |                     |                     |
|   | 22-80-320 Single-stage                          | CO <sub>2</sub>                 | 10-80 scfh (5-38 lpm) | 3,000 psig (207 bar)        | 5/8"-18 RH internal | CGA 320             |
|   | 22-80-320-6 Single-stage w/gas hose             |                                 |                       |                             |                     |                     |
|   | 22-30-580 Single-stage                          | Argon/CO <sub>2</sub>           | 10-55 scfh (5-26 lpm) | 3,000 psig (207 bar)        | 5/8"-18 RH internal | CGA 580             |
| 22-30-580-6 Single-stage w/gas hose           |   |                                 |                       |                             |                     |                     |
| 35-30-320 Two-stage high-flow CO <sub>2</sub> | CO <sub>2</sub>                                 | 10-55 scfh (5-26 lpm)           | 3,000 psig (207 bar)  | 5/8"-18 RH internal         | CGA 320             |                     |
| Heavy-Duty Flowmeters                         | 16530 Argon, CO <sub>2</sub>                    | Argon, CO <sub>2</sub>          | 10-80 scfh (5-38 lpm) | 80 psig (6 bar) recommended | 5/8"-18 RH internal | 1/4" NPT female     |
|   | 16531 Argon, CO <sub>2</sub> , helium           | Argon, CO <sub>2</sub> , helium | Depends on gas        | 30 psig (2 bar) recommended |                     |                     |
| Economy Flowmeter Regulators                  | H2051B-580 Single-stage                         | Argon                           | 0-60 scfh (0-28 lpm)  | 3,000 psig (207 bar)        | 5/8"-18 RH internal | CGA 580             |
|   | H2051B-580H Single-stage w/gas hose             | CO <sub>2</sub>                 | 0-50 scfh (0-24 lpm)  | 3,000 psig (207 bar)        |                     |                     |
|   | 23-50-580 Single-stage dual flowmeter regulator | Helium                          | 0-160 scfh (0-78 lpm) | 3,000 psig (207 bar)        |                     |                     |
| Economy Flowmeters                            | H2230A Multi-scale                              | Argon, helium, CO <sub>2</sub>  | Depends on gas        | 50 psig (3 bar) recommended | 5/8"-18 RH internal | 1/4" NPT male       |
|   | H2231A Multi-scale                              |                                 |                       |                             |                     | 5/8"-18 RH external |
| Single-Stage Series 30 Flow Gauge Regulators  | 31-50-580 Single-stage                          | Argon                           | 0-50 scfh (0-24 lpm)  | 3,000 psig (207 bar)        | 5/8"-18 RH internal | CGA 580             |
|   | 31-50-580-6 Single-stage w/gas hose             |                                 |                       |                             |                     |                     |
|   | 31-50-320 Single-stage                          | CO <sub>2</sub>                 | 0-50 scfh (0-24 lpm)  | 3,000 psig (207 bar)        | 5/8"-18 RH internal | CGA 320             |

# Specialty Regulators



## HVAC/refrigeration purge/leak test regulator

Single-stage nitrogen regulator is specially designed to meet the specifications of HVAC refrigerant-purging applications. This regulator is used with nitrogen to test HVAC systems to locate leaks and to purge an area for installation and repair. It is economical, accurate and its compact size is useful where space is limited. Covered by a one-year warranty.

- 2-inch (51 mm) gauges with shatter-resistant lenses and solid brass body for durability
- Large durable nylon knob for easy pressure adjustment

| Stock Number | Gas      | Max. Delivery Pressure | Max. Inlet Pressure  | Outlet Connection               | Inlet Connection |
|--------------|----------|------------------------|----------------------|---------------------------------|------------------|
| 30-450-580   | Nitrogen | 450 psig (31 bar)      | 3,000 psig (207 bar) | 7/16"-20 external flair fitting | CGA 580          |



## Heavy-duty high-pressure regulator

820 Series regulators are for use on cylinders with a wide variety of non-corrosive inert gases. Typical applications include high-pressure testing, purging/charging, calibration kits, airline charging carts, chemical plants, manufacturing processes, research/development and laboratories. Covered by a two-year warranty.

- Piston-sensor design gives structural reliability in high-pressure use
- Low-torque-control adjusting screw for easy pressure adjustments in closed/dead end systems
- Due to specific configurations, we cannot accept returns of 820 Series regulators

| Model Series | Max. Delivery Pressure | Max. Inlet Pressure | Option 1 - Outlet pressure | Model Configuration                           | Option 3 Inlet connection (additional inlet connections available)/Max. inlet pressure |
|--------------|------------------------|---------------------|----------------------------|---|--|
| 823          | 500 psig               | 6,000 psig          | 823 0-500 psig             | 825 - 66 26                                   | 00 1/4" FNPT   |
| 824          | 1,000 psig             |                     | 824 0-1,000 psig           | Option 2 Outlet connection                    | 08 CGA 540 (oxygen) 3,000 psig   |
| 825          | 2,000 psig             |                     | 825 0-2,000 psig           | 00 1/4" FNPT                                  | 09 CGA 580 (inert) 3,000 psig  |
| 826          | 4,000 psig             |                     | 826 0-4,000 psig           | 66 Stainless steel needle valve with 1/4" NPT | 26 CGA 347 stainless steel 5,500 psig  |
| 827          | 6,000 psig             |                     | 827 0-6,000 psig           |   | 27 CGA 677 stainless steel 7,500 psig  |
|              |                        |                     |                            |   | 28 CGA 680 stainless steel 5,500 psig  |



## Rear-entry liquid cylinder regulator

250 Series regulators are ideal for non-corrosive high-purity applications and have a rear-entry connection that provides clearance of the liquid cylinder ring for easier gauge reading. Covered by a two-year warranty.

- Easy-to-read single-scale 2.5-inch (64 mm) gauge with shatter-resistant lens
- Nickel-plated brass body for corrosion resistance
- Large 1.875-inch stainless steel diaphragm for precise control of pressure
- Large durable nylon knob for easy pressure adjustment
- Due to specific configurations, we cannot accept returns of 250 Series regulators

Note: Use Series 40™ heavy-duty regulators constructed with a stainless steel diaphragm for high-volume or liquid (cryogenic) cylinder applications.

| Model Series | Max. Delivery Pressure | Max. Inlet Pressure | Option 1 - Outlet pressure | Model Configuration                  | Option 3 Inlet connection |
|--------------|------------------------|---------------------|----------------------------|--------------------------------------|---------------------------|
| 252          | 100 psig               | 3,500 psig          | 252 0-100 psig             | 252 - 20 08                          | 00 1/4" FNPT              |
| 254          | 200 psig               |                     | 254 0-200 psig             | Option 2 Outlet connection           | 02 CGA 320                |
| 255          | 350 psig               |                     | 255 0-350 psig             | 00 1/4" FNPT                         | 08 CGA 540                |
| 256          | 500 psig               |                     | 256 0-500 psig             | 20 Chrome needle valve with 1/4" NPT | 09 CGA 580                |
|              |                        |                     |                            | 82 9/16"-18 RH "B"                   |                           |

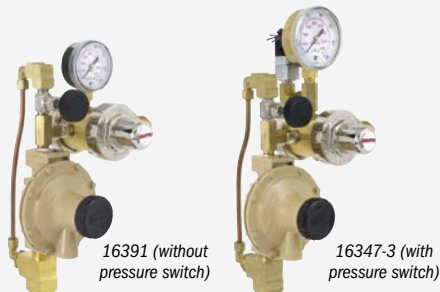

## Three-stage nitrogen low-pressure regulator

Preset regulators are specially designed to deliver a highly accurate and consistent 0.50 psig supply of nitrogen to the head space of oil-filled power transformers. Available with or without electronic pressure switch. Covered by a one-year warranty.

- Built-in self-relieving valve set at 8 psig protects the system from over-pressurization due to temperature variation
- Rapid-fill bypass pressure valve allows rapid filling of the transformer with 6 psig of pressure

Note: Operation temperature: -40° to +180° Fahrenheit. Operation voltage (model 16347-3): 5 amps at 12/24 volts DC or 125 volts AC. 3 amps at 250 volts. Pressure switch setting: Adjustable from 70-300 psig (ships preset at 250 psig), 3/32-inch Allen head screw switch. Switch wiring: Normally open or normally closed (DPDT), three 18-inch flying leads.

| Stock Number                  | Preset Outlet Pressure |                  |  | Bypass Rapid Fill/Purge | Max. Inlet Pressure  | Outlet Connection | Inlet Connection |
|-------------------------------|------------------------|------------------|--|-------------------------|----------------------|-------------------|------------------|
|                               | 1st Stage              | 2nd Stage        | 3rd Stage (delivery pressure)            |                         |                      |                   |                  |
| 16391 without pressure switch | 150 psig (10 bar)      | 8 psig (0.6 bar) | 0.4-0.6 psig (0.03-0.04 bar) into outlet | 6 psig (0.4 bar)        | 3,000 psig (207 bar) | 1/2" FNPT         | CGA 580          |
| 16347-3 with pressure switch  | into 2nd stage         | into 3rd stage   |  |                         |                      |                   |                  |

### Most popular accessories

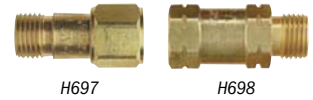

#### Reverse-Flow Check Valve Set (oxy and fuel)

- H697 Torch mount
- H698 Regulator mount



#### Flashback Arrestor Set (oxy and fuel)

- H743 Torch mount
- H753 Regulator mount



#### Fixed-Flow Adapters

H1400 Series fixed-flow adapters are for welding operations requiring fixed-flow gases. Ideal for directly connecting to pipeline outlet. Visit [MillerWelds.com](http://MillerWelds.com) for more information.



#### Surge Protectors

15001 Series surge protectors are for MIG welding applications to help eliminate sudden surges of shielding gas in the wire feeder. Ideal for directly connecting to a welder or wire feeder. Visit [MillerWelds.com](http://MillerWelds.com) for more information.



#### GASAVER™

- WDW100 Propylene/oxygen
- WDW101 Acetylene/oxygen
- WDW103 Propane or natural gas (less than 4 psi)
- WDW104 Propane or natural gas/oxygen (4 psi and above)

- For repetitious brazing and soldering
- Hang torch to shut off
- Pilot light for relighting
- Eliminates flame readjustment

Visit [MillerWelds.com](http://MillerWelds.com) or your distributor for other Miller® options and accessories.

# Torches

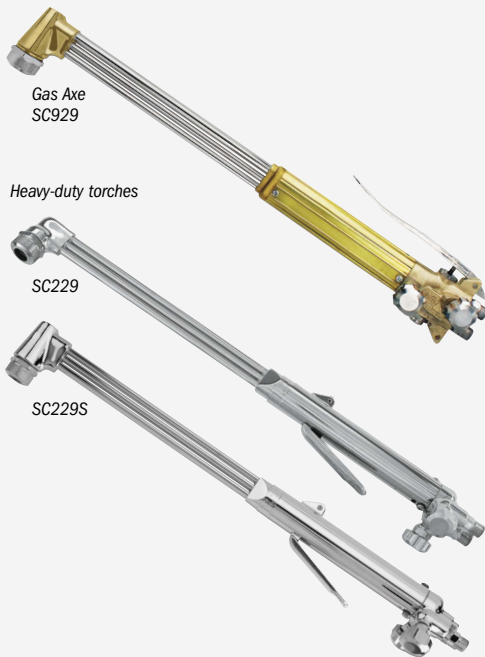

## Cutting torches (acetylene, natural gas, LP or propylene-based fuels)

**Gas Axe™ extra-heavy-duty cutting torches** are ideal for scrap, salvage and demolition cutting.

- Covered by a one-year warranty
- Reversible (top or bottom) mount cutting lever
- Thick-wall forged brass head available in angles from 75 to 180 degrees
- Uses our exclusive long-lasting Graf-Tite® soft-seat cutting tips with in-tip gas mixing for added resistance to flashbacks
- Cuts up to 20 inches (508 mm) with LP and up to 12 inches (305 mm) with acetylene or propylene

**Heavy-duty cutting torches** are ideal for construction, fabrication and shipyard industries.

- Covered by a five-year warranty
- Nickel-plated finish for added corrosion resistance and to reflect residual heat
- Built-in Flo-Trol valve protects the seat from burnout due to reverse flow on low oxygen
- Available in three lengths and three different head angles
- Uses our exclusive long-lasting Graf-Tite® soft-seat cutting tips with in-tip gas mixing for added resistance to flashbacks
- Cuts up to 12 inches (305 mm)



## Combination torches (acetylene, natural gas, LP or propylene-based fuels)

Constructed to last a lifetime for safe performance under rugged conditions. For cutting, heating and welding.

- Covered by a five-year warranty (except Toughcut™ cutting attachment CC509P which has a three-year warranty)
- Built-in Flo-Trol valve protects the seat from burnout due to reverse flow on low oxygen (heavy- and medium-duty torches only)
- Spring-loaded back-pressure check valve is designed to stop common cause of seat burnout
- Ease-on cutting oxygen valve to reduce slag blowback when piercing
- Thick-wall brass head forgings resist warping and distortion
- Uses our exclusive long-lasting Graf-Tite® soft-seat cutting tips with in-tip gas mixing for added resistance to flashbacks
- Heavy-duty torches cut up to 8 inches (203 mm), medium-duty up to 6 inches (152 mm) and standard-duty up to 3 inches (76 mm)



## Machine torches (acetylene, natural gas, LP or propylene-based fuels)

Superior performance with solid construction.

- Covered by a five-year warranty
- Torch barrels are adjustable to four positions at 90-degree increments and barrel diameters are 1-3/8 inches (9.5 mm) to fit most machines
- Rack pitch is 32-8 teeth per inch
- Uses our exclusive long-lasting Graf-Tite® soft-seat cutting tips with in-tip gas mixing for added resistance to flashbacks
- SC781A high-capacity three-hose torch cuts up to 12 inches (305 mm) with acetylene or propylene and 20 inches (508 mm) with LP or natural gas
- SC770 and SC772A two-hose torches cut up to 12 inches (305 mm) with acetylene, propylene, LP or natural gas

## Torches

| Stock Number | Head Angle in Degrees | Length Inches (mm) |
|--------------|-----------------------|--------------------|
|--------------|-----------------------|--------------------|

### Gas Axe Extra Heavy-Duty Cutting Torches

|       |     |            |
|-------|-----|------------|
| SC925 | 75  | 21 (533)   |
| SC929 | 90  | 21 (533)   |
| SC935 | 75  | 36 (914)   |
| SC939 | 90  | 36 (914)   |
| SC930 | 180 | 36 (914)   |
| SC945 | 75  | 48 (1,219) |
| SC949 | 90  | 48 (1,219) |
| SC940 | 180 | 48 (1,219) |
| SC965 | 75  | 72 (1,829) |
| SC969 | 90  | 72 (1,829) |
| SC960 | 180 | 72 (1,829) |

### Heavy-Duty Cutting Torches

|         |     |          |
|---------|-----|----------|
| SC175   | 75  | 17 (432) |
| SC179   | 90  | 17 (432) |
| SC225   | 75  | 21 (533) |
| SC225S* | 75  | 21 (533) |
| SC229   | 90  | 21 (533) |
| SC229S* | 90  | 21 (533) |
| SC220   | 180 | 21 (533) |
| SC365   | 75  | 36 (914) |
| SC369   | 90  | 36 (914) |
| SC360   | 180 | 36 (914) |

\*Torch head made with thicker-wall manganese bronze for more severe service.

### Heavy-Duty Combination Torches

|        |        |            |
|--------|--------|------------|
| SC205  | 75     | 12.5 (318) |
| SC209  | 90     | 12.5 (318) |
| WH200A | Handle | 7.5 (191)  |

### Medium-Duty Combination Torches

|       |        |             |
|-------|--------|-------------|
| MC505 | 75     | 11.25 (286) |
| MC509 | 90     | 11.25 (286) |
| WH100 | Handle | 7 (178)     |

### Toughcut Combination Torches

|        |        |             |
|--------|--------|-------------|
| CC509P | 90     | 11.25 (286) |
| WH100  | Handle | 7 (178)     |

### Standard-Duty Combination Torches

|       |        |            |
|-------|--------|------------|
| AC309 | 90     | 8.5 (216)  |
| AW1A  | Handle | 5.75 (146) |

### Machine Torches

|        |   |             |
|--------|---|-------------|
| SC781A | — | 15.5 (394)  |
| SC772A | — | 13.75 (349) |
| SC770  | — | 8 (203)     |

See page 100 for heavy-duty tips to use with cutting torches and combination torches.

See page 101 for medium-duty tips to use with combination torches.

## Most popular accessories



- Circle Cutter Guide 16229



- Flashback Arrestor Set (oxy and fuel) H743 Torch mount  
H753 Regulator mount

Visit [MillerWelds.com](http://MillerWelds.com) or your distributor for other Miller® options and accessories.

# Heavy-Duty Outfits



HBA-40510

## Combination torch outfits

Outfits include just about everything needed for your cutting, welding, brazing or heating project.

- Heavy-duty Series 40™ regulators (HBA-40XXX) **OR** medium-duty Series 30™ regulators (HBA-30XXX)
- Heavy-duty combination torch
- Torch-mount flashback arrestors (acetylene outfits) **OR** regulator-mount check valves (propane outfit) for added safety
- Exclusive long-lasting Graf-Tite® soft-seat cutting tips with in-tip gas mixing for added resistance to flashbacks
- HBA-40510 and HBA-40300 outfits each cut up to 1-1/4 inch (32 mm) with tip included, other outfits cut up to 5/8 inch (16 mm)
- All outfits cut up to 8 inches (203 mm) with optional tips



16206

16280

## Combination torch and tips packs

Combination packs are available with cutting, welding and heating tips **OR** with multiple cutting tips.

- Heavy-duty combination torch
- Torch-mount flashback arrestors for added safety
- Exclusive long-lasting Graf-Tite® soft-seat cutting tips with in-tip gas mixing for added resistance to flashbacks
- Cuts up to 5/8 inch (16 mm) with tip included
- Cuts up to 8 inches (203 mm) with optional tips



HBS-H510S

HBAS-30510

## Cutting torch outfits

Hand cutting torch outfits are built for the toughest jobs and include a 21-inch nickel-plated torch with reversible (top or bottom) mount cutting lever and an ease-on oxygen feature that reduces slag blowback when piercing.

- Heavy-duty Series 40™ regulators with gauge guards (HBS outfits) **OR** medium-duty Series 30™ regulators (HBAS outfits)
- Heavy-duty hand cutting torch
- Torch-mount flashback arrestors (HBAS outfits) for added safety
- Exclusive long-lasting Graf-Tite® soft-seat cutting tips with in-tip gas mixing for added resistance to flashbacks
- HBS outfits cut up to 1-1/4 inch (32 mm) with tip included, HBAS outfits cut up to 5/8 inch (16 mm)
- All outfits cut up to 12 inches (305 mm) with optional tips

## Heavy-duty tips

| Stock Number                       | Max. Metal Thickness Inches (mm) | Cutting Jet Drill Size |
|------------------------------------|----------------------------------|------------------------|
| <b>Acetylene Cutting</b>           |                                  |                        |
| SC12-00                            | 3/16 (5)                         | 68                     |
| SC12-0                             | 3/8 (10)                         | 62                     |
| SC12-1                             | 5/8 (16)                         | 56                     |
| SC12-2                             | 1-1/4 (32)                       | 54                     |
| SC12-3                             | 2 (51)                           | 51                     |
| SC12-4                             | 4 (102)                          | 45                     |
| SC12-5                             | 8 (203)                          | 41                     |
| SC12-6                             | 12 (305)                         | 32                     |
| <b>Propane/Natural Gas Cutting</b> |                                  |                        |
| SC50-00                            | 3/16 (5)                         | 68                     |
| SC50-0                             | 3/8 (10)                         | 62                     |
| SC50-1                             | 5/8 (16)                         | 56                     |
| SC50-2                             | 1-1/4 (32)                       | 54                     |
| SC50-3                             | 2 (51)                           | 51                     |
| SC50-4                             | 4 (102)                          | 45                     |
| SC50-5                             | 8 (203)                          | 41                     |
| SC50-6                             | 12 (305)                         | 32                     |
| SC50-7                             | 14 (354)                         | 28                     |
| SC50-8                             | 18 (457)                         | 17                     |
| SC50-9                             | 20 (508)                         | 3                      |
| <b>Propylene Cutting</b>           |                                  |                        |
| SC60-0                             | 3/8 (10)                         | 62                     |
| SC60-1                             | 5/8 (16)                         | 56                     |
| SC60-2                             | 1-1/4 (32)                       | 54                     |
| SC60-3                             | 2 (51)                           | 51                     |
| SC60-4                             | 4 (102)                          | 45                     |
| SC60-5                             | 8 (203)                          | 41                     |
| SC60-6                             | 12 (305)                         | 32                     |
| <b>Acetylene Gouging</b>           |                                  |                        |
| SC13-3                             | 3/8 (10) wide, 1/4 (6) deep      |                        |
| <b>Propane/Natural Gas Gouging</b> |                                  |                        |
| SC23-3                             | 3/8 (10) wide, 1/4 (6) deep      |                        |
| <b>Propylene Gouging</b>           |                                  |                        |
| SC23-3M                            | 3/8 (10) wide, 1/4 (6) deep      |                        |
| <b>Acetylene Welding</b>           |                                  |                        |
| SW201                              | 1/32 in. (0.7 mm)                |                        |
| SW203                              | 5/64 in. (1.9 mm)                |                        |
| SW205                              | 1/8 in. (3 mm)                   |                        |
| SW207                              | 3/16 in. (5 mm)                  |                        |
| SW209                              | 3/8 in. (10 mm)                  |                        |
| SW210                              | 1/2 in. (13 mm)                  |                        |
| <b>Acetylene Heating</b>           |                                  |                        |
| ST602                              | 40,000 Btu                       |                        |
| ST603                              | 72,000 Btu                       |                        |
| ST605                              | 125,000 Btu                      |                        |
| ST610                              | 195,000 Btu                      |                        |

Visit [MillerWelds.com](http://MillerWelds.com) or your distributor for additional tips, options and accessories.

| Outfit                             | Stock Number | Fuel                | Oxygen Regulator | Fuel Gas Regulator | Torch        | Cut Tip        | Weld Tip | Heat Tip | Accessories   |
|------------------------------------|--------------|---------------------|------------------|--------------------|--------------|----------------|----------|----------|---|
| Combination Torch Complete Outfits | HBA-40510    | Acetylene           | 40-175-540       | 40-15-510          | SC209/WH200A | SC12-1, SC12-2 | SW205    | ST602    | 25 ft. (7.6 m), 1/4 in. (6 mm) "R"-grade hose, lighter, shade 5 safety glasses, tip cleaner and flashback arrestors |
|                                    | HBA-40300    |                     | 40-175-540       | 40-15-300          |              |                |          |          |   |
|                                    | HBA-30510    |                     | 30-100-540       | 30-15-510          | SC209/WH200A | SC12-1         | SW205    | ST602    |   |
|                                    | HBA-30300    |                     | 30-100-540       | 30-15-300          |              |                |          |          |   |
|                                    | HBA-30510LP  | Propane/natural gas | 30-100-540       | 30-50-510          | SC209/WH200A | SC40-1         | —        | ST615    |   |
| Combination Torch and Tip Packs    | 16206        | Acetylene           | —                | —                  | SC209/WH200A | SC12-1         | SW203    | ST602    | H743 flashback arrestors  |
|                                    | 16280        |                     | —                | —                  | SC209/WH200A | SC12-0, SC12-1 | —        | —        |   |
| Cutting Torch Outfits              | HBS-H510S    | Acetylene           | 40-175-540S      | 40-15-510S         | SC229        | SC12-2         | —        | —        | "S" designation on regulators denotes inclusion of Hard Hat™ gauge guard  |
|                                    | HBS-H300S    |                     | 40-175-540S      | 40-15-300S         |              |                |          |          |   |
|                                    | HBAS-30510   |                     | 30-100-540       | 30-15-510          | SC229        | SC12-1         | —        | —        |   |
|                                    | HBAS-30300   |                     | 30-100-540       | 30-15-300          |              |                |          |          |   |

# Medium-Duty Outfits



## Combination torch outfits

Outfits include just about everything needed for your cutting, welding, brazing or heating project.

- Medium-duty Series 30™ regulators
- Medium-duty combination torch
- Torch-mount flashback arrestors (acetylene outfits) **OR** regulator-mount check valves (propane outfit) for added safety
- Exclusive long-lasting Graf-Tite® soft-seat cutting tips with in-tip gas mixing provides for resistance to flashbacks
- Cuts up to 5/8 inch (16 mm) with tip included
- Cuts up to 6 inches (153 mm) with optional tips

## Medium-duty tips

| Stock Number                       | Max. Metal Thickness Inches (mm) | Cutting Jet Drill Size |
|------------------------------------|----------------------------------|------------------------|
| <b>Acetylene Cutting</b>           |                                  |                        |
| <b>MC12-00</b>                     | 3/16 (5)                         | 68                     |
| <b>MC12-0</b>                      | 3/8 (10)                         | 62                     |
| <b>MC12-1</b>                      | 5/8 (16)                         | 55                     |
| <b>MC12-2</b>                      | 1 (25)                           | 54                     |
| <b>MC12-3</b>                      | 2 (51)                           | 51                     |
| <b>MC12-4</b>                      | 4 (102)                          | 45                     |
| <b>MC12-5</b>                      | 6 (152)                          | 41                     |
| <b>Propane/Natural Gas Cutting</b> |                                  |                        |
| <b>MC40-00</b>                     | 3/16 (5)                         | 68                     |
| <b>MC40-0</b>                      | 3/8 (10)                         | 62                     |
| <b>MC40-1</b>                      | 5/8 (16)                         | 55                     |
| <b>MC40-2</b>                      | 1-1/4 (32)                       | 54                     |
| <b>MC40-3</b>                      | 2 (51)                           | 51                     |
| <b>MC40-4</b>                      | 4 (102)                          | 51                     |

## Propylene Cutting

|               |            |    |
|---------------|------------|----|
| <b>MC60-1</b> | 5/8 (16)   | 55 |
| <b>MC60-2</b> | 1-1/4 (32) | 54 |
| <b>MC60-3</b> | 2 (51)     | 51 |
| <b>MC60-4</b> | 4 (102)    | 45 |

## Acetylene Gouging

|               |                             |
|---------------|-----------------------------|
| <b>MC13-3</b> | 3/8 (10) wide, 1/4 (6) deep |
|---------------|-----------------------------|

Note: Tips above fit medium- and standard-duty torches.

## Acetylene Welding

|              |                   |
|--------------|-------------------|
| <b>MW201</b> | 1/32 in. (0.7 mm) |
| <b>MW203</b> | 5/64 in. (1.9 mm) |
| <b>MW205</b> | 1/8 in. (3 mm)    |
| <b>MW207</b> | 3/16 in. (5 mm)   |
| <b>MW209</b> | 3/8 in. (10 mm)   |

## Acetylene Heating

|              |             |
|--------------|-------------|
| <b>MT603</b> | 40,000 Btu  |
| <b>MT605</b> | 73,000 Btu  |
| <b>MT610</b> | 129,000 Btu |

## Propane/Natural Gas Heating

|              |                     |
|--------------|---------------------|
| <b>MT800</b> | 93,000 Btu          |
| <b>MT805</b> | 208,000 Btu         |
| <b>MT615</b> | 269,000/182,000 Btu |

Visit [MillerWelds.com](http://MillerWelds.com) or your distributor for additional tips, options and accessories.



## Combination torch and tips packs

Combination packs are available with cutting, welding and heating tips **OR** with multiple cutting tips.

- Medium-duty combination torch
- Torch-mount flashback arrestors for added safety
- Exclusive long-lasting Graf-Tite® soft-seat cutting tips with in-tip gas mixing for added resistance to flashbacks
- Cuts up to 5/8 inch (16 mm) with tip included
- Cuts up to 6 inches (153 mm) with optional tips



## Toughcut™ combination torch outfits

Outfits include many features found on more expensive outfits.

- Medium-duty Series 30™ regulators
- Toughcut combination torch
- Regulator-mount check valves for added safety and torch life
- Exclusive long-lasting Graf-Tite® soft-seat cutting tips with in-tip gas mixing for added resistance to flashbacks
- Cuts up to 5/8 inch (16 mm) with tip included
- Cuts up to 6 inches (153 mm) with optional tips



## Tag-A-Long™ and Versa-Torch™ portable outfits

Complete, portable outfits housed in carriers designed for mobility and ease of storage.

- Medium-duty Series 30™ regulators
- Medium-duty combination torch (Tag-A-Long) **OR** standard-duty combination torch (Versa-Torch)
- Regulator-mount check valves for added safety and torch life
- Exclusive long-lasting Graf-Tite® soft-seat cutting tips

| Outfit                             | Stock Number      | Fuel                | Oxygen Regulator | Fuel Gas Regulator | Torch        | Cut Tip        | Weld Tip            | Heat Tip | Accessories   |
|------------------------------------|-------------------|---------------------|------------------|--------------------|--------------|----------------|---------------------|----------|---|
| Combination Torch Complete Outfits | MBA-30510         | Acetylene           | 30-100-540       | 30-15-510          | MC509/WH100  | MC12-0, MC12-1 | MW205               | MT603    | 20 ft. (6.1 m), 3/16 in. (5 mm) "R"-grade hose, lighter, shade 5 safety glasses, tip cleaner and flashback arrestors  |
|                                    | MBA-30300         |                     | 30-100-540       | 30-15-300          |              |                |                     |          |   |
|                                    | MBA-30510LP       | Propane/natural gas | 30-100-540       | 30-50-510          | MC509/WH100  | MC40-1         | —                   | MT805    |   |
| Combination Torch and Tip Packs    | 16205             | Acetylene           | —                | —                  | MC509/WH100  | MC12-1         | MW203               | MT603    | Flashback arrestors   |
|                                    | 16281             |                     | —                | —                  | MC509/WH100  | MC12-0, MC12-1 | —                   | —        |   |
| Toughcut Combination Torch Outfits | MB55A-510         | Acetylene           | 30-100-540       | 30-15-510          | CC509P/WH100 | MC12-1         | MW205               | MT603    | 20 ft. (6.1 m), 3/16 in. (5 mm) "R"-grade hose, lighter, shade 5 safety glasses and check valves  |
|                                    | MB55A-300         |                     | 30-100-540       | 30-15-300          |              |                |                     |          |   |
| Combination Torch Portable Outfits | TL-500 (no tanks) | Acetylene           | 30-100-540       | 30-15-200          | CC509P/CW5A  | MC12-0         | MW203               | —        | 12.5 ft. (3.8 m), 3/16 in. (5 mm) "R"-grade hose, carrier, lighter, shade 5 safety glasses, check valves, oxygen cylinder and acetylene cylinder (cylinders NOT included with TL-500) |
|                                    | TL-550            |                     | 30-100-540       | 30-15-200          | AC309/AW1A   | MC12-00        | LT103, LT104, LT106 | 13716    |   |

# NEW! Toughcut™ Select Combo Packs



## Toughcut torch and tips packs

Easy and economic way to make changes to your oxy-fuel system without needing to buy a full outfit. Includes single-flint lighter and shade 5 safety glasses.

- Medium-duty torch
- Torch-mount flashback arrestors for added safety
- Exclusive long-lasting Graf-Tite® soft-seat cutting tips with in-tip gas mixing for added resistance to flashbacks
- Pack 287643 cuts up to 1 inch (25 mm) with tip included, pack 287644 cuts up to 1-1/4 inch (32 mm) with tip included
- Cuts up to 6 inches (153 mm) with optional tips



## Toughcut torch and regulators packs

Easy and economic way to make changes to your oxy-fuel system without needing to buy a full outfit. Includes single-flint lighter and shade 5 safety glasses.

- Medium-duty Series 30™ regulators
- Medium-duty torch
- Torch-mount flashback arrestors for added safety

## Medium-duty tips

| Stock Number   | Max. Metal Thickness Inches (mm) | Cutting Jet Drill Size |
|--|----------------------------------|------------------------|
| <b>Acetylene Cutting</b>   |                                  |                        |
| MC12-00  | 3/16 (5)                         | 68                     |
| MC12-0   | 3/8 (10)                         | 62                     |
| MC12-1   | 5/8 (16)                         | 55                     |
| MC12-2   | 1 (25)                           | 54                     |
| MC12-3   | 2 (51)                           | 51                     |
| MC12-4   | 4 (102)                          | 45                     |
| MC12-5   | 6 (152)                          | 41                     |
| <b>Propane/Natural Gas Cutting</b>   |                                  |                        |
| MC40-00  | 3/16 (5)                         | 68                     |
| MC40-0   | 3/8 (10)                         | 62                     |
| MC40-1   | 5/8 (16)                         | 55                     |
| MC40-2   | 1-1/4 (32)                       | 54                     |
| MC40-3   | 2 (51)                           | 51                     |
| MC40-4   | 4 (102)                          | 51                     |
| <b>Acetylene Heating</b>   |                                  |                        |
| MT603  | 40,000 Btu                       |                        |
| MT605  | 73,000 Btu                       |                        |
| MT610  | 129,000 Btu                      |                        |
| <b>Propane/Natural Gas Heating</b>   |                                  |                        |
| MT615  | 269,000/182,000 Btu              |                        |
| See page 101 for a more comprehensive list of medium-duty tips for use with Toughcut select combo packs. |                                  |                        |

| Outfit                             | Stock Number | Fuel                | Oxygen Regulator | Fuel Gas Regulator | Torch        | Cut Tip        | Heat Tip | Accessories   |
|------------------------------------|--------------|---------------------|------------------|--------------------|--------------|----------------|----------|---|
| Toughcut Torch and Tip Packs       | 287643       | Acetylene           | —                | —                  | CC509P/WH100 | MC12-1, MC12-2 | MT603    | Lighter, shade 5 safety glasses and flashback arrestors |
|                                    | 287644       | Propane/natural gas | —                | —                  | CC509P/WH100 | MC40-1, MC40-2 | MT615    |   |
| Toughcut Torch and Regulator Packs | 287641       | Acetylene or LP gas | 30-100-540       | 30-15-510          | CC509P/WH100 | —              | —        | Lighter, shade 5 safety glasses and flashback arrestors |
|                                    | 287642       | Acetylene           | 30-100-540       | 30-15-300          | CC509P/WH100 | —              | —        |   |

# Proportional Gas Mixers

Our line of proportional gas mixers can help your operation save money, work more efficiently and produce better-quality welds by providing proper shielding gas mixtures for frequently used welding processes.



Argon/CO<sub>2</sub> gas mixer 299-006-1C shown.

**Accurate, on-site shield gas mixing.** Various welding processes require different gas mixes for the best results. Our proportional gas mixers are accurate and allow custom mixtures for optimal welds.

**No stocking or handling of premixed gases** saves time and money and also reduces the number of cylinders that need to be stored.

**Reduces setup time.** No need to change cylinders, regulators, flow control devices or hoses when switching from one range of mixed gas to another.

**Ideal for education and training.** Operators can quickly see the effect of various gas mixtures on weld appearance, quality and penetration.

**Easy operation.** Simply set the dials for the desired mix and flow. Mixers are mechanical, no electricity is required.

**Serves from one to five welding stations with a single mixer.** Delivers accurate mixtures at flows ranging from 10 to 180 scfh.

**Covered by a one-year warranty.**

| Stock Number | Gases           | Adjustment % Range | Flow Range  | Outlet Pressure   | Required Inlet Pressure    | Outlet Connection   | Inlet Connection     | Conversion Tables  |
|--------------|-----------------|--------------------|-------------|-------------------|----------------------------|---------------------|----------------------|--|
| 299-006-1C   | Argon           | 0-100%             | 10-180 scfh | 50 psig (3.5 bar) | 105-115 psig (7.3-7.9 bar) | 5/8"-18 RH internal | 5/8"-18 RH internal  | Argon/helium<br>Argon/oxygen<br>CO <sub>2</sub> /oxygen                      |
|              | CO <sub>2</sub> | 100-0%             |             |                   |                            |                     | 5/8"-18 RH internal  |  |
| 299-006-3C   | Argon           | 0-100%             | 10-180 scfh | 50 psig (3.5 bar) | 105-115 psig (7.3-7.9 bar) | 5/8"-18 RH internal | 5/8"-18 RH internal  | Argon/CO <sub>2</sub><br>Argon/oxygen<br>CO <sub>2</sub> /oxygen             |
|              | Helium          | 100-0%             |             |                   |                            |                     | 5/8"-18 RH internal  |  |
| 299-011-1C   | Argon           | 50-100%            | 10-180 scfh | 50 psig (3.5 bar) | 105-115 psig (7.3-7.9 bar) | 5/8"-18 RH internal | 5/8"-18 RH internal  | Argon/helium<br>Nitrogen/hydrogen<br>Argon/oxygen<br>Argon/CO <sub>2</sub>   |
|              | Hydrogen        | 50-0%              |             |                   |                            |                     | 9/16"-18 LH external |  |
| 299-014-1C   | Argon           | 80-100%            | 10-180 scfh | 50 psig (3.5 bar) | 105-115 psig (7.3-7.9 bar) | 5/8"-18 RH internal | 5/8"-18 RH internal  | Argon/CO <sub>2</sub><br>Argon/hydrogen<br>Argon/helium<br>Nitrogen/hydrogen |
|              | Oxygen          | 20-0%              |             |                   |                            |                     | 5/8"-18 RH internal  |  |



For more detailed information, visit

MillerWelds.com/safety

# Welding Safety and Health



## Safety products designed to protect welders and enhance their long-term performance

The Miller focus has always been welding – understanding welders, their needs and the safety products used to protect them within their work environments. We provide multiple solutions for weld fume control that fulfill each level of OSHA’s hierarchy of controls. We will help you get maximum productivity out of each welder while keeping them comfortable and improving compliance. Our complete line of Weld Environment, Head and Face, and Hand and Body protection is designed to protect and perform in demanding welding, cutting and grinding applications.

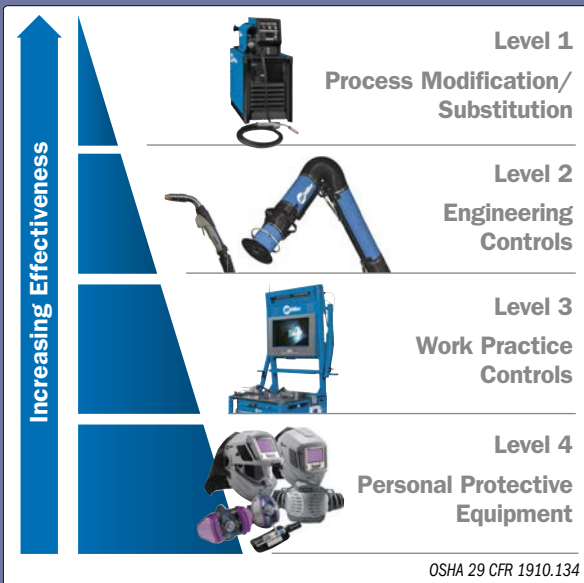

## Fume Extractors

Our line of FILTAIR® fume extractors are designed specifically for welding – drawing weld fumes away from the user’s breathing zone and keeping your facility clean. We offer many types of fume extraction equipment to best fit your environment. Visit MillerWelds.com/filtair for more information.

| FILTAIR                         | 130 (page 103)   | MWX (page 104)   | Capture 5 (page 104)  | SWX (page 105)   | 4000–12000 (page 106)   |
|---------------------------------|--|--|---|--|---|
| <b>Weld Fume Extractor Type</b> | Portable, high-vacuum  | Mobile, low-vacuum                                     | Mobile, low-vacuum with the industry’s largest capture zone                         | Stationary, low-vacuum suited for wall or column mounting  | Centralized, low-vacuum customizable systems  |
| <b>Ideal For</b>                | Contractors, maintenance and repair operations, light fabrication work and light manufacturing | Fabrication shops, manufacturing, and training centers | Manufacturing and fabrication – the best solution for weldments over 18 inches long | Fabrication shops, manufacturing, and training centers where weld areas are near filtration system | Manufacturing, hand-held and automation, fabrication shops, and training facilities |
| <b>Technology</b>               | –  | –  | ZoneFlow (see pg 106)   | Available w/ZoneFlow (see pg 106)  | Available w/ZoneFlow (see pg 106)   |
| <b>Welding Arcs</b>             | 1  | 1  | 1   | Up to 2 per unit   | Up to 16 per unit   |
| <b>Filter Type</b>              | Manual cleaning  | MWX-D: Disposable<br>MWX-S: Self-cleaning              | Self-cleaning (automatic)   | SWX-D: Disposable<br>SWX-S: Self-cleaning  | Self-cleaning (automatic/programmable)  |

## FILTAIR® 130

See literature AY/3.1



**Portable, high-vacuum weld fume extractor designed for use with accessories like nozzles and fume guns to collect weld fume particles at the source.**

**Designed to capture weld fume.** The MERV 15 rating of FilTek XL filters provides superior filtering of up to 95 percent of weld fume particulate.

**Unrivaled filtering performance.** Designed to capture weld fume particles with a cleanable filter and safely deposit them in an integrated particle bin.

**Accu-Rated™ suction power** of 132 cfm at the hood opening.

*Note: Accu-Rated is the true, accurate airflow at the inlet of the collection hood.*

**Less noise.** Up to 70 percent quieter than some other extractors. Only 68.5 decibels at five feet.

**Portable and compact.** At only 46 pounds (21 kg) the vertical-shaped machine is easy to move around.

### Processes

- Stick (SMAW) ▪ Flux-cored (FCAW)
- MIG (GMAW) ▪ TIG (GTAW)

### Comes with

- FilTek® XL filter
- 8 ft. (2.4 m) collection hose
- 20 ft. (6 m) power cord

### Most popular consumables

- FilTek® XL Filter 301267

### Most popular accessories

- Collection Hose  
300896 17 ft. (5.2 m)  
300897 34 ft. (10.4 m)

### ▪ Magnetic

### Nozzle

- 300895  
12 in. (305 mm) width



- Flexible Funnel Magnetic Nozzle 300668

- Bernard® Clean Air™ Fume Extraction MIG Gun (pg 26)

| Stock Number<br>(300595) | Accu-Rated™ Airflow | Sound Level               | Motor   | Input Power                      | Dimensions   | Net Weight     |
|--------------------------|---------------------|---------------------------|---------|----------------------------------|--|----------------|
|                          | 132 cfm (62 L/sec.) | 68.5 dBA at 5 ft. (1.5 m) | 1.27 kW | 115 V, 1-phase, 60 Hz at 11.25 A | H: 23 in. (584 mm)<br>W: 12 in. (305 mm)<br>D: 12 in. (305 mm) | 46 lb. (21 kg) |



## FILTAIR® MWX Series and Capture 5

See literature AY/3.0 (MWX) and AY/3.5 (Capture 5)

**Mobile fume extraction systems easily positioned near the weld area and designed specifically for welding. Disposable or cleanable filter models for multiple applications.**



MWX-S (self-cleaning filter) model shown with 10 ft. extraction arm.

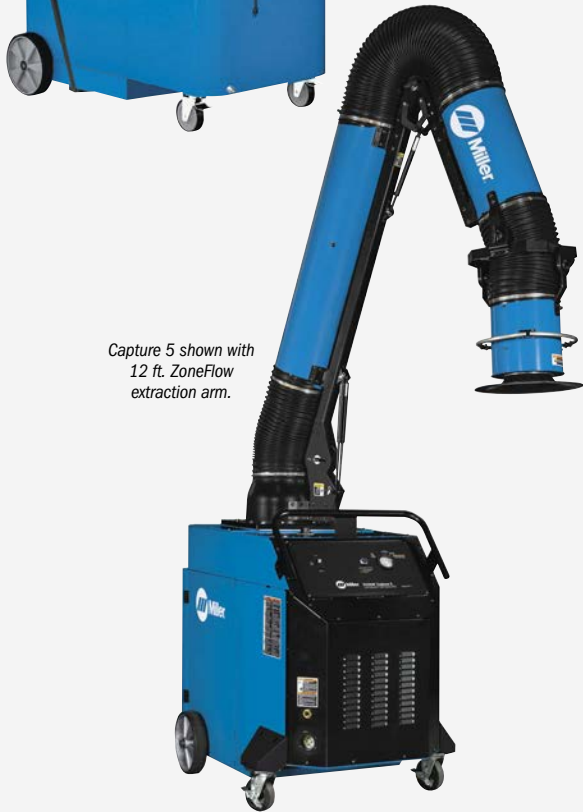

Capture 5 shown with 12 ft. ZoneFlow extraction arm.

### Features common to all models

**Source capture.** Designed to draw weld fume away from the welder's breathing zone and keep the facility clean.

**Superior filters.** The MERV 15 rating of our FilTek XL filters provides superior filtering of up to 95 percent of weld fume particulate. They outlast, out-filter, and outperform all the rest.

**Class-leading suction power** of 875 cfm (MWX) or 900 cfm (Capture 5) is Accu-Rated™ at the hood to better capture weld fumes and provide a cleaner environment.

*Note: Accu-Rated is the true, accurate airflow at the inlet of the collection hood.*

**Durable aluminum pre-assembled extraction arm** with external adjustments for better airflow and longer life.

### Self-cleaning models additional features

**Upgrade to self-cleaning models** for high arc-on time, extracting from heavy fume processes, or when welding aluminum or galvanized materials.

**Unrivaled filtering performance.** Weld fume particles are captured with a cleanable filter and safely deposited in an integrated particle bin.

**Quick and efficient cleaning cycle** operates with a push of a button on the control panel.

*Note: Compressed air required to operate cleaning mechanism.*

**Disposal drawer** provides easy and convenient access to empty out collected particles. Handle releases drawer allowing it to slide out.

### Capture 5 model additional features

**EXCLUSIVE! ZoneFlow™ technology.** Extends the capture zone up to five feet versus up to 18 inches with conventional source capture arms. See page 106 for more information.

**Minimizes downtime with fewer fume extractor adjustments.** With increased capture area, arm interactions are dramatically minimized.

### Processes

- Stick (SMAW) ▪ Flux-cored (FCAW)
- MIG (GMAW) ▪ TIG (GTAW)

### Comes with

- FilTek® XL filter
- Pre-assembled arm

### Most popular consumables



### Replacement FilTek XL Filters

- 300540 For MWX (self-cleaning)
  - 300539 For MWX (disposable)
  - 301106 For Capture 5 (self-cleaning)
- Filters efficiently capture the smallest weld fume particles and offer superior filter life

### Most popular accessories



### Hood Light with Arc Sensor

- 300689 For MWX Series
- Illuminates the welding zone and enables the fume extractor to start automatically when welding begins

| Model/Stock Number   |   | Filter Media                 | Accu-Rated™ Airflow     | Extraction Arm Diameter | Sound Level                                 | Motor              | Input Power   | Dimensions   | Net Weight   |
|--|---|------------------------------|-------------------------|-------------------------|---|--------------------|---|--|--|
| <b>MWX-S (Self-Cleaning)</b><br>(951510) 7 ft. standard arm<br>(951511) 10 ft. standard arm<br>(951512) 12 ft. standard arm  | <b>MWX-D (Disposable Filter)</b><br>(951507) 7 ft. standard arm<br>(951508) 10 ft. standard arm<br>(951509) 12 ft. standard arm | 490 sq. ft.<br>(45.52 sq. m) | 875 cfm<br>(413 L/sec.) | 8 in.<br>(203 mm)       | Approximately<br>70 dBA at<br>5 ft. (1.5 m) | 1 hp,<br>3,450 rpm | 115 V, 1-phase,<br>60 Hz at<br>approximately 11.9 A                         | H: 34.75 in. (883 mm)<br>W: 31.75 in. (806 mm)<br>D: 48 in. (1,219 mm) | MWX-S:<br>300 lb. (136 kg)<br>MWX-D:<br>238 lb. (108 kg) |
| <b>Capture 5 (Self-Cleaning)</b><br>(951639) 208/230 V, 10 ft. ZoneFlow arm<br>(951640) 208/230 V, 12 ft. ZoneFlow arm<br>(951574) 460 V, 10 ft. ZoneFlow arm<br>(951575) 460 V, 12 ft. ZoneFlow arm |   | 452 sq. ft.<br>(42 sq. m)    | 900 cfm<br>(425 L/sec.) | 10 in.<br>(254 mm)      | Approximately<br>77 dBA at<br>5 ft. (1.5 m) | 3 hp,<br>3,450 rpm | 208/230 V, 1-phase,<br>60 Hz at 13.5 A<br>460 V, 3-phase,<br>60 Hz at 3.7 A | H: 43 in. (1,092 mm)<br>W: 36 in. (915 mm)<br>D: 48 in. (1,219 mm)     | 620 lb. (282 kg)<br>with 12 ft. arm                      |

## FILTAIR® SWX Series See literature AY/3.2

Stationary fume extraction systems, wall- or column-mounted next to the weld area and designed specifically for welding. Disposable or cleanable filter models for multiple applications.



SWX-D (disposable filter) model shown with telescoping arm.



SWX-S (self-cleaning filter) model shown with 12 ft. ZoneFlow extraction arm.

### Features common to both models

**Source capture.** Designed to draw weld fume away from the welder's breathing zone and keep the facility clean.

**Superior filters.** The MERV 15 rating of our FilTek XL filters provides superior filtering of up to 95 percent of weld fume particulate. They outlast, out-filter, and outperform all the rest.

**Class-leading suction power of 875 cfm** is Accu-Rated™ at the hood to better capture weld fumes and provide a cleaner environment.

*Note: Accu-Rated is the true, accurate airflow at the inlet of the collection hood.*

**Durable aluminum pre-assembled extraction arms.** Choose from three different arm styles:

- **Telescoping arms** fit small booth spaces and telescope from 3 to 4.5 feet
- **Standard arms** cover larger spaces and are available in 7-, 10-, and 12-foot versions
- **ZoneFlow arms (self-cleaning models only)** extend the capture zone up to 5 feet and are available in 10- and 12-foot versions

### Self-cleaning model additional features

**Upgrade to self-cleaning models** for high arc-on time, extracting from heavy fume processes, or when welding aluminum or galvanized materials.

**Unrivaled filtering performance.** Weld fume particles are captured with a cleanable filter and safely deposited in an integrated particle bin.

**Quick and efficient cleaning cycle** operates with a push of a button on the control panel.

*Note: Compressed air required to operate cleaning mechanism.*

**Disposal drawer** provides easy and convenient access to empty out collected particles. Handle releases drawer allowing it to slide out.

### ZoneFlow™ arm additional features

**EXCLUSIVE! ZoneFlow technology.** Extends the capture zone up to five feet versus up to 18 inches with conventional source capture arms. See page 106 for more information.

**Minimizes downtime with fewer fume extractor adjustments.** With increased capture area, arm interactions are dramatically minimized.

### Processes

- Stick (SMAW) ▪ Flux-cored (FCAW)
- MIG (GMAW) ▪ TIG (GTAW)

### Comes with

- FilTek® XL filter
- Pre-assembled arm

### Most popular consumables



#### ▪ Replacement FilTek XL Filters

- 300540 For self-cleaning models
  - 300539 For disposable filter models
- Filters efficiently capture the smallest weld fume particles and offer superior filter life

### Most popular accessories



#### ▪ Hood Light with Arc Sensor

- 300763 For SWX Series
- (telescoping and standard arms only) Illuminates the welding zone and enables the fume extractor to start automatically when welding begins



#### ▪ SWX Dual-Arm Add-On Packages

- 951621 With telescoping arm
  - 951519 With 7 ft. standard arm
  - 951520 With 10 ft. standard arm
  - 951521 With 12 ft. standard arm
  - 951762 With 10 ft. ZoneFlow arm
  - 951822 With 12 ft. ZoneFlow arm
- Includes 8-inch diameter arm, blower, control box, mounting bracket, duct and back draft dampers to turn single-arm weld fume extractor into dual-arm extractor

| Model/Stock Number  | Filter Media  | Accu-Rated™ Airflow       | Extraction Arm Diameter | Sound Level    | Motor  | Input Power   | Dimensions  | Net Weight without Arm   |
|---|---|---------------------------|-------------------------|----------------|--|---|---|--|
| <b>SWX-S (Self-Cleaning)</b><br>(951620) Telescoping arm<br>(951516) 7 ft. standard arm<br>(951517) 10 ft. standard arm<br>(951518) 12 ft. standard arm<br>(951760) 10 ft. ZoneFlow arm<br>(951761) 12 ft. ZoneFlow arm | <b>SWX-D (Disposable Filter)</b><br>(951619) Telescoping arm<br>(951513) 7 ft. standard arm<br>(951514) 10 ft. standard arm<br>(951515) 12 ft. standard arm | 490 sq. ft. (45.52 sq. m) | 875 cfm (413 L/sec.)    | 8 in. (203 mm) | Standard:<br>Approximately 75 dBA at 5 ft. (1.5 m)<br><br>ZoneFlow:<br>Approximately 80 dBA at 5 ft. (1.5 m) | 1 hp, 3,450 rpm<br><br>Blower motor:<br>115 V, 1-phase, 60 Hz at approximately 11.9 A<br><br>ZoneFlow:<br>115 V, 1-phase, 60 Hz at approximately 12 A | SWX-S H: 33 in. (838 mm)<br>SWX-D H: 29 in. (737 mm)<br>W: 27.25 in. (692 mm)<br>D: 33 in. (838 mm) | Cabinet:<br>SWX-S: 195 lb. (88 kg)<br>SWX-D: 130 lb. (59 kg)<br>Blower/bracket: 95 lb. (43 kg) |

# FILTAIR® 4000-12000 See literature AY/3.4

The industrial centralized weld fume extractors are custom-engineered solutions designed for multiple capture sources which require ducting and accessories to complete the system.



FILTAIR 4000 model shown. Other models are available (6000, 8000, and 12000).

**FILTAIR engineering resources.** Design and engineering resources recommend, develop and support custom-engineered solutions.

**Improves operating efficiency.** Creates a cleaner shop with less downtime spent cleaning equipment.

**Stand-alone space saver.** Our fully assembled fume extractor provides up to a 65 percent smaller footprint versus traditional cartridge-style extractors. It provides all the necessary extraction tools, while offering customizable options.

**Less noise.** Up to 75 percent quieter than cartridge-style extractors. High-efficiency motors and integrated silencer housing create a quieter, more productive work area.

**Integrated electrical controls.** Control panel manages all of the collector functions, including fan, filter differential, and pulse cleaning system.



**24 VDC motor start/stop feedback relay** allows an external signal to automate the remote start of collector fan from other equipment.

### FiTek XL filters

**Easy-clean filter** with surface-loaded filter technology allows for more effective weld fume pulse cleaning without penetration into the filter. This provides an easier filter cleaning process, while outlasting conventional cartridge filters.

**Smaller size and fewer filters.**

One FiTek XL filter replaces up to three cartridge-style filters increasing efficiency, reducing extractor size and lowering operational costs.



### ZoneFlow™ arm additional features

**EXCLUSIVE! ZoneFlow technology.** Extends capture zone up to five feet versus up to 18 inches with conventional source capture arms. See below for more information.

**Minimizes downtime with fewer fume extractor adjustments.** With increased capture area, arm interactions are dramatically minimized.

Call us toll-free at **866-931-9730** or email us at **FILTAIR@millerwelds.com** for information and requests for quotes on custom-engineered solutions to fit your needs.

\*Based on clean filters. \*\*Dimensions for base models without factory options.

### Processes

- Stick (SMAW) ■ Flux-cored (FCAW)
- MIG (GMAW) ■ TIG (GTAW)

### Custom solutions

- Configured to source fume extraction
- Configured for ambient push-pull collection

### Comes with

- FiTek® XL filter
- Top **OR** front air inlet
- Configured for indoor **OR** outdoor mounting (outdoor models are wind load and seismic rated and include remote-mounted control box)

### Most popular consumable

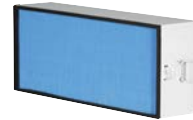

- Replacement High-Efficiency Filter** 300927

### Most popular accessories

- Extraction Arms (pg 107)
- Arm Mounting Bracket Kit (pg 107)
- Low Profile Hoods (pg 107)
- Call us toll-free at 866-931-9730 for information on factory options such as HEPA filter kit, weather hood, Spark Cooler® and integration services

| Model         | Nominal Airflow Range*                | Number of Filter Packs | Sound Level                                      | Input Power                       | Dimensions** (H x W x D)                                     | Ship Weight          |
|---------------|---------------------------------------|------------------------|--|-----------------------------------|--|----------------------|
| FILTAIR 4000  | 2,000-4,800 cfm (944-2,265 L/sec.)    | 4                      | 72-75 dBA at 5 ft. (1.5 m)                       | 230, 460 or 575 V, 3-phase, 60 Hz | 86.1 in. (2,187 mm) 31.2 in. (792 mm) 83.2 in. (2,113 mm)    | 1,600 lb. (726 kg)   |
| FILTAIR 6000  | 2,300-6,600 cfm (1,085-3,115 L/sec.)  | 6                      | Peak pulse cleaning is 92.7 dBA at 5 ft. (1.5 m) |                                   | 117.2 in. (2,977 mm) 31.2 in. (792 mm) 83.2 in. (2,113 mm)   | 2,250 lb. (1,021 kg) |
| FILTAIR 8000  | 2,500-7,000 cfm (1,180-3,304 L/sec.)  | 8                      |  |                                   | 135 in. (3,429 mm) 37.2 in. (945 mm) 83.2 in. (2,113 mm)     | 2,900 lb. (1,315 kg) |
| FILTAIR 12000 | 4,000-10,500 cfm (1,888-4,955 L/sec.) | 12                     |  |                                   | 120.3 in. (3,056 mm) 59.7 in. (1,516 mm) 83.2 in. (2,113 mm) | 3,900 lb. (1,769 kg) |

## ZoneFlow™ Technology

The capture zone redefined. Innovative, extended-capture fume extraction system designed specifically for welding.

ZoneFlow is a patented airflow technology that creates an extraction zone where the air on the inside of the zone has lower pressure than the air on the outside. The air pressure difference causes weld fume to get funneled to the center of the extraction arm, maximizing the weld fume capture distance. The increased capture zone reduces arm interactions so operators can keep welding, increasing arc-on time and productivity. Miller®-exclusive ZoneFlow technology is standard on the FILTAIR Capture 5, and optional on the FILTAIR SWX Series and FILTAIR 4000-12000 models (see pages 104, 105 and above).



**Conventional**

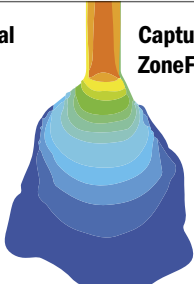

**Capture 5 ZoneFlow**

**Extend your fume capture zone.**

Conventional technology capture zone is up to 18 inches. ZoneFlow technology increases capture zone up to five feet and doesn't affect shielding gas or weld performance!



## FILTAIR® 4000–12000 Accessories

See literature AY/3.7 (Extraction Arms) and AY/3.6 (Low Profile Hoods)

Miller offers a full line of accessories for complete system solutions and turnkey installation.



### Easy-to-operate, pre-assembled extraction arms and mounting equipment

- **Telescoping arms** are designed to fit small booth spaces used in training centers and educational booths. Telescopes from 3 to 4.5 feet with a wide range of motion to cover all positions
- **Standard arms** are designed to cover larger spaces and are available in 7-, 10- and 12-foot versions. External brackets and adjustments allow air to pass through with less resistance giving you stronger cfm (airflow)
- **ZoneFlow™ arms** are designed to cover larger spaces and are available in 10- and 12-foot versions. ZoneFlow arms extend the capture zone up to five feet versus up to 18 inches with conventional source capture arms. External brackets and adjustments allow air to pass through with less resistance giving you stronger cfm (airflow)
- **Arm mounting bracket and ducting kit** includes a supporting bracket and collar for connecting an extraction arm to ductwork

| Model                                | 6-Inch Diameter        | 8-Inch Diameter        |
|--------------------------------------|------------------------|------------------------|
| Telescoping Arm                      | (301242) 3–4.5 ft. arm | (301237) 3–4.5 ft. arm |
| Standard Arm                         | (300953) 7 ft. arm     | (300980) 7 ft. arm     |
|                                      | (300954) 10 ft. arm    | (300981) 10 ft. arm    |
|                                      | (300955) 12 ft. arm    | (300982) 12 ft. arm    |
| ZoneFlow Arm with Motor Control Box  | (951810) 10 ft. arm    | (951758) 10 ft. arm    |
|                                      | (951811) 12 ft. arm    | (951759) 12 ft. arm    |
| Arm Mounting Bracket and Ducting Kit | (300952)               | (300771)               |

### Spark Cooler®

- Cools sparks using the fume extractor's airflow
- Very efficient – maximizes the extractor's power
- Simple design is easy to install



### FILTAIR low profile hood

- Available in sizes from 4 x 4 feet up to 16 x 16 feet in one-foot increments
- Exclusive design – capture velocity zone is maximized and distributed over the work area
- Hood airflow design reduces sound for better communication
- Unique airflow offers spark abatement in the extraction rail, as well as the recommended Spark Cooler
- Clear, UV-protected polycarbonate ceiling panels allow maximum light into the cell
- Corner lift hooks are convenient for installing or hanging over a work area. The hood can also be placed on an existing cell enclosure or supported with post assemblies

Call us toll-free at 866-931-9730 or email us at [FILTAIR@millerwelds.com](mailto:FILTAIR@millerwelds.com) for information and requests for quotes on custom-engineered solutions to fit your needs.

## Cleaner Air with FilTek® XL Filters

The FilTek XL filter's higher MERV rating means unrivaled filtering performance.

### MERV Comparison

| Applicable Weld Fume<br>MERV Rating Categories <sup>1</sup> | Particle Size Range Efficiency % <sup>2</sup> |           |            |
|---|---|-----------|------------|
|   | 0.3 to 1 µm                                   | 1 to 3 µm | 3 to 10 µm |
| 10  | Not Rated                                     | 50–65%    | 85%        |
| 11  | Not Rated                                     | 65–80%    | 85%        |
| 12  | Not Rated                                     | 80–90%    | 85%        |
| 13  | <75%  | 90%       | 90%        |
| 14  | 75–85%  | 90%       | 90%        |
| 15 Miller® FilTek XL  | 85–95%  | 90%       | 90%        |
| 16  | ≥95%  | ≥95%      | ≥95%       |
| HEPA <sup>3</sup>   | ≥99.97%                                       | ≥99.97%   | ≥99.97%    |
| Weld Fume Composition <sup>4</sup>                          | 75–95%  | ≤15%      | ≤10%       |

<sup>1</sup>American Society of Heating, Refrigeration and Air Conditioning Engineers (ASHRAE) 52.2

<sup>2</sup>National Air Filtration Association (NAFA) Guide

<sup>3</sup>HEPA filters are depth loading and have high restrictions to air flow, reducing system performance versus FilTek XL filters.

<sup>4</sup>Jenkins, Pierce, Edgar, Particle Size Distribution of GMAW and FCAW

Filters are rated on a MERV scale, which measures filter efficiency based on particle count. MERV ratings range from 1 to 16, with 16 being the best at filtering small particles – such as those found in weld fumes.

Filters in common air filtration systems often have MERV ratings from 7 to 11. FilTek XL filters are rated at class-leading MERV 15 to capture up to 95 percent of weld fume particulates.



## Respiratory

### Designed for comfort

**Well-balanced design** reduces torque on neck, increasing all-day wear.

**Patent-pending Dualtec™ manifold system** optimizes helmet balance and sound, while **six-point air distribution system** maximizes cooling through targeted air placement.

**Ergonomic headgear** provides secure fit without the need for over-tightening.

**Lightweight low-profile blower assembly with integrated shoulder straps (PAPR)** reduces lower back strain and fatigue.

**Lightweight versatile C50 air regulator (SAR)** can be positioned horizontally or vertically to naturally align with body movements.

### Superior visibility

**ClearLight™ Lens Technology** provides high-definition optics for precision arc recognition.

**Shade 5.0 side windows and oversized clear grind shield** maximize downward and peripheral visibility, improving sense of surroundings.

**Half-shade lens adjustability** provides fine shade adjustment for optimized comfort and vision.

### Improved productivity

**Enhanced comfort, cooling and visibility** maximize all-day wearability – increasing productivity, safety and regulatory compliance.

**Low-profile breathing-tube attachment** eases on/off process while flexible tube material reduces breathing tube snags in work cell.

**Two lightweight lithium-ion batteries (PAPR)** included with each package eliminate downtime.

**C50 air regulator (SAR)** supplies down to 50-degree Fahrenheit (28°C) Grade-D air under your hood, heightening productivity and relieving heat stress. Performance under different applications may vary. 360-degree swivel air hose connection alleviates hose coiling, reducing potential trip hazards.



### PAPR Powered Air-Purifying Respirator

See literature AY/4.1

**Available packages:**

**With T94-R™ helmet (external grind control)**  
**264573** With auto-darkening lens assembly  
**With T94i-R™ helmet (integrated clear grind shield)**  
**264575** With auto-darkening lens assembly

**With hard hat and Titanium 9400™ helmet (external grind control)**  
**259385** With auto-darkening lens assembly

**With hard hat and Titanium 9400i™ helmet (integrated clear grind shield)**  
**261659** With auto-darkening lens assembly

**T94-R™ helmet upgrade kit (for use with existing PAPR system)**  
**279870** Includes T94-R helmet assembly, breathing tube, breathing tube cover and flowmeter

**T94i-R™ helmet upgrade kit (for use with existing PAPR system)**  
**279871** Includes T94i-R helmet assembly, breathing tube, breathing tube cover and flowmeter

A complete PAPR system consists of blower assembly, HEPA filter, prefilters (6), spark guard, breathing tube, breathing tube cover, padded belt, comfortable shoulder straps, lithium-ion batteries (2), battery charger, flowmeter, tool bag and helmet assembly (see available packages at left).

- HEPA filter provides up to 99.97 percent filtration of airborne particles
- NIOSH 42 CFR 84 certified, assigned protection factor of 25



### SAR Supplied Air Respirator

See literature AY/4.3

**Available packages:**

**With T94i-R™ helmet (integrated clear grind shield)**  
**951800** With auto-darkening lens assembly and 25 ft. straight air hose  
**951801** With auto-darkening lens assembly and 100 ft. straight air hose  
**951802** With auto-darkening lens assembly and 25 ft. coiled air hose  
**951803** With auto-darkening lens assembly and 100 ft. coiled air hose  
**264871** With auto-darkening lens assembly (air hose not included)

**T94i-R™ helmet upgrade kit (for use with existing SAR system)**  
**279871** Includes T94i-R helmet assembly, breathing tube, breathing tube cover and flowmeter



### BreatheAir™ Portable Box

**275983** Two person, 10 ppm alarm  
**275985** Four person, 10 ppm alarm  
Supplies Grade-D breathing air while monitoring for CO.

### Monitor Calibration Kit

**275988** 10 ppm

A complete SAR system consists of C50 air regulator, belt assembly, flowmeter, breathing tube, breathing tube cover, tool bag, T94i-R helmet assembly and air hose (see available packages at left).

- NIOSH 42 CFR 84 certified, assigned protection factor of 25. To provide a NIOSH-approved respiratory system, the SAR with T94i-R must be used with Miller® helmet, hoses, connectors, filters and other components recommended by the manufacturer



## Respiratory



LPR-100 OV  
with P100/OV filters



LPR-100  
with P100 filters

**LPR-100™ OV Half Mask Respirator** See literature AY/4.5

**ML00996** Respirator with P100 organic vapor filters (small/medium)

**ML00997** Respirator with P100 organic vapor filters (medium/large)

**Filters and accessories**

**SA00820** P100/OV filters (one pair)

**285686** Protective hard carrying case

**261086** Quantitative fit-test kit adapter

- Low-profile design fits under T94™ and Elite™ welding helmets and provides maximum field of vision
- P100/OV filters provide up to 99.97 percent filtration of specific organic vapors and airborne particulates
- NIOSH 42 CFR 84 certified, assigned protection factor of 10

**LPR-100™ Half Mask Respirator** See literature AY/4.5

**ML00894** Respirator with P100 filters (small/medium)

**ML00895** Respirator with P100 filters (medium/large)

**ML00994** Respirator with P100 nuisance level OV relief filters (small/medium)

**ML00995** Respirator with P100 nuisance level OV relief filters (medium/large)

**Filters and accessories**

**SA00818** P100 filters (one pair)

**SA00819** P100 nuisance level OV relief filters (one pair)

**283374** Protective hard carrying case

**261086** Quantitative fit-test kit adapter

- Low-profile design fits under T94™, Elite™ and Classic welding helmets and provides maximum field of vision
- P100 filters provide up to 99.97 percent filtration of airborne particles
- Nuisance level OV relief filters are designed for use with organic vapor concentrations not exceeding OSHA's PELs or other applicable government occupational exposure limits, whichever is lower
- NIOSH 42 CFR 84 certified, assigned protection factor of 10

## GET THE LATEST NEWS FROM MILLER®

### SIGN UP FOR THE MILLER NEWSLETTERS.

Are you a professional welder, or do you like to repair everyday items in your home garage? Perhaps you're a welding instructor looking for class resources or to share what your school has been working on?

Sign up for **PRO**, **DIY**, **Instructor** and **The Bevel** to receive new product updates, success stories, how-to and technical articles and videos, special offers, project ideas and other information tailored to your interests.

If you're an occupational health and safety professional, sign up for the **Welding Safety** newsletter to receive information on regulatory updates, industry news and solutions that can elevate productivity and compliance within the workplace.

Sign up now at [MillerWelds.com/newsletters](http://MillerWelds.com/newsletters)

# Welding Helmets

See page 112 for welding helmet accessories.



3 **YEAR** WARRANTY  
 Serious dependability backed with a three-year warranty (unless noted).

|                             | T94i™                          | T94™                               | Digital Infinity™         | Digital Elite™            | Digital Performance™   | Classic VSI™               | Classic VS             | Classic FS#10 Flip-Up |
|-----------------------------|--------------------------------|------------------------------------|---------------------------|---------------------------|------------------------|----------------------------|------------------------|-----------------------|
| Viewing Area                | 9 sq. in.                      | 9 sq. in.                          | 13.4 sq. in.              | 9.2 sq. in.               | 7.2 sq. in.            | 5.9 sq. in.                | 5.2 sq. in.            | 5.1 sq. in.           |
| Auto-Darkening              | Yes                            | Yes                                | Yes                       | Yes                       | Yes                    | Yes                        | Yes                    | Yes                   |
| ClearLight™ Lens Technology | Yes                            | Yes                                | Yes                       | Yes                       | Yes                    | –                          | Yes                    | –                     |
| AutoSense™                  | –                              | –                                  | Yes                       | Yes                       | –                      | –                          | –                      | –                     |
| Shades                      | Cut: 5-8<br>Weld: 8-13         | Cut: 5-8<br>Weld: 8-13             | Cut: 5-8<br>Weld: 8-13    | Cut: 5-8<br>Weld: 8-13    | Cut: 5-8<br>Weld: 8-13 | 8-13                       | Cut: 5-8<br>Weld: 8-13 | 10                    |
| Modes                       | Weld/Cut/X-Mode/<br>Flip grind | Weld/Cut/X-Mode/<br>External grind | Weld/Cut/X-Mode/<br>Grind | Weld/Cut/X-Mode/<br>Grind | Weld/Cut/<br>Grind     | Weld/X-Mode/<br>Flip grind | Weld/Cut/<br>Grind     | Weld/<br>Flip grind   |
| Integrated Grind Shield     | Yes                            | –                                  | –                         | –                         | –                      | Yes                        | –                      | Yes                   |
| Auto-on                     | Yes                            | Yes                                | Yes                       | Yes                       | Yes                    | Yes                        | Yes                    | Yes                   |
| Sensors                     | 4                              | 4                                  | 4                         | 4                         | 3                      | 3                          | 2                      | 2                     |
| TIG Rating                  | 3 amps                         | 3 amps                             | 5 amps/below              | 5 amps/below              | 5 amps                 | 5 amps/below               | 5 amps/below           | 20 amps               |
| Switching Speed             | 1/20,000 second                | 1/20,000 second                    | 1/20,000 second           | 1/20,000 second           | 1/20,000 second        | 1/20,000 second            | 1/23,000 second        | 1/3,600 second        |
| Digital Controls            | Yes                            | Yes                                | Yes                       | Yes                       | Yes                    | –                          | Yes                    | –                     |
| Premium Headgear            | Yes                            | Yes                                | Yes                       | Yes                       | Yes                    | –                          | –                      | –                     |
| InfoTrack™                  | Yes - 2.0                      | Yes - 2.0                          | Yes - 1.0                 | –                         | –                      | –                          | –                      | –                     |
| Weight                      | 26 oz. (737 g)                 | 21 oz. (599 g)                     | 23 oz. (652 g)            | 18 oz. (510 g)            | 17 oz. (482 g)         | 23 oz. (652 g)             | 16 oz. (454 g)         | 14 oz. (396 g)        |
| Warranty                    | 3 years                        | 3 years                            | 3 years                   | 3 years                   | 3 years                | 2 years                    | 3 years                | 2 years               |

See chart above for feature availability.

**Largest viewing area.** Digital Infinity™ welding helmets feature a 13.4-square-inch viewing area allowing for a wide range of view.

**ClearLight™ Lens Technology** provides high-definition optics for precision arc recognition.

**AutoSense™** reduces issues related to setting helmet sensitivity by allowing the welder to push and hold the AutoSense button to automatically set the helmet sensitivity for their environment.

**X-Mode™** Electromagnetically senses the weld to reduce sunlight interference and continuously detects the arc even if sensors are blocked.

**Premium headgear.** Features ample adjustability settings and enhanced support for the perfect fit, maximizing comfort.

**InfoTrack™ data monitoring technology** tracks arc time and features a clock. Version 2.0 adds arc count.

## T94™ Series Maximized comfort, visibility and productivity for the professional welder. See literature AY/41.1



**T94i™**  
260483

Industry's largest integrated grind shield (44 sq. in)



**T94™**  
260482

External grind control

**Matte silver finish** reflects ambient heat, keeping the user cooler.

**Four operating modes** for ultimate versatility: weld, cut, grind and X-Mode.™

**Half-shade settings** for precise lens adjustment.

**Simplistic digital lens interface** allows for easy adjustment with or without gloves.

**Shade 5.0 side windows** enhance peripheral vision, amplifying sense of surroundings.

**Chiseled shell design** provides optimal skin coverage while easily accommodating a Miller® Half Mask Respirator.

**Gen IV premium headgear** with four-point flexible design provides a secure fit, while avoiding major pressure points within the head, maximizing all-day wear. Customizable fit with seamless tilt, distance and tightness adjustments.

**InfoTrack™ 2.0** monitors arc time and arc count.

### Best-in-class comfort for all-day wearability

Lightweight, well-balanced design reduces neck torque, minimizing operator fatigue and strain, leading to an increase in comfort.



**4% LIGHTER** for reduced fatigue



**14% BETTER BALANCE** for elevated comfort



**17% LESS TORQUE** for reduced neck strain

Statistics above compare T94i to previous model.

### Helmet Lighting Accessory 281361

- Provides additional lighting in low-light environments for T94 welding helmets
- Includes two lights (one for each side) and all required mounting hardware





## Digital Infinity™ Series Largest viewing area maximizes visibility. See literature AY/42.0



**Black**  
280045

**Black Ops™**  
280047

**Departed™**  
280048

**Stars and Stripes™**  
280049

**Relic™**  
280051

**Imperial™**  
280053

## Digital Elite™ Series Industry-leading helmet provides high-performance versatility. See literature no. AY/43.0



**Black**  
281000

**Lucky's Speed Shop™**  
281001

**Stars and Stripes™ III**  
281002

**Inferno™**  
281003

**Vintage Roadster™**  
281004

**Raptor™**  
281007

**NEW!**  
**Gear Box™**  
281009

## Digital Performance™ Series See literature AY/44.0

Lightweight helmet with superior headgear for ultimate comfort.



**Black**  
282000

**Blue Rage™**  
282001

**'64 Custom™**  
282002

**Crusher™**  
282005

### Helmet Lighting Accessory 282013

- Provides additional lighting in low-light environments for most Miller® welding helmets including Titanium™, Infinity, Elite, Performance, Classic and MP-10
- Includes two lights (one for each side) and all required mounting hardware



## IMPROVED! Classic Series Helmets for the value-minded welder.

All VS models now feature ClearLight™ Lens Technology. See literature AY/45.5 (VS) and AY/45.0 (VSi and FS#10 Flip-Up)



**Black (VS)**  
287803

**Metalworks™ (VS)**  
287810

**Rise™ (VS)**  
287815

**Liberty™ (VS)**  
287820

**NEW!**  
**Metal Matrix™ (VS)**  
288519

**VSi™**  
260938

**FS#10 Flip-Up**  
263038

## MP-10™



**Black**  
238497

**Best-in-class traditional passive shade 10 lens helmet.**



## Welding Helmet Accessories



### Slotted Hard Hat Adapter 259637

- Compatible with most slotted hard hats. Helmet and hat not included



### Hard Hat Adapter 265315

- For T94™ welding helmets
- 222003 For Titanium™, Infinity™, Elite™, Performance™, Classic and MP-10™ welding helmets
- Compatible with most Fibre Metal and MSA hats. Other brands may fit depending on size and shape. Helmet and hat not included



### Magnifying Lens

- 212235 0.75 magnification
- 212236 1.00 magnification
- 212237 1.25 magnification
- 212238 1.50 magnification
- 212239 1.75 magnification
- 212240 2.00 magnification
- 212241 2.25 magnification
- 212242 2.50 magnification
- 4.25 x 2 x 5/23 inch lens for all Miller® helmets



### 2x4 Auto-Darkening Lens

- 770660 Shade 8
- 770659 Shade 9
- 770226 Shade 10
- 770961 Shade 11
- Fits all 2x4-inch windows
- Solar powered
- Two arc sensors
- Light state shade 3
- Two-year warranty



### Helmet Bib 253882

- Flame-resistant WeldX™ material provides additional neck coverage for the Infinity, Elite, Performance, Classic and MP-10 welding helmets



### Helmet Bib 279078

- Flame-resistant material provides additional neck coverage for the T94 welding helmets



### Helmet Cape 279080

- Flame-resistant material provides additional head and back-of-the-neck coverage for the T94 welding helmets



### Helmet Hook 251018

- Holds welding helmets, grinding shields or other helmets with a headgear
- Silicone strap secures the helmet in place



### Jobsite Tool Bag 228028

- Over twenty separate pockets
- Opening of 12 x 18.5 inches (305 x 470 mm)

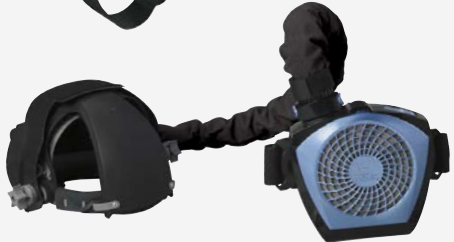

### CoolBelt™ Belt-Mounted Cooling System 245230

- Up to 17 degrees Fahrenheit cooler under the hood
- Provides all-day comfort through maximized airflow power
- Multiple airflow speeds eliminate stagnant air and reduce fogging
- Lightweight design extends wearability
- Compatible with Infinity, Elite, Performance, Classic and MP-10 welding helmets

## Weld-Mask™ See literature AY/40.0

Compact auto-darkening lenses allow users to weld in spaces where access with traditional welding helmets is limited. Close-fitting soft eye covering provides total darkness for precision welding. Face shield and flame-retardant head cover provide coverage for UV/IR rays and applications with limited spatter.



Weld-Mask

Weld-Mask 2



### Weld-Mask 2 Lighting Accessory 281188

- Snaps onto brow of Weld-Mask 2 model to provide additional lighting in low-light environments

### Weld-Mask Hard Hat Adapters 285757

- Snaps onto sides of most slotted hard hats to secure Weld-Mask

### Weld-Mask 267370

- Shades 5, 7, 9, 11 and 13 for use with MIG, TIG, stick, and gas welding and cutting
- Extremely lightweight (8 oz.), virtually eliminates neck strain

### Weld-Mask 2 280982

- Ideal for industrial or construction environments – can be worn under a hard hat with a Miller® Half Mask Respirator and select safety glasses
- Shades 5–13 for use with MIG, TIG, stick, and gas welding and cutting
- X-Mode™ electromagnetically senses the weld to reduce sunlight interference and continuously detects the arc even if sensors are blocked
- Wide, singular lens provides unmatched auto-darkening range of visibility

## Safety Glasses See literature AY/46.0



Classic



Slag



Spark



Spatter



Gen I

- Anti-fog coating and high-quality optics
- Form-fitting orbital eye coverage
- Shatterproof polycarbonate lenses
- Wrap-around designs meet ANSI side shield requirements
- ANSI Z87.1+ compliant
- I/O (indoor/outdoor) lenses feature light shading with a mirrored finish
- Shade 3 and 5 IR lenses are for cutting, brazing or soldering

### Safety and Cutting Glasses Chart

| Frame Style (Color) | Clear Lenses | I/O Lenses | Shade 3 Lenses | Shade 5 Lenses |
|---------------------|--------------|------------|----------------|----------------|
| Classic (Black)     | 272187       | –          | –              | –              |
| Spatter™ (Black)    | 272191       | –          | –              | –              |
| Spark™ (Black/Blue) | 272190       | –          | –              | –              |
| Slag™ (Black)       | 272201       | 272202     | –              | 272205         |
| Gen I (Black)       | –            | –          | 235662         | 235658         |



## Face Shield Series

See literature AY/46.5

**NEW!**



### Face Shield

**288269** Clear

**288274** Clear + Anti-Fog

**288270** Shade 3

**288273** Shade 5

- HDV technology for a sharp detailed view at any angle without distortion
- Impact-resistant shield for increased durability and protection
- Lightweight design for all-day wear and comfort
- Clear + Anti-Fog lens coating prevents fogging for enhanced visibility
- Shade 3 and 5 lenses provide protection for cutting, brazing or soldering applications
- Made of polycarbonate material that provides 99.9 percent UVA/UVB/UVC protection to help prevent eye damage
- ANSI Z87.1 compliant



**Halo Hard Hat Adapter**  
**222003**

**Slotted Hard Hat Adapter**  
**Clips (not shown) 259637**

## Welding Gloves

See literature AY/47.0

**Performance – unprecedented comfort and performance with exceptional dexterity and flexibility.**



### Heavy-Duty MIG/Stick

- Strategically placed patches on palm and back for extended glove life
- Double-layered insulated palm and back
- Pig grain leather palm provides extreme durability and protection



### MIG (Lined)

- Dual-padded palm
- Fleece-insulated palm, foam-insulated back
- Cow grain palm, pig split back and goat grain inner fingers provide exceptional dexterity and comfort



### TIG

- Completely unlined for heightened feel and dexterity
- Triple-padded palm for added comfort
- Goat grain leather offers superior flexibility and dexterity



### TIG/Multitask

- Dual-padded palm for added comfort
- Wool back provides ultimate insulation
- Goat grain leather offers superior flexibility and dexterity



### Metalworker

- Durable top grain leather and spandex back for enhanced durability and dexterity
- Neoprene wrist with hook-and-loop closure increases fit and support
- Padded, reinforced palm and thumb saddle for extended wear

**Classic – traditional design for the value-minded welder.**



### Heavy-Duty MIG/Stick

- Reflective insulation on back reduces heat impact
- Moisture-wicking fleece and foam insulation
- Pig grain palm, pig split back and cuff



### MIG (Pigskin)

- Reinforcement patches enhance durability
- Moisture-wicking fleece and foam insulation
- Pig split leather palm, back and cuff



### MIG (Cowhide)

- Reinforcement patches enhance durability
- Moisture-wicking fleece and foam insulation
- Cow split palm, pig split back and cuff



### TIG

- Thin internal padding for added comfort
- Unlined palm for precise dexterity
- Sheep grain palm, cow split back and cuff



### Work

- Dual-padded palm for added durability
- Fleece back provides ultimate insulation
- Cow grain leather offers superior durability and abrasion resistance

### Welding Glove Size Chart

\*All asterisked stock numbers are sold as one pair. All others are sold as six packs (six pairs).

| Performance Gloves   | Small  | Medium | Large  | X-Large | 2X-Large | Classic Gloves       | Medium  | Large   | X-Large |
|----------------------|--------|--------|--------|---------|----------|----------------------|---------|---------|---------|
| Heavy-Duty MIG/Stick | –      | –      | 263339 | 263340  | 269615*  | Heavy-Duty MIG/Stick | –       | 271877* | 271887* |
| MIG (Lined)          | –      | 263332 | 263333 | 263334  | 269618*  | MIG (Pigskin)        | –       | 279875* | 279876* |
| TIG                  | 263346 | 263347 | 263348 | 263349  | –        | MIG (Cowhide)        | –       | 271890* | 271891* |
| TIG/Multitask        | 263352 | 263353 | 263354 | 263355  | –        | TIG                  | 279897* | 279898* | 279899* |
| Metalworker          | –      | 251066 | 251067 | 251068  | –        | Work                 | 266041* | 266042* | 266043* |



## Welding Apparel

See literature AY/47.5



### Grain Leather Jacket (See size chart)

- Top-grain pigskin leather
- Expandable leather strategically placed for optimal mobility
- Flame-resistant inside cuff
- Satin lining
- Tapered, athletic cut
- Sewn entirely with Kevlar® thread, adding structural durability at each seam



### Split Leather Jacket (See size chart)

- Premium pig split leather
- Extended rear tail for additional protection
- Expandable leather strategically placed for optimal mobility
- Mesh lining
- Sewn entirely with Kevlar® thread, adding structural durability at each seam



### WeldX™ Jacket (See size chart)

- 7-ounce WeldX front and flame-resistant navy cotton back
- Lightweight exclusive material with extreme flame-resistant properties
- Vented back/extended rear tail
- Zipper closure with hook-and-loop fastened flap
- Chromium free for easy disposal



### Leather Bib/Apron 231125

- Attaches to combo jacket with snaps across the chest as a bib or along the bottom as an apron



### Combo Sleeves 231096

- Indura® flame-resistant cotton/top-grain leather
- 21-inch length



### Classic Cloth Sleeves 247148

- 18-inch length
- Fold-in sleeve snaps
- Upper arm elastic band



### Combo Jacket (See size chart)

- 9-ounce Indura® flame-resistant cotton (flame resistance guaranteed for life of jacket)
- Top-grain leather
- Pre-shrunk fabric



### Indura® Cloth Jacket (See size chart)

- 9-ounce Indura® flame-resistant cotton (flame resistance guaranteed for life of jacket)
- Pre-shrunk fabric



### Classic Cloth Jacket (See size chart)

- 9-ounce flame-resistant navy cotton
- Pre-shrunk fabric
- Fold-in sleeve snaps
- Finished hems and reinforced stitching



### Classic Cloth Apron 247149

- 35-inch length with accessible front pocket
- Adjustable drawstring ensures a good fit

### Welding Apparel Size Chart

| Apparel              | Small  | Medium | Large  | X-Large | 2X-Large | 3X-Large | 4X-Large | 5X-Large |
|----------------------|--------|--------|--------|---------|----------|----------|----------|----------|
| Grain Leather Jacket | —      | —      | 231090 | 231091  | 231092   | —        | —        | —        |
| Split Leather Jacket | 273212 | 273213 | 273214 | 273215  | 273216   | 273217   | 273218   | 273219   |
| WeldX Jacket         | 247114 | 247115 | 247116 | 247117  | 247118   | 247119   | 247120   | 247121   |
| Combo Jacket         | —      | 231081 | 231082 | 231083  | 231084   | —        | —        | —        |
| Indura Cloth Jacket  | —      | 258097 | 258098 | 258099  | 258100   | —        | —        | —        |
| Classic Cloth Jacket | 244749 | 244750 | 244751 | 244752  | 244754   | 244755   | 244756   | 244758   |



For more detailed information, visit

MillerWelds.com/arcstation



Count on Miller to design the perfect workbench to make welding projects faster and easier. The ArcStation is the first-ever, all-in-one workstation designed for welding and metalworking. It's versatile, affordable and just the right height to work comfortably. You can organize equipment, tools, and raw materials into one convenient workspace.

## ArcStation™ 60SX Fully Loaded

The 60SX Fully Loaded is perfect for the welder who needs a tough workbench for the fab shop or the home garage.



60SX Fully Loaded

**30 x 60 inch size tabletop** provides double the work surface of the 30FX.

**3/8-inch X-pattern steel tabletop** allows trouble-free clamping.

**Durable 1/8-inch steel frame with cross bar and heavy-duty tabletops** provide a sturdy area for welding or metalworking.

**Adjustable leveling feet** keep workbench rock-steady.

**Comes customized with a wide range of handy accessories** to make this the *ultimate* workbench (see at right for replacement accessories).

### ArcStation 60SX accessories

Miller® ArcStation accessories allow you to get the most out of your ArcStation.

- 1 6-inch X-clamp** 300613
- 2 Side Shelf** 300680
- 3 Tool Chest** with ball-bearing slides 300610
- 4 5-inch Quick-Remove Vise** with mount 300611
- 5 Weld Curtain** 300686
- 6 Casters** 300849



**Convenience Kit** 300614  
Includes the following:

- 7 Gun holder**
- 8 Tool holder**
- 9 Clamp bar**



Visit MillerWelds.com or your distributor for other Miller® options and accessories.

## ArcStation™ 30FX

When portability or space-savings is a concern, the ArcStation 30FX is your solution.



30FX shown with two 6-inch X-clamps (sold separately).

**Wheels, handle, and fold-up design** make unit easy to take to the jobsite or move around the shop.

**Compact size** makes storing unit a breeze. Unit folds down to 6 x 29 x 48 inches (152 x 737 x 1219 mm).

**30 x 30 inch size tabletop** provides plenty of work surface.

**3/16-inch X-pattern steel tabletop** allows trouble-free clamping.

**1.5-inch diameter steel tube frame** provides strength and durability.

**Includes removable gun holder.**

**Add optional 6-inch X-clamp (300613)** to make this the *ultimate* portable workbench.

| Model/Stock Number                | Steel Top  | Load Capacity      | Dimensions                              | Weight           |
|-----------------------------------|--|--------------------|---|------------------|
| <b>60SX Fully Loaded (951793)</b> | (1) 29 x 29 x 3/8 in. solid, (1) 29 x 29 x 3/8 in. X-pattern | 1,000 lb. (454 kg) | 35 x 58 x 29 in. (889 x 1,473 x 737 mm) | 318 lb. (144 kg) |
| <b>30FX (300837)</b>              | (1) 29 x 29 x 3/16 in. X-pattern                             | 500 lb. (227 kg)   | 35 x 29 x 35 in. (889 x 737 x 889 mm)   | 74 lb. (34 kg)   |



From our FREE OpenBook™ training software, to our AugmentedArc® augmented reality welding system and LiveArc™ welding performance management system, we provide solutions to meet all of your welding training needs.

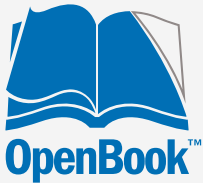

OpenBook provides FREE interactive online training resources, educational materials and tracking tools. These materials allow welding instructors to assign and deliver welding content, create quizzes, download welding labs, monitor student participation, and assess and report student progress and performance. Visit [OpenBook.MillerWelds.com](http://OpenBook.MillerWelds.com) for details.

### Customize your classroom

- Implement materials that fit your curriculum and learning objectives, including:
  - e-Learning modules
  - Weld lab activities
  - Course builder
  - Quiz builder
  - Lab builder
  - Customizable certificates of completion
- Miller® and Hobart® pre-defined courses with certificates of completion
- Track individual student progress
- All material aligns with AWS standards

### Motivate and engage students

- Interactive, stimulating learning includes videos and activities
- Quick, digestible segments
- Mobile friendly
  - Easy to access homework from anywhere
  - Students can check grades and status
- Ideal for high school and post-secondary welding programs

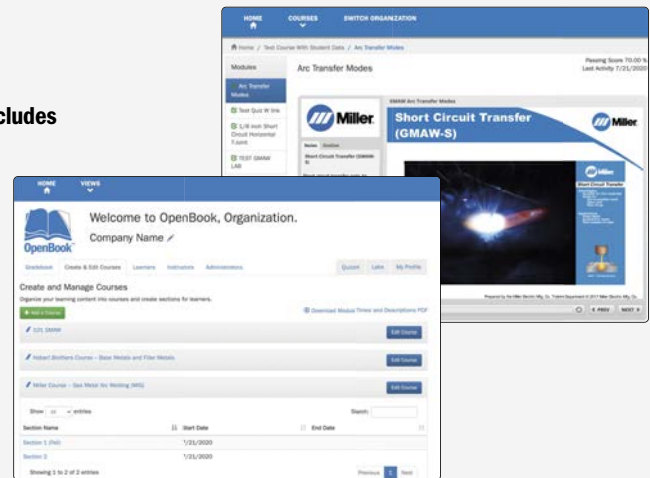

## AugmentedArc® Augmented Reality Welding System

## LiveArc™ Welding Performance Management System



The AugmentedArc augmented reality welding system allows students and trainees to experience a highly realistic multiprocess welding simulation — and then seamlessly transition to the industry's most complete live arc experience in the LiveArc welding performance management system.

### Delivering unbeatable advantages

- Optimize instructor efficiency
- Deliver real-time feedback
- Reduce overall training time
- Assess weld operator skills and performance
- Minimize material cost
- Enhance job candidate recruiting and screening
- Build a larger, more-skilled welding workforce

## AugmentedArc® Augmented Reality Weld Training

See literature TS/2.0

**The highly realistic multiprocess welding simulation solution for classroom training.**

Only available at approved distributors!



Lightweight, balanced AR welding helmet with large viewing area provides a realistic augmented reality environment.

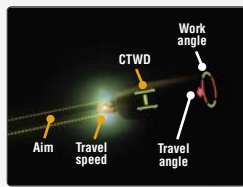
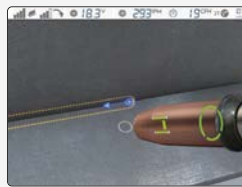

**Optimize instructor efficiency by using the Teacher software** to create a virtual classroom with customized curriculum, quizzes and weld exercises.

**Real-time feedback** is provided on users' technique to help correct errors, reinforce proper welding practices and accelerate skill advancement prior to actual live arc welding in a lab.

**Reduce overall training time.** Compared to traditional methods, AugmentedArc significantly reduces the amount of time needed to teach students.

**Minimize material cost** by saving wire, gas and workpieces in this simulation environment, while allowing students to define their welding skills before live arc welding.

**Build a larger, more-skilled welding workforce** when computer-savvy individuals are drawn to welding education programs that increase their success.

### AugmentedArc system comes complete with

- AugmentedArc simulator
- Teachers software
- Black Infinity™ AR helmet with premium headgear
- Internal router
- MIG gun with AR nozzle
- SMAW stinger
- TIG torch with AR nozzle
- Two electrode/filler rods with AR tips
- Work stand for out-of-position applications
- Five workpieces: t-joint, butt joint, lap joint, pipe-to-plate and butt pipe

### Optional components



- **TIG Foot Pedal Kit 286033**  
Includes TIG foot pedal, connection cable and adapter cable
- **AugmentedArc Controller 301395**  
For multiple system connectivity
- **Heavy-duty Transportation Cases 951775**  
Protects complete system during transportation or storage – one case holds the simulator and the other holds accessories

| Stock Number  | Input Power        | Voltage/Amperage Selection   | Welding Positions | Polarity Selection | Shielding Gas Selection   | Wire Speed Selection                             | Base Material Selection                     | Workpiece Selection                     | Stick Electrode Selection | Diameter Selection   | Simulator Dimensions   | Net Weight  |
|---|--------------------|--|-------------------|--------------------|---|--|---|---|---------------------------|--|--|---|
| (951823)<br>Only available at approved distributors | 115 V, 15 A, 60 Hz | GMAW: 10-38 V<br>50-425 A<br>FCAW: 10-38 V<br>50-425 A<br>SMAW: 50-425 A<br>GTAW: 50-425 A | 1F-4F<br>1G-6G    | DCEP<br>DCEN<br>AC | CO <sub>2</sub><br>Argon O <sub>2</sub><br>Argon CO <sub>2</sub><br>Argon | GMAW/FCAW:<br>50-1,000 ipm<br>(1.27-25.4 m/min.) | Carbon steel<br>Stainless steel<br>Aluminum | 1/8, 1/4, 3/8 in.<br>(3.2, 6.4, 9.5 mm) | E7018<br>E6010<br>E6013   | Solid wire: .030, .035, .045 in.<br>(0.8, 1.0, 1.2 mm)<br>Stick electrode: 1/8, 3/32, 5/32 in.<br>(2.5, 3.25, 4.0 mm)<br>Filler rod: 5/64, 3/32 in.<br>(2.0, 2.4 mm) | H: 21 in.<br>(533 mm)<br>W: 9.38 in.<br>(238 mm)<br>D: 17.25 in.<br>(438 mm) | Simulator:<br>20.7 lb.<br>(9.4 kg)<br>Helmet:<br>1.97 lb.<br>(0.9 kg) |

## LiveArc™ Welding Performance Management System

See literature TS/1.0

Only available at approved distributors!

GMAW/FCAW/SMAW system shown.



**The reality-based recruiting, screening, training, and re-qualification solution for industrial, manufacturing and educational markets.**

**Better and more cost-effective training with faster results.** Benefit from both weld simulation and the real-world experience of live arc welding with instant, valuable feedback on welding technique to quickly help build skills.

**Motion-tracking technology** measures the operator's adherence to preset technique parameters. Cameras track the movement of LEDs embedded in the MIG SmartGun and SMAW SmartStinger during pre-weld simulations and live welds; the system then delivers visual feedback on the operator's performance via the LiveArc system's main display.



### LiveArc GMAW/FCAW system comes complete with

- Computer with Intel core i7, 128 GB SSD, fanless cooling, and HDMI port for connection to most secondary monitors (not included)
- 21.5 HD LCD touch screen monitor
- SmartGun with 15 ft. (4.6 m) cable
- Calibration tool
- Two table clamps
- Removable arm extension with C-clamp assembly for out-of-position right- and left-hand applications
- Extra Bernard® consumables

### LiveArc GMAW/FCAW/SMAW system includes above plus

- SmartStinger with 12 ft. (3.7 m) cable
- 15 ft. (4.6 m) Dinse-style cable
- Router box
- Software update for SMAW applications

| Stock Number  | Input Power   | Processes                               | Positions       | Multi-Pass   | Rated Output   | Electrode Diameter  | Dimensions   | Net Weight   |
|---|---|---|-----------------|--|--|---|--|--|
| (907714) GMAW/FCAW system<br>(907714001) GMAW/FCAW/SMAW system<br>Only available at approved distributors | 120 V, 60 Hz<br>Compatible with Miller® power sources | GMAW, GMAW-S,<br>GMAW-P, FCAW-G<br>SMAW | 2F-4F,<br>1G-4G | Groove and fillet up to 1 in. (25 mm) plate<br>Limited groove applications | SmartGun: 400 A at 60% duty cycle (mixed gases)<br>SmartStinger: 250 A at 60% duty cycle | SmartGun: Up to 5/64 in. (2.0 mm)<br>SmartStinger: Up to 1/8 in. (3.2 mm) | H: 77.5 in. (1,969 mm)<br>W: 46 in. (1,168 mm)<br>D: 31 in. (787 mm) | GMAW/FCAW system:<br>480 lb. (218 kg)<br>GMAW/FCAW/SMAW system: 527 lb. (239 kg) |



## Automated MIG 118

Cable Connectors and Adapters 118/125

Carts, Cylinder Racks and Running Gear 118-120

Coolmate Coolant Systems 119

Engine Drive Accessories 120-121

- Big Blue Accessories ▪ Blue Star and Fusion Accessories
- Bobcat and Trailblazer Accessories
- Generator Accessories ▪ Protective Covers
- Remote Output Panel Kit ▪ Trailers

## Load Banks 121

MIG Accessories 121

- Machine and Gun Accessory Kits ▪ Protective Covers

Plasma Cutter Accessories 122

- Automation Kits ▪ Cables and Cable Covers
- Cutting Guides ▪ Filters ▪ Plugs and Cords
- Protective Case ▪ Torches

Process Selector Control/Polarity Switch 123

Remote Controls and Wireless Remote Controls 123-125

## Stick Accessory Kits 123

Submerged Arc Accessories 123

- Cables ▪ Torch Accessories
- Wire Drive Assembly Accessories

TIG Accessories 124-125

- Kits ▪ Protective Case/Covers ▪ Remote Controls
- Torch and Weld Cable Connectors

Wire Feeder Accessories 126

- Extension Cables (14-pin) ▪ Power Supply Adapter
- Spool Adapter ▪ Spool Gun Controls and Kits
- Turntable Assembly ▪ Wire Straightener

## Automated MIG

For adapters and drive motors, visit MillerWelds.com.



### Coolant Flow Switch 195461

For water-cooled guns. To ensure coolant is flowing in the system. A lack of coolant flow may cause damage to water-cooled guns.

Module allows wiring into the peripheral connector port. 50-foot (15.2 m) cable with connector and separate shell connector for simple modification to desired length in the field. Quarter-turn quick connection.

## Cable Connectors and Adapters

Also see Torch and Weld Cable Connectors in TIG Accessories on page 125.

For AlumaPower 350 MPa, Invision 352 MPa, XMT 350, CST, Syncrowave, Maxstar and Dynasty. These power sources are equipped with Dinse- or Tweco-style connectors for secondary connections.

### Dinse-Style Connector Kits

**042418** Accepts #4 to #1/0 AWG cable

**042533** Accepts #1/0 to #2/0 AWG cable

Kits include one male Dinse-style plug which attaches to the work and/or weld cables and plugs into the female Dinse-style receptacles on the power source.

### Extension Kit for Dinse-Style Cable Connectors

**042419** Accepts #4 to #1/0 AWG cable

Used to adapt or extend weld and/or work cables. Kit includes one male Dinse-style plug and one in-line female Dinse-style receptacle.

### Extensions for Dinse-Style Cable Connectors

**134460** Male Dinse-style plug

**136600** Female Dinse-style receptacle

Used to adapt or extend weld and/or work cables. Accepts #1/0 to #2/0 AWG cable.



### Tweco®-Style Connector 191981

Accepts #1/0 to #2/0 AWG

cable. Kit includes one male Tweco-style plug which attaches to the work and/or weld cables and plugs into the female Tweco-style receptacles on the power source.



### Dinse/Tweco® Adapter 042465

**Dinse/Cam-Lok Adapter 042466**

One-piece adapter with male Dinse-style

plug (to power source) on one end and female Tweco- or Cam-Lok-style receptacle (for weld cable connection) on other end.



### Tweco®/Dinse Adapter 210061

One-piece adapter with male Tweco-style plug (to power source) on one end and female Dinse-style receptacle (for weld cable connection) on other end.

## Carts, Cylinder Racks and Running Gear

Also see Engine Drive Accessories on page 120.



### Feeder Cart 142382

A low-profile, creeper cart which allows the operator to easily move the feeder around the work area.



### Universal Cart and Cylinder Rack 042934

For Invision 352 MPa, XMT 350, CST, Diversion, Maxstar 210/280 and Dynasty 210/280.

Also accommodates a single gas cylinder up to 56 inches (1,422 mm)

high measuring 6 to 9 inches (152 to 229 mm) in diameter. Provides storage for auxiliary items such as electrodes, helmets and gloves.



### Running Gear/Cylinder Rack 301239

For Millermatic 141/211, Multimatic 200/215 and Diversion. Heavy-duty construction with 8-inch rubber rear wheels,

convenient front handles, cable holders and plastic consumable box. For gas

cylinders no greater than 7 inches (178 mm) in diameter or 65 pounds (29.5 kg) in weight.



### Dual Cylinder Rack Cart 951770

For Millermatic 141/211, Multimatic 200/215/220

AC/DC and Diversion. Similar to Running Gear/Cylinder Rack, but with dual-cylinder rack and a bracket that holds a variety of tools. Dual

Cylinder Rack Conversion Kit and Tool Holder (301454) is also available separately for use with Running Gear/Cylinder Rack 301239 above.



### Dual EZ-Change™ Low Cylinder Rack with Elevated Gun and Cable Rack 300337

For Millermatic 252 and Syncrowave 210. Allows operators to easily roll cylinders on and off the rack with no lifting and keeps cables off the floor and tangle free. Elevated Gun and Cable Rack (300335)

is also available separately for use with factory-installed single-cylinder rack.



### EZ-Latch™ Single Cylinder Running Gear 301449

For Millermatic 255 and Multimatic 235/255.

Running gear with a single-cylinder rack and storage compartment. Machine is secured to cart by latches that rotate to disengage machine for easy portability.



### EZ-Latch™ Dual Cylinder Rack Running Gear 951769

For Millermatic 255 and Multimatic 235/255.

Similar to EZ-Latch Single Cylinder Running Gear, but with a dual-cylinder rack and elevated gun/cable rack to keep cables off the floor and tangle free. EZ-Latch Dual Cylinder Rack with

Elevated Gun and Cable Rack (301481) is also available separately for use with EZ-Latch Single Cylinder Running Gear 301449 above.



### Dual Cylinder Rack 195299

For Millermatic 350P/350P Aluminum. Replaces single-cylinder rack.



**MIGRunner™ Cart 195445**  
For AlumaFeed system or Invision and XMT with single-wire feeders. Small footprint and easily maneuverable, with a dual-cylinder rack low enough that you do not have to lift bottles. Durable, heavy-duty ergonomic handles are designed for comfort.



**Deltaweld 350/500 Running Gear 301523**  
For Deltaweld 350/500. Features small footprint, dual-cylinder rack, chains for gas cylinders, ergonomic handle design and lockable front casters with two torch holders, and storage area below.



**2-Wheel Trolley Cart 300971**  
For Maxstar 210/280 and Dynasty 210/280 with or without Coolmate 1.3. Easy-to-maneuver two-wheel cart features single-cylinder rack, chain for cylinder, straps (quick and easy to detach and carry machine), cable holders, torch holder, storage area, and filler rod storage area.



**Running Gear Cylinder Rack 300408**  
For Invision, XMT with single- or dual-wire feeders, and Dimension 650. Holds two large gas cylinders and has gun cable hangers and a consumable drawer in front. A convenient handle allows the cart to be pulled easily through doorways. Power source and single- or dual-wire feeders can be mounted to cart and secured.



**Continuum Running Gear/Cylinder Rack 301264**  
For Continuum. Small footprint and easily maneuverable, with cylinder rack low enough that you do not have to lift bottles.



**Small Runner™ Cart 301318**  
For Maxstar 210/280 and Dynasty 210/280 with or without Coolmate 1.3. Cart features single-cylinder rack, foot pedal holder, two cable/torch holders and two TIG filler holders.



**Runner™ Cart 300244**  
For Maxstar 400/800 and Dynasty 400/800 with or without Coolmate 3.5. Cart features single-cylinder rack, foot pedal holder, three cable/torch holders and two TIG filler holders.

## Coolmate™ Coolant Systems

See literature AY/7.2



Coolmate 1.3

Coolmate 3

Coolmate 3.5

Coolmate 4

**Coolmate 1.3 300972 120 V**  
For Maxstar 210/280 and Dynasty 210/280. Light industrial, 1.3-gallon cooler designed for water-cooled torches on power sources rated up to 280 amps\*.

**Coolmate 3 043007 120 V 043008 240 V**  
Economical, 3-gallon cooler designed for water-cooled torches rated up to 500 amps\*.

**Coolmate 3.5 300245 120 V**  
For Maxstar 400/800 and Dynasty 400/800. Industrial, 3.5-gallon cooler designed for water-cooled torches rated up to 600 amps\*.

**Coolmate 4 042288 120 V**  
Best performer in its class – industrial, 4-gallon cooler designed for water-cooled torches rated up to 600 amps\*.

\*May vary with torch design and cable length. Miller® coolant systems are backed by the best warranty in the industry – one full year.

### Coolant

Sold in multiples of four in 1-gallon recyclable plastic bottles. Miller® coolants contain a base of ethylene glycol and deionized water to protect against freezing to -37 degrees Fahrenheit (-38°C) or boiling to 227 degrees Fahrenheit (108°C).



#### Low-Conductivity Coolant (clear, pre-mixed) 043810

For TIG and MIG applications. NOT for use in push-pull systems or systems where aluminum is in coolant path/circuit.

#### Aluminum-Protecting Coolant (green, pre-mixed) 043809

Primarily used in push-pull systems where aluminum is in coolant path/circuit and high frequency is NOT used.

| Model               | Motor Input Voltage | Maximum Current Draw         | Maximum Cooling Capacity                              | IEC Cooling Capacity                               | Tank Capacity     | Dimensions  | Net Weight     |
|---------------------|---------------------|------------------------------|---|--|-------------------|---|----------------|
| <b>Coolmate 1.3</b> | 115 V, 60 Hz        | 4.7 A (60 Hz)                | 3,400 W (11,600 Btu/hr.)<br>3.8 qt./min. (3.6 L/min.) | 1,330 W (4,540 Btu/hr.)<br>1.1 qt./min. (1 L/min.) | 1.3 gal. (4.9 L)  | H: 11.25 in. (286 mm)<br>W: 10.38 in. (264 mm)<br>D: 24 in. (610 mm)    | 43 lb. (20 kg) |
| <b>Coolmate 3</b>   | 115 V, 50/60 Hz     | 5.9 A (50 Hz), 4.7 A (60 Hz) | 3,820 W (13,000 Btu/hr.)<br>4.2 qt./min. (4.0 L/min.) | 1,420 W (4,840 Btu/hr.)<br>1.1 qt./min. (1 L/min.) | 3 gal. (11.4 L)   | H: 13.25 in. (337 mm)<br>W: 12.25 in. (311 mm)<br>D: 23.25 in. (584 mm) | 40 lb. (18 kg) |
|                     | 230 V, 50/60 Hz     | 2.5 A (50 Hz), 3.0 A (60 Hz) |   |  |                   |   |                |
| <b>Coolmate 3.5</b> | 115 V, 50/60 Hz     | 5.9 A (50 Hz), 4.7 A (60 Hz) | 4,140 W (14,000 Btu/hr.)<br>5.0 qt./min. (4.7 L/min.) | 1,660 W (5,660 Btu/hr.)<br>1.1 qt./min. (1 L/min.) | 3.5 gal. (13.2 L) | H: 11.75 in. (298 mm)<br>W: 15.75 in. (400 mm)<br>D: 26 in. (660 mm)    | 64 lb. (29 kg) |
| <b>Coolmate 4</b>   | 115 V, 50/60 Hz     | 5.9 A (50 Hz), 4.7 A (60 Hz) | 5,500 W (18,000 Btu/hr.)<br>5.9 qt./min. (5.6 L/min.) | 1,780 W (6,070 Btu/hr.)<br>1.1 qt./min. (1 L/min.) | 4 gal. (15 L)     | H: 16.25 in. (413 mm)<br>W: 15.25 in. (387 mm)<br>D: 18.75 in. (476 mm) | 38 lb. (17 kg) |

## Engine Drive Accessories

Also see Trailers on page 121.

### Big Blue Accessories



**Cable Holder 043946**  
For Big Blue 500 Pro/600 Series/800 Series.



**Vandalism Lockout Kit 399802 Field**  
For Big Blue 500 Pro/600 Series. Lockable hinged steel panels cover and protect name plate gauges and ignition switch (padlock included). Also includes engine compartment door lock and key.

### Blue Star and Fusion Accessories



**Lifting Eye 195353**  
For Fusion and Blue Star.



**Running Gear 301246**  
For Fusion and Blue Star. Compact and balanced, lightweight wheelbarrow-style running gear provides easy on-site mobility.

### Bobcat and Trailblazer Accessories (Gas/LP)



**Multi-Terrain Running Gear 301460** Never Flat™ tires  
For Bobcat 200 Air Pak.  
**300913** Inner tubes  
**300914** Never Flat™ tires  
For gas/LP Bobcat and Trailblazer (except Air Pak models).

Includes two heavy-duty 15-inch tires, two 8-inch rubber swivel casters and a heavy-duty handle. Recommended for all surfaces and applications and is easy to move around the jobsite.



**Off-Road Running Gear 300909** Inner tubes  
**300910** Never Flat™ tires  
For gas/LP Bobcat and Trailblazer (except Air Pak models). Includes four heavy-duty 15-inch tires and a rugged handle to provide maximum maneuverability.



**Off-Road Running Gear with Protective Cage and Never Flat™ Tires 300912**  
For gas/LP Bobcat and Trailblazer (except Air Pak models). Running gear and rugged cage with cable holders protects your investment and is easy to move around the jobsite.



**Protective Cage with Cable Holders 300921** For gas/LP Bobcat and Trailblazer (except Air Pak models).  
**300473** For Trailblazer 302 Air Pak.

Rugged cage with cable holders protects your investment. Works with Running Gear, Gas Cylinder Mounting Assembly or LP Tank Mounting Assembly.



**Gas Cylinder Mounting Assembly 300918**  
For gas Bobcat and Trailblazer (except Air Pak models). Designed for use with Running Gear, Protective Cage, or by itself. Includes base tray with bottle bracket, vertical support rack and safety chain.

Note: Not for use with LP Tank Mounting Assembly. Not recommended for use with Protective Cover.



**Hose and LP Tank Mounting Assembly 300917**  
For LP Bobcat and Trailblazer. Designed for use with Running Gear, Protective Cage, or by itself. Includes bracket and clamp to mount 33- and 43-pound tanks horizontally, and hose with fittings to converter.

Note: Cannot be used with Gas Cylinder Mounting Assembly. Not recommended for use with Protective Cover.



**Remote Oil Drain and Filter Kit 300923 Field**  
For gas Bobcat and Trailblazer (except Air Pak models). Front mount for Kohler engines makes servicing easy when engine drive is mounted in tight spots.

### Bobcat and Trailblazer Accessories (Diesel)



**All-Purpose Running Gear with Never Flat™ Tires 300477**  
For diesel Bobcat 260 and Trailblazer 325. Includes two heavy-duty 15-inch tires, two 8-inch rubber swivel casters and a heavy-duty handle. Recommended for

all surfaces and applications and is easy to move around the jobsite.



**Protective Cage with Cable Holders 195331**  
For diesel Bobcat 260 and Trailblazer 325. Rugged cage with cable holders protects your investment. Works with Running Gear, or with trailer.

Note: Not for use with Protective Cover.

## Generator Accessories



**Twist Lock Adapter Cord 301489**  
For Fusion. L14-30R to NEMA 6-50R. Adapts engine drive 120/240-volt twist lock plug to common Millermatic and Spectrum 240-volt plug.



Female Receptacle

**Full KVA Adapter Cord 300517**  
For Bobcat, Trailblazer and Big Blue models. NEMA 14-50P to NEMA 6-50R. Adapts engine drive 120/240-volt plug to common Millermatic and Spectrum 240-volt plug.



**Full KVA Plug Kit 119172** 1-phase, 120/240 V, 50 A plug (NEMA 14-50P). For Bobcat, Trailblazer and Big Blue models.  
**165963** 3-phase, 480 V, 30 A plug (NEMA L16-30P). For Bobcat 3 Phase.  
**254140** 3-phase, 240 V, 50 A plug (NEMA 15-50P). For Big Blue 500 Pro/600 Series/800 Series.

## Protective Covers



Protective covers (300919) and (195301) shown.

### Protective Covers

Heavy-duty, water- and mildew-resistant covers protect and maintain the finish of the welder.  
**301245** For Fusion and Blue Star.  
**301475** For gas Bobcat 200 Air Pak **without** Running Gear.  
**301476** For gas Bobcat 200 Air Pak **with** Running Gear.  
**301531** For diesel Bobcat 200 Air Pak **without** Running Gear.  
**301532** For diesel Bobcat 200 Air Pak **with** Running Gear.  
**300919** For gas Bobcat and Trailblazer (except Air Paks) **without** Protective Cage or Running Gear.  
**300920** For gas Bobcat and Trailblazer (except Air Paks) **with** Protective Cage or Running Gear.  
**301099** For diesel Bobcat 260 and Trailblazer 325 **without** Protective Cage or Running Gear.  
**300379** For Trailblazer 302 Air Pak.  
**195301** For Big Blue 400 Pro/400 PipePro/450 Duo CST.  
**301495** For Big Blue 500 Pro/600 Pro with Kubota.  
**301113** For Big Blue 600 Air Pak/800 Series with Deutz.

## Remote Output Panel Kit



**Remote Output Panel Kit 951850**  
For Bobcat, Trailblazer and Big Blue (except 450 Duo CST) models. Kit allows you to locate your welder/generator's output panels at the point of use, so you don't need to climb onto the truck as often to make connections.

## Trailers

See literature AY/20.0



### HWY-Mid Frame Trailer 301438

For Bobcat, Trailblazer and Big Blue 400 Pro/400 PipePro/450 Duo CST. A 1,424-pound (646 kg) capacity highway trailer with welded steel tubing frame, heavy-duty axle with roller bearing hubs and leaf-spring suspension. Includes jack stand, fenders, lights, and dual hitch with 2-inch (50 mm) ball hitch and 3-inch (76 mm) lunette eye.

### HWY-225 Trailer 301338

For Big Blue models. A 2,700-pound (1,225 kg) capacity highway trailer with welded steel tubing frame, heavy-duty axle with roller bearing hubs and leaf-spring suspension. Includes jack stand, fenders, lights, and dual hitch with 2-inch (50 mm) ball hitch and 3-inch (76 mm) lunette eye.

### 4 West Four-Wheel Steerable Off-Road Trailer 042801

For Big Blue 500 Pro/600 Series/800 Series. A heavy-duty 2,550-pound (1,157 kg) capacity trailer designed for use in mines, quarries and other rough terrain. Has narrow 22-foot (6.7 m) turning radius. Includes 3-inch (76 mm) lunette eye, universal hitch and safety chains.

Note: Trailers are shipped unassembled. \*\*Width at outside of fenders. \*\*Does not include tongue.

## Trailer accessories

### Fender Kit 301439

For HWY-Mid Frame and HWY-225. Replacement fenders.

### Dual Hitch 301441

For HWY-Mid Frame and HWY-225. Combination 2-inch (50 mm) ball hitch and 3-inch (76 mm) lunette eye in one reversible assembly.



### Cable Tree 043826

For HWY-Mid Frame and HWY-225. Provides an area to conveniently wrap weld cables and extension cords.



### 2-In-1 Document/Fire Extinguisher Holder 301236

For HWY-Mid Frame and HWY-225. Stores documents and holds a 5-pound fire extinguisher.

Note: Holder shown mounted on trailer. Fire extinguisher not included.



| Model         | Gross Axle Weight Rating     | Gross Vehicle Weight Rating | Net Payload          | Height of Bed      | Road Clearance   | Track (Center to Center of tires) | Standard Tires (Standard Rating or P-size Rating) | Dimensions   | Net Weight       |
|---------------|------------------------------|-----------------------------|----------------------|--------------------|------------------|-----------------------------------|---|--|------------------|
| HWY-Mid Frame | 1,605 lb. (728 kg)           | 1,424 lb. (646 kg)          | 1,424 lb. (646 kg)   | 19.5 in. (495 mm)  | 8 in. (203 mm)   | 46 in. (1,168 mm)                 | ST175/80D-13 Load Range C                         | L: 101 in. (2,565 mm)<br>W: 55 in. (1,397 mm)*     | 181 lb. (82 kg)  |
| HWY-225       | 3,500 lb. (1,588 kg)         | 2,999 lb. (1,360 kg)        | 2,700 lb. (1,225 kg) | 19 in. (483 mm)    | 7.5 in. (191 mm) | 50 in. (1,270 mm)                 | ST175/80R-13 Load Range D                         | L: 105.5 in. (2,680 mm)<br>W: 56.5 in. (1,435 mm)* | 280 lb. (127 kg) |
| 4 West        | 2,000 lb./axle (907 kg/axle) | 3,000 lb. (1,361 kg)        | 2,550 lb. (1,157 kg) | 21.25 in. (540 mm) | 8 in. (203 mm)   | 55.25 in. (1,403 mm)              | B78-13  | L: 91 in. (2,311 mm)**<br>W: 61.25 in. (1,556 mm)  | 420 lb. (191 kg) |

## Load Banks



### LBP-350 043329

Designed to provide an adjustable load for troubleshooting or calibrating welding power sources or generators. Standard equipment

includes analog meters for both AC and DC output with jacks for external metering connections. It comes with a 13-foot (4 m) 115-volt power cord and has seven 50-amp load switches, providing a maximum capacity of 350 amps.



### Welding Power Load Bank 902804

Designed to load test the output of transformer-type, engine- or motor-driven generator welding power sources. This unit can be used to test AC or DC welder outputs, and to demonstrate welding equipment to customers.

## MIG Accessories

### Machine and Gun Accessory Kits



MIG kit with Dinse-style connectors for single-wire feeders shown.

### Industrial MIG 4/0 Kit (with lugs)

**300390** For single-wire feeders.

**300957** For dual-wire feeders.

Consists of flowmeter regulator with 10-foot (3 m) gas hose, 10-foot (3 m) 4/0 feeder weld cable with lugs, and 15-foot (4.6 m) work cable with 600-amp C-clamp. Dual kit comes with two flowmeter regulators and gas hoses.

### Industrial MIG 4/0 Kit (with Dinse-style connectors)

**300405** For single-wire feeders.

**300956** For dual-wire feeders.

Same as above except weld and work cables have Dinse-style connector on one end instead of lug.

### MIGmatic™ M-Series Gun Consumable Kits

**234607** .023 in. (0.6 m) wire

**234608** .030 in. (0.8 m) wire

**234609** .035 in. (0.9 m) wire

For M-100/M-150 guns. Kits include ten contact tips, one tip adapter, one standard nozzle and a consumable storage box.

## Protective Covers



### 301262

For Millermatic 141/211 and Multimatic 215.



### 301524

For Multimatic 220 AC/DC.



### 301521

For Millermatic 255 and Multimatic 235/255. Features side pocket.



### 195142

For Millermatic 252/350P/350P Aluminum and Syncrowave 210. Features side pocket.

## Plasma Cutter Accessories

### Automation Kits



Spectrum 875 Auto-Line automation kit shown.

**Automation Kits for Spectrum 875 and 875 Auto-Line 301156** For Spectrum 875.

**301157** For Spectrum 875 Auto-Line.

Upgrades hand-held torch packages to add machine torch capabilities. Automation kit for Spectrum 875 Auto-Line (**301157**) includes a remote pendant control for manual on/off. Machine torches are NOT included in kits and must be ordered separately.

### Cables and Cable Covers



#### Flexible Work Cable

**234838** 20 ft. (6.1 m)

**234930** 50 ft. (15.2 m)

Work cable with quick connect and heavy-duty clamp.



#### Cable Covers

**239642** 20 ft. (6.1 m)

**231867** 25 ft. (7.6 m)

**231868** 50 ft. (15.2 m)

### Cutting Guides

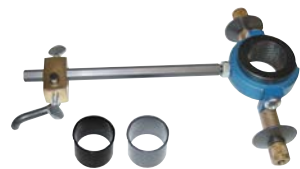

#### Plasma Circle-Cutting Guides 253055

For XT30/XT40/XT60 torches. Cut straight lines or circles up to 12 inches in diameter.

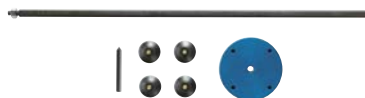

#### Suction/Magnetic Pivot Base 195979

Add this to your cutting guide for convenient attachment to all flat surfaces. The extended arm accommodates holes up to 30 inches in diameter.



#### Plasma Standoff Roller Guide 253054

Helps maintain recommended standoff distance to maximize cutting performance and improve tip life.

### Filters



#### In-Line Air Filter Kit 228926

For Spectrum 375 X-TREME/625 X-TREME/875/875 Auto-Line. Mounts to back of the plasma cutter. Includes male and female 1/4-inch NPT quick-disconnect fittings and hose for easy on/off connection. The replaceable filter element (**228928**) filters for removal of 99.9 percent of water, dirt and oil.



#### RTI Filter and Bracket 300491

For Spectrum 875/875 Auto-Line. Can be mounted on plasma cutter or on wall. Install as close as possible to point of air consumption. The replaceable filter element (**212771**) filters as small as one micron for removal of 99.9 percent of water, dirt and oil.

### Plugs and Cords

#### MVP™ Plugs



#### 219258

For 6-50P power cable (230/240 V, 50 A).



#### 219261

For 5-15P power cable (115/120 V, 15 A).



#### 219259

For 5-20P power cable (115/120 V, 20 A).

For Spectrum 375 X-TREME, Millermatic 211, Multimatic 200/215/220 AC/DC, Thunderbolt 160, Diversion, Syncrowave 210 and Fusion. Allows connection of machine to 115/120-volt or 230/240-volt receptacles without tools — just choose the plug that fits the receptacle.

#### MVP™ Adapters



Female Receptacle



#### 254328

For connection to 6-50P receptacle (240 V, 50 A).



#### 254330

For connection to 5-15P receptacle (120 V, 15 A).



#### 254331

For connection to 5-20P receptacle (120 V, 20 A).

For Spectrum 625 X-TREME. Allows connection of machine to 120- or 240-volt receptacles without tools — just choose the adapter cord that fits the receptacle.



Female Receptacle

#### Full KVA Adapter Cord 300517

NEMA 14-50P to NEMA 6-50R. Adapts engine drive 120/240-volt plug to common Millermatic and Spectrum 240-volt plug.

#### 230-Volt Extension Cord 770644

20-foot (6.1 m) NEMA 6-50P to NEMA 6-50R heavy-duty extension cord. 8-gauge cord has lighted ends that show power is on and a molded integrated strain relief.

### Protective Case



#### X-CASE 300184

For Spectrum 375 X-TREME/625 X-TREME.

### Torches

See your Miller distributor for complete information on the following XT plasma torches and their consumables:



#### Spectrum Plasma Cutter Hand-Held Torches

##### For Spectrum 375 X-TREME

**249949** 12 ft. (3.7 m) XT30

##### For Spectrum 625 X-TREME

**260633** 12 ft. (3.7 m) XT40

**260635** 20 ft. (6.1 m) XT40

##### For Spectrum 875 and 875 Auto-Line

**249953** 20 ft. (6.1 m) XT60

**249954** 50 ft. (15.2 m) XT60



#### Spectrum 875 and 875 Auto-Line Plasma Cutter Machine Torches

**249955** 25 ft. (7.6 m) long body XT60M

**249956** 50 ft. (15.2 m) long body XT60M

**257464** 25 ft. (7.6 m) short body XT60M

**263952** 50 ft. (15.2 m) short body XT60M



Each consumable kit includes a storage box.

#### Plasma Torch Consumable Kits

**253520** For XT30 torch. Includes five electrodes, five tips, one swirl ring, one retaining cup, one o-ring and silicone grease.

**253521** For XT40 torch. Includes five electrodes, five 40-amp tips, three 30-amp tips, one 40-amp drag shield, two 30-amp drag shields, one deflector, one o-ring, one swirl ring, one retaining cup, one 40-amp gouge tip, one gouge shield and silicone grease.

**256033** For XT60 torch. Includes three standard electrodes, three standard tips, one drag shield, one deflector, one o-ring, one swirl ring, one retaining cup, one gouge tip, one gouge shield and silicone grease.

**127493** Empty consumable storage box.

## Process Selector Control/Polarity Switch



### Process Selector Control 042872

For CC, CV or CC/CV welding power source. Provides an easy way to change the welding process. Also for

use with dual wire feeders or any application where electrical isolation and/or polarity reversing of weld current is required. Both functions can be used at the same time.

## Remote Controls

Also see Remote Controls in TIG Accessories on pages 124 and 125.



### PRHC-14 Hand Control 195511

For all solid-state power sources after serial number JK674521. Complete current or voltage control brings 120 volts of GFCI power to work area in a single cord. Housed in a durable and light aluminum case and includes 125-foot (38 m) cord with plugs.

## Stick Accessory Kits



### No. 2 Stick Cable Sets

**195196** 15 ft. (4.6 m)

**300836** 50 ft. (15 m)

Consists of either 15- or 50-foot electrode cable with holder and work cable with clamp. 200 A, 100% duty cycle.



### 2/0 Stick Cable Sets

**173851** 50 ft. (15 m), 350 A

**043952** 100/50 ft. (30/15 m), 300 A

Consists of either 50- or 100-foot electrode cable with holder and 50-foot work cable with clamp. 100% duty cycle.



### Weld Cables

**195457** 2/0 cable with electrode holder, 400 A

**195458** 2/0 cable with work clamp, 400 A

**301387** 1/0 cable with electrode holder, 250 A

Consists of a stud/Tweco® adapter and 10-foot (3 m) weld cable with a male Tweco-style plug and either an electrode holder or work clamp.



### 2/0 Weld Cable Extensions

**195456** 50 ft. (15 m)

**195455** 100 ft. (30 m)

Extends weld cables

(**195457**, **195458** and **301387**).

## Submerged Arc Accessories

### Cables



#### SubArc Control Cables

**260622030** 30 ft. (9.1 m)

**260622050** 50 ft. (15 m)

**260622060** 60 ft. (18.3 m)

**260622080** 80 ft. (24.4 m)

**260622100** 100 ft. (30.5 m)

**260622120** 120 ft. (36.6 m)

**260622200** 200 ft. (61.0 m)

Cable between SubArc Interface or Motor Control and power source.



#### Flux Hopper Extension Cables

**260623010** 10 ft. (3 m)

**260623025** 25 ft. (7.6 m)

**260623065** 65 ft. (19.8 m)

Cable between SubArc Interface or Motor Control and flux hopper.



#### Motor Extension Cables

**254232005** 5 ft. (1.5 m)

**254232010** 10 ft. (3 m)

**254232025** 25 ft. (7.6 m)

**254232065** 65 ft. (19.8 m)

Cable between SubArc Interface or Motor Control and drive motor.



#### Continuum Motor/Control Cables

**263368015** 15 ft. (4.6 m)

**263368025** 25 ft. (7.6 m)

**263368050** 50 ft. (15 m)

**263368080** 80 ft. (24.4 m)

**263368100** 100 ft. (30.5 m)

Cable between SubArc Motor Control and SubArc Remote Pendant.



#### SubArc Parallel Cable

**260775015** 15 ft. (4.6 m)



#### SubArc Tandem Cable

**260878015** 15 ft. (4.6 m)

## Torch Accessories

### OBT 600 Torch Body Extensions

**043967** 1 inch (25.4 mm)

**043969** 2 inch (50.8 mm)

**043973** 4 inch (101.6 mm)

**043975** 6 inch (152.4 mm)

### OBT 1200 Torch Body Extension 043981

Overall length with extension is 9 inches (228.6 mm).

Actual length of extension is 8.5 inches (215.9 mm).

### OBT Torch Contact Tips

| OBT 600       | OBT 1200      | Wire Size         |
|---------------|---------------|-------------------|
| <b>192700</b> | <b>192141</b> | 1/16 in. (1.6 mm) |
| <b>192701</b> | <b>199026</b> | 5/64 in. (2.0 mm) |
| <b>192702</b> | <b>192142</b> | 3/32 in. (2.4 mm) |
| <b>192703</b> | <b>200771</b> | 7/64 in. (2.8 mm) |
| <b>192704</b> | <b>192143</b> | 1/8 in. (3.2 mm)  |
| <b>192705</b> | <b>192144</b> | 5/32 in. (4.0 mm) |

### 1200-Amp Twin-Wire Torch Contact Tips

**264595** 3/64 in. (1.2 mm)

**264596** 1/16 in. (1.6 mm)

**264597** 5/64 in. (2.0 mm)

**264588** 3/32 in. (2.4 mm)

## Wire Drive Assembly Accessories

### Drive Rolls

**132955** 1/16 in. (1.6 mm)

**132960** 5/64 in. (2.0 mm)

**132961** 3/32 in. (2.4 mm)

**132962** 7/64 in. (2.8 mm)

**132963** 1/8 in. (3.2 mm)

**193700** 5/32 in. (4.0 mm)



### Single-Wire Straightener 199733

For OBT 600 and OBT 1200 single-wire torches. For 1/16–5/32 inch (1.6–4.0 mm) wire.



### Twin-Wire Straightener 301160

For 1200-amp twin-wire torch only. Single adjustment.



### Manual Single Slide 301137

Provides smooth and accurate movement of the welding heads. Allows for 7.87 inch (200 mm) travel adjustment with load capacity of 220 pounds (100 kg) at 1.64 feet (500 mm). **Not recommended for tandem.**



### Wire Reel 108008

Supports 60-pound (27 kg) coil of wire. Requires Spool Support Assembly (**119438**).

## TIG Accessories

### Kits



A-200 torch with RCCS-14 kit shown.

#### Contractor Kit

**301309** A-150 torch with RFCS-14 HD foot pedal  
**301311** A-150 torch with RCCS-14 fingertip  
**301549** A-200 torch with RFCS-14 HD foot pedal  
**301550** A-200 torch with RCCS-14 fingertip  
 For Maxstar 210/280 and Dynasty 210/280. All-in-one TIG/stick welding kit comes with either a Weldcraft™ A-150 OR A-200 TIG torch, RFCS-14 HD foot control OR RCCS-14 fingertip control, 200-amp stick electrode holder and 300-amp work clamp with 15-foot (4.6 m) cables, flow gauge regulator with 12-foot (3.7 m) gas hose, gas hose coupler, AK2C torch accessory kit, and TIG torch connector.

#### TIG Contractor Kit 301287

For Multimatic 200.

#### 301337

For Multimatic 215.

Kit comes with Weldcraft™ A-150 TIG torch with Dinse-style connector, either a

RFCS-6M foot control (Multimatic 200 kit) OR RFCS-RJ45 foot control (Multimatic 215 kit), flow gauge regulator with 12-foot (3.7 m) gas hose, and AK2C torch accessory kit.

#### Multimatic 235/255 TIG Kit 301518

Kit comes with 25-foot (7.6 m) Weldcraft™ A-150 TIG torch with Dinse-style connector, RFCS-14

HD foot control, 10-pin to 14-pin adapter cord, flow gauge regulator with 5-foot (1.5 m) gas hose, and AK3C torch accessory kit.



W-280 torch kit shown.

#### Weldcraft™ Water-Cooled Torch Kits

**300185** 250 A, W-250 (WP-20)  
**300990** 280 A, W-280 (WP-280)  
**301268** 375 A, W-375  
**300186** 400 A, W-400 (WP-18SC)  
 For Syncrowave 300/400, Maxstar (except 161 models) and Dynasty. Kit comes with 25-foot (7.6 m) TIG torch with Dinse-style connector (thread-lock on 400-amp kit), torch cable cover, work clamp with 15-foot (4.6 m) cable [12-foot (3.7 m) cable on 400-amp kit], flowmeter regulator with gas hose, and gas lens accessory kit.

### Protective Case/Covers



**X-CASE 301429**  
For Maxstar 161 models.



Protective covers (300579) and (301382) shown.

**300579** For Diversion.

**195142** For Syncrowave 210.

**301381** For Maxstar 210.

**301382** For Maxstar 280 and Dynasty 210/280.

### Remote Controls

#### 14-Pin to 6-Pin Adapter Cord 300507

For Multimatic 200 and Maxstar 161 STL/STH. 12-inch (305 mm) cord adapts Miller® 14-pin foot control or fingertip control to a 6-pin plug.

#### 10-Pin to 14-Pin Adapter Cord 301545

For Multimatic 235/255. Allows standard 14-pin TIG remote controls to be used with the Multimatic 235 or Multimatic 255.



**RCC-6M** (6-pin plug)  
**301118** 13.25 ft. (4 m) cord with plug  
 For Multimatic 200 and Maxstar 161 STL/STH.

**RCC-14** (14-pin plug)  
**151086** 26.5 ft. (8 m) cord with plug

East/west rotary-motion fingertip current/contacter control attaches to TIG torch using two hook-and-loop fasteners. Great for production or contractors that need quick ramp-up.



**RCCS-6M** (6-pin plug)  
**195184** 13.25 ft. (4 m) cord with plug  
**195503** 26.5 ft. (8 m) cord with plug  
 For Multimatic 200 and Maxstar 161 STL/STH.

**RCCS-RJ45**  
**301146** 13.25 ft. (4 m) cord with plug  
 For Multimatic 215 and Diversion.

**RCCS-14** (14-pin plug)  
**043688** 26.5 ft. (8 m) cord with plug  
 North/south rotary-motion fingertip current/contacter control attaches to TIG torch using two hook-and-loop fasteners. Great for applications that require a finer amperage control.



**RFCS-RJ45 300432**  
For Multimatic 215 and Diversion. Foot pedal current/contacter control. Includes 14-foot (4.3 m) cord with plug.



**RFCS-6M HD** (6-pin plug)  
**195183** 13.25 ft. (4 m) cord with plug  
**195504** 20 ft. (6 m) cord with plug  
 For Multimatic 200 and Maxstar 161 STL/STH.

**RFCS-14 HD** (14-pin plug)  
**194744** 20 ft. (6 m) cord with plug  
 Heavy-duty foot pedal current/contacter control provides increased stability and durability from larger base and heavier cord. Reconfigurable cord can exit front, back or either side of the pedal for flexibility.



**RHC-14** (14-pin plug)  
**242211020** 20 ft. (6 m) cord with plug  
**242211100** 100 ft. (30.5 m) cord with plug  
 Miniature hand current/contacter control. Dimensions: 4 x 4 x 3.25 inches (102 x 102 x 82 mm).



**RMLS-14** (14-pin plug) **129337**  
 Momentary- and maintained-contact rocker switch for contactor control. Push forward for maintained contact and backward for momentary contact. Includes 26.5-foot (8 m) cord with plug.



**RMS-6M** (6-pin plug) **195269**  
 For Maxstar 161 STL/STH.

**RMS-14** (14-pin plug) **187208**  
 Momentary-contact switch for contactor control. Rubber-covered pushbutton dome switch ideal for repetitive on-off applications. Includes 26.5-foot (8 m) cord with plug.



**RPBS-14** (14-pin plug) **300666**  
 Attaches to the TIG torch to remotely start and stop the TIG welding process. Includes 25-foot (7.6 m) cord with plug.

## Wireless Remote Foot and Hand Controls

See literature AY/6.5 (Foot) and AY/6.6 (Hand)

**Increases productivity, saves money, improves safety and easy to use.**



Wireless 14-pin receiver  
(included with both systems)

Wireless hand control

### Foot control

**Foot control is designed specifically for TIG welding** in manufacturing, fabrication and plant applications, allowing operator to adjust amperage at point of use without the limitations of remote cord.

**Auto on** feature extends the battery life up to 250 hours of welding without turning the pedal on and off.

**Easy-Glide Wear Pads™** glide across concrete, making it easy to reposition the pedal for comfort and speed.

*\*Some applications are not suitable for wireless communication. Keep in mind that the rated range is subjective, and depends on factors such as obstructions, frequency interference, transmission technology, and weather. The figures listed assume ideal conditions are present.*

**Improves productivity and maneuverability** by eliminating cord tangles. Reduces clean up time and work area cord clutter.

**Improves safety** by eliminating control cord and reducing potential trip hazard.

**Improves reliability** by eliminating control cord failure.

**Multiple frequency sharing** allows up to 20 systems to operate in a 90-foot (27.4 m) radius with accuracy and precision — and without delay, system interference, or crosstalk.

**Easy-to-install receiver** plugs directly into the 14-pin receptacle of Miller® machines.

**Easily programmable.** Control can be quickly and easily paired with any other Miller® 14-pin wireless receiver. Control is preprogrammed when purchased with the receiver.

### Hand control

**Hand control is designed for stick, TIG, MIG and flux-cored welding,** allowing operator to adjust parameters for different joint configurations, electrodes and wire types/sizes at the point of use instead of walking back to the machine.

**Allows parameter adjustments up to 300 feet away from welder** without returning to machine.

**Improves weld quality.** Operators can adjust their machines to optimize the parameters for different joint configurations, electrodes, and wire types and sizes.

**Smart Touch™ buttons** allow quick and accurate machine parameter adjustments.

**Digital meter display** allows presetting percentage of machine output before welding, and viewing amperage and voltage while welding.

### Industrial ●

#### Processes

- TIG (GTAW) ▪ Pulsed TIG (GTAW-P)
- Stick (SMAW)<sup>1</sup> ▪ MIG (GMAW)<sup>1,2</sup>
- Flux-cored (FCAW)<sup>1,2</sup>

<sup>1</sup>With wireless hand control only.

<sup>2</sup>Only with voltage-sensing feeder.

#### Comes complete with

- Wireless foot control (300429) OR hand control (300430) transmitter
- Wireless 14-pin receiver (300722)
- Battery box (249297)
- Three AA batteries
- Four Easy-Glide Wear Pads™ (for foot control only) (sold individually, 248274)
- Belt clip (for hand control only) (249233)

#### Suggested power sources



Look throughout this catalog for the icon above signifying compatibility with a wireless remote.

| Model/Stock Number                           | Component                  | Power Supply       | Battery Life | Rated Range*    | Temperature                    | Radio Frequency    | RF Power | Antenna  | Dimensions           | Weight            |
|--|----------------------------|--------------------|--------------|-----------------|--------------------------------|--------------------|----------|----------|----------------------|-------------------|
| <b>Wireless Foot Control System (300429)</b> | Foot control (transmitter) | Three AA batteries | 250 hours    | 90 ft. (27.4 m) | -13° to +158°F (-25° to +70°C) | 2.4 Ghz (ISM band) | <3 mW    | Internal | H: 6 in. (152 mm)    | 3 lb. (1.4 kg)    |
| <b>Wireless Hand Control System (300430)</b> | Hand control (transmitter) | Three AA batteries | 250 hours    | 300 ft. (91 m)  |                                |                    |          |          | H: 5 in. (127 mm)    | 0.6 lb. (0.27 kg) |
|  |                            |                    |              |                 |                                |                    |          |          | D: 11.5 in. (292 mm) | w/batteries       |
|  |                            |                    |              |                 |                                |                    |          |          | H: 5 in. (127 mm)    | 0.6 lb. (0.27 kg) |
|  |                            |                    |              |                 |                                |                    |          |          | W: 2.75 in. (70 mm)  | w/batteries       |
|  |                            |                    |              |                 |                                |                    |          |          | D: 1.375 in. (35 mm) | w/batteries       |

### TIG Accessories (continued)

#### Torch and Weld Cable Connectors

##### Air-Cooled TIG (GTAW) Torch Connectors



**273483<sup>1,2</sup>**  
For Multimatic 200/215/220 and Maxstar 161.  
25 mm (small) Dinse-style gas thru for one-piece air-cooled torches.



**194723** A-200 (WP26)  
**194722<sup>2</sup>** All others  
For Syncrowave 210.  
50 mm Dinse-style gas thru for one-piece air-cooled torches.



**195379** A-200 (WP26)  
**195378<sup>2</sup>** All others  
For Multimatic 255, CST, Syncrowave 300/400, Maxstar 210/280/400 and Dynasty 210/280/400.  
50 mm Dinse-style for one-piece air-cooled torches.

#### Water-Cooled TIG (GTAW) Torch Connectors



**50 mm Dinse-Style Flow Thru 195380**  
For Syncrowave 210.  
Used with all Weldcraft™ water-cooled torches.



**50 mm Dinse-Style with Water Return Line 195377**  
For Syncrowave 300/400, Maxstar 210/280/400 and Dynasty 210/280/400.  
Used with all Weldcraft™ water-cooled torches.



**50 mm Thread-Lock-Style 225028**  
For Maxstar/Dynasty 800.  
Used with all Weldcraft™ water-cooled torches.



**Thread-Lock-Style Weld Cable Connectors 225029**  
For Maxstar/Dynasty 800.  
Contains two male connectors that accept #1/0 to #4/0 AWG size cable.

<sup>1</sup>Except A-200 (WP26) torches. <sup>2</sup>A-80 (WP24) torches require 24-5 adapter.

## Wire Feeder Accessories

### Extension Cables (14-Pin)

#### 8-Conductor Cables

**242208025** 25 ft. (7.6 m)

**242208050** 50 ft. (15 m)

**242208080** 80 ft. (24.4 m)

For SuitCase 12RC, 20 Series and 70 Series (except MPa Plus) feeders. For 14-pin remote controls and 24 VAC wire feeders. 14-pin plug to a 14-pin socket. Not for 115-volt XR feeders.

#### 11-Conductor Cables

**247831025** 25 ft. (7.6 m)

**247831050** 50 ft. (15 m)

**247831080** 80 ft. (24.4 m)

For XR-AlumaFeed SuitCase and MPa Plus feeders.

Eleven conductors to support contactor control and remote voltage control on all Miller® electronic constant-voltage (CV) 14-pin power sources. Additional functions supported when using the AlumaPower MPa, Invision MPa or XMT MPa power sources include synergic pulsed MIG, remote process select and side select capabilities.

#### 14-Conductor Cables

**242205025** 25 ft. (7.6 m)

**242205050** 50 ft. (15 m)

For HDC and WC-115 weld controls. Fully-loaded 14-pin extension cables for remote controls, and 24-volt and 115-volt feeders.

## Power Supply Adapter



### PSA-2 Control 141604

Required when using SuitCase 12RC, 20 Series or 70 Series feeders with power sources having only 115-volt power available. Control is equipped with a 14-pin receptacle and a 10-foot (3 m) interconnecting cord with Hubbell

connections for older-style power sources. Can also be used with competitive power sources requiring a contact closure for contactor control.

### PSA-2 Extension Cord 047813

25-foot (7.6 m) cord extends 10-foot (3 m) cord supplied with PSA-2 control (4-pin to 4-pin connection).

## Spool Adapter

### 047141

For use with 14-pound (6.4 kg) spool of Hobart or Lincoln self-shielding wire.

## Spool Gun Controls and Kits

For more information on SGA 100 and SGA 100C see literature M/1.5.



### SGA 100 043856

Required to connect Spoolmate 3035 spool gun to a Millermatic 141/211. Also allows connection to virtually any similar MIG welder

— Miller or other brands. Includes 10-foot (3 m) 115-volt power cable with plug, 6-foot (1.8 m) interconnecting cable, and 5-foot (1.5 m) gas hose.



### SGA 100C 043857

SGA with contactor required to connect Spoolmate 3035 spool gun to CV engine drives like the Miller Bobcat. Includes 10-foot (3 m) 115-volt power cable with plug, 6-foot (1.8 m)

interconnecting cable, and 5-foot (1.5 m) gas hose.

For more information on WC-115A and WC-24 see literature M/1.73 or M/1.76.



### WC-115A Weld Control

**137 546** Without contactor

**137546011** With contactor

Operates on 115-volt power and designed primarily for constant-current DC power sources. Can also be used with constant-voltage (CV) power sources or DC engine drives supplying 115 volts. Used with a constant-current (CC) source the control circuit functions in a voltage-sensing mode, and with a CV source it functions as a constant-speed circuit. Includes wire run-in and drive motor acceleration controls which ensure optimum arc starting performance.



### WC-24 Weld Control 137549

For Spoolmate 200, Spoolmatic and Spoolmatic Pro. Easily mounts on power source. Designed for use with Miller® constant-voltage (CV) power sources with 14-pin receptacles and supplying 24 VAC.

## Spool Gun Extension Hose and Cable Kits

**132228** 25 ft. (7.6 m)

**132229** 50 ft. (15 m)

For Spoolmate 200, Spoolmatic and Spoolmatic Pro.

Extends leads, etc. between spool gun and power source.

## Turntable Assembly

**146236**

Allows feeder to rotate as operator changes work position. Reduces strain and bending of gun cable.

## Wire Straightener



**141580** For .035-.045 inch (0.9-1.1 mm) wire

**141581** For 1/16-1/8 inch (1.6-3.2 mm) wire

For 20 Series and 70 Series.

# For All Your Industrial MIG Gun and Consumable Needs

We've merged our catalogs and our websites to provide one source for all your semi-automatic, robotic, and fixed automatic MIG welding gun and consumable needs.

Visit us online today at **Tregaskiss.com** to access product information, use our online product configurators and learn how to get more out of your welding applications. While you're there you can **request a hard copy of the new Bernard and Tregaskiss MIG Welding Guns and Consumables catalog** or **sign up for Amperage**, our electronic newsletter.

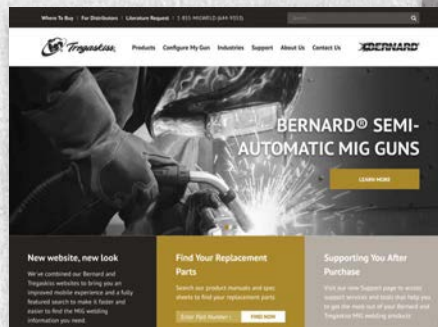

**Tregaskiss.com**



**Miller recommends**



**It's the tie that binds**



Finding the right filler metal solution for your welding needs is critical in an industry that is about getting the job done right. Filler metals are more than just a component of welding — they are **the tie that binds science and people**. The right solutions. Solutions to make our world more secure. More dynamic. More of what you need.

Every day, every project, every weld is another opportunity for Hobart to earn and secure your trust by helping you find the right filler metal solution.

That kind of help and finding your welding solutions is our passion.

Visit **HobartBrothers.com** for more information.

**SCIENCE + PEOPLE**

















**Find Your Solution. Today.**

**Index** *New!* or *Improved!* products appear in blue type.

|   |  |   |  |
|---|--|---|--|
| <b>A</b> AlumaFeed Welding Systems . . . . . 11 | <b>D</b> Dynasty 400 . . . . . 58              | <b>M</b> MDX Series MIG Guns . . . . . 24     | <b>T</b> 20 Series Bench Feeders . . . . . 20      |
| ArcReach Heater . . . . . 92                    | Dynasty 800 . . . . . 58                       | MIGmatic M-Series MIG Guns . . . . . 23       | Thunderbolt 160 . . . . . 49                       |
| ArcReach Smart Feeder . . . . . 18/47           | <b>F</b> FILTAIR 130 . . . . . 103             | Millermatic 141 . . . . . 7                   | Thunderbolt 210 . . . . . 49                       |
| ArcReach Stick/TIG Remotes . . . . . 47         | FILTAIR 4000-12000 . . . . . 106               | Millermatic 211 . . . . . 7                   | Tregaskiss Guns and Peripherals . . . . . 34       |
| ArcReach SuitCase Feeders . . . . . 18/47       | FILTAIR 4000-12000 Accessories . . . . . 107   | Millermatic 252 . . . . . 8                   | Fixed Automatic Guns . . . . . 34                  |
| ArcStation 30FX/60SX . . . . . 115              | FILTAIR Capture 5 . . . . . 104                | Millermatic 255 . . . . . 9                   | Robotic Guns . . . . . 34                          |
| AugmentedArc System . . . . . 117               | FILTAIR MWX Series . . . . . 104               | Millermatic 350P . . . . . 10                 | TOUGH GUN TT3 Reamers . . . . . 35                 |
| Auto-Continuum Systems . . . . . 16             | FILTAIR SWX Series . . . . . 105               | Millermatic 350P Aluminum . . . . . 10        | Welding Consumables . . . . . 35                   |
| <b>B</b> Bernard MIG Guns . . . . . 25          | Fusion 160 . . . . . 73                        | Multimatic 200 . . . . . 37                   | <b>Trailblazer Series</b> . . . . . 78             |
| BTB MIG Guns . . . . . 25                       | <b>G</b> Gas Equipment . . . . . 96            | Multimatic 215 . . . . . 37                   | Trailblazer 302 Air Pak . . . . . 81               |
| Dura-Flux Guns . . . . . 26                     | Gas Mixers . . . . . 102                       | Multimatic 220 AC/DC . . . . . 38             | Trailers . . . . . 121                             |
| Fume Extraction Guns . . . . . 26               | Heavy-Duty Outfits . . . . . 100               | <b>Multimatic 235</b> . . . . . 39            | <b>W</b> Weldcraft Series TIG Torches . . . . . 59 |
| Welding Consumables . . . . . 25/26             | <b>Medium-Duty Outfits</b> . . . . . 101/102   | Multimatic 255 . . . . . 40                   | Air-Cooled Torches . . . . . 60                    |
| <b>Big Blue 400 PipePro</b> . . . . . 82        | Regulators . . . . . 96/97/98                  | <b>O</b> OpenBook . . . . . 116               | Automation Torches . . . . . 66                    |
| <b>Big Blue 400 Pro</b> . . . . . 81            | Torches . . . . . 99                           | <b>P</b> PerformArc Robotic                   | Specialty Torches . . . . . 65                     |
| <b>Big Blue 450 Duo CST</b> . . . . . 82        | <b>I</b> Insight ArcAgent . . . . . 70/71      | Welding Systems . . . . . 30                  | Torch Accessories . . . . . 67                     |
| <b>Big Blue 500 Pro</b> . . . . . 83            | Insight Centerpoint . . . . . 71               | PipeWorx 400 Welding System . . . . . 48      | Tungsten . . . . . 66                              |
| <b>Big Blue 600 Series</b> . . . . . 83         | Insight Core . . . . . 70                      | ProHeat Induction Heating . . . . . 90        | Water-Cooled Torches . . . . . 63                  |
| <b>Big Blue 800 Series</b> . . . . . 84         | Intellex Feeders and Swingarc . . . . . 13     | <b>S</b> 70 Series Bench Feeders . . . . . 20 | Welding Safety and Health . . . . . 103            |
| Blue Star 185 . . . . . 73                      | Invision MPA Plus Systems . . . . . 14         | 70 Series Remote Configurations . . . . . 22  | Apparel/Jackets . . . . . 114                      |
| Bobcat 200 Air Pak . . . . . 75                 | <b>J</b> Jetline Fixed Automation . . . . . 32 | 70 Series Swingarc . . . . . 22               | Gloves . . . . . 113                               |
| <b>Bobcat Series</b> . . . . . 76               | <b>L</b> LiveArc System . . . . . 117          | Spectrum Series . . . . . 94                  | <b>Face Shields</b> . . . . . 113                  |
| <b>C</b> Continuum Systems . . . . . 15         | <b>L</b> LiveArc System . . . . . 117          | Spoolmate Spool Guns . . . . . 27             | <b>Helmets</b> . . . . . 110/111                   |
| Coolmate Coolant Systems . . . . . 119          | <b>M</b> Maxstar 161 S . . . . . 49            | Spoolmatic Spool Guns . . . . . 28            | Helmet Accessories . . . . . 110/111/112           |
| <b>CST 282</b> . . . . . 51                     | Maxstar 161 STL/STH . . . . . 53               | SubArc Digital Series . . . . . 86            | Respiratory . . . . . 108/109                      |
| <b>CST 282 Racks</b> . . . . . 51               | Maxstar 210 Series . . . . . 56                | SubArc Components . . . . . 87/88             | Safety Glasses . . . . . 112                       |
| <b>D</b> Deltaweld Systems . . . . . 12         | Maxstar 210 STR . . . . . 50                   | SubArc Portable Welding System . . . . . 89   | Weld-Mask . . . . . 112                            |
| Dimension 650/650 ArcReach . . . . . 46         | Maxstar 280 Multiprocess . . . . . 41          | SubArc 3-Wheel Tractor . . . . . 89           | <b>Wireless Remote Controls</b> . . . . . 80/125   |
| Diversion 180 . . . . . 53                      | Maxstar 280 Series . . . . . 56                | SuitCase 12RC Feeder . . . . . 18             | <b>X</b> XMT 350 FieldPro Systems . . . . . 44     |
| Dynasty 210 Series . . . . . 56                 | Maxstar 400 . . . . . 58                       | Syncrowave 210 . . . . . 54                   | XMT 450 CC/CV ArcReach . . . . . 45                |
| Dynasty 280 DX Multiprocess . . . . . 41        | Maxstar 800 . . . . . 58                       | Syncrowave 300 . . . . . 55                   | XMT Racks . . . . . 45                             |
| Dynasty 280 Series . . . . . 56                 |  | <b>Syncrowave 400</b> . . . . . 55            | XMT Series . . . . . 42                            |
|   |  |   | XR Push-Pull Guns . . . . . 21/29                  |

# WE BUILD™ CONNECTIONS

## Contents

|  |   |
|--|---|
| <b>INTRO</b>   | New from Blue <b>3</b><br>Benefits of Blue <b>4</b> |
|    | MIG (GMAW) <b>6</b>                                 |
|    | Wire Feeders <b>17</b>                              |
|    | MIG Guns <b>23</b>                                  |
|    | Automation <b>30</b>                                |
|    | Multiprocess <b>36</b>                              |
|    | Stick (SMAW) <b>49</b>                              |
|    | TIG (GTAW) <b>52</b>                                |
|    | Welding Intelligence™ <b>69</b>                     |
|   | Engine-Driven <b>72</b>                             |
|  | Submerged Arc <b>86</b>                             |
|  | Induction Heating <b>90</b>                         |
|  | Plasma Cutters <b>93</b>                            |
|  | Gas Equipment <b>96</b>                             |
|  | Welding Safety and Health <b>103</b>                |
|  | Workstations <b>115</b>                             |
|  | Training Solutions <b>116</b>                       |
|  | Accessories <b>118</b>                              |

## GET CONNECTED

### ▶ Video Library

Subscribe to our YouTube channel for how-to videos that provide you the guidance and inspiration you need to tackle real-life welding applications and projects.

### ▶ Project Gallery

Browse our extensive project gallery — whether you're just looking for inspiration, or for projects with specific plans for building them. Find and share welding projects for home or work.

### ▶ Protect Your Investment

Register your product for product updates and proof of ownership.

### ▶ Product Reviews

Customer reviews can help you decide which product is best for you. And after you've made a purchase, post a review to help others make a great choice.

### ▶ Newsletters

Subscribe to our informative email newsletters written for do-it-yourselfers, professionals, instructors and safety specialists.

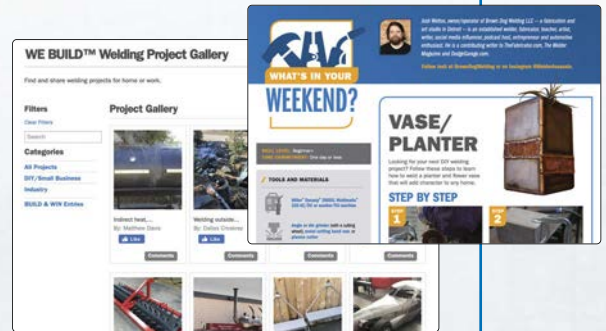

## MillerWelds.com

Your trusted destination for welding resources, helpful support and high-performance products for all of your projects.

Together, we build connections.



Distributed By:

